

HILLSBOROUGH

Community College



October 2009

**College President As of
11/02/2009**

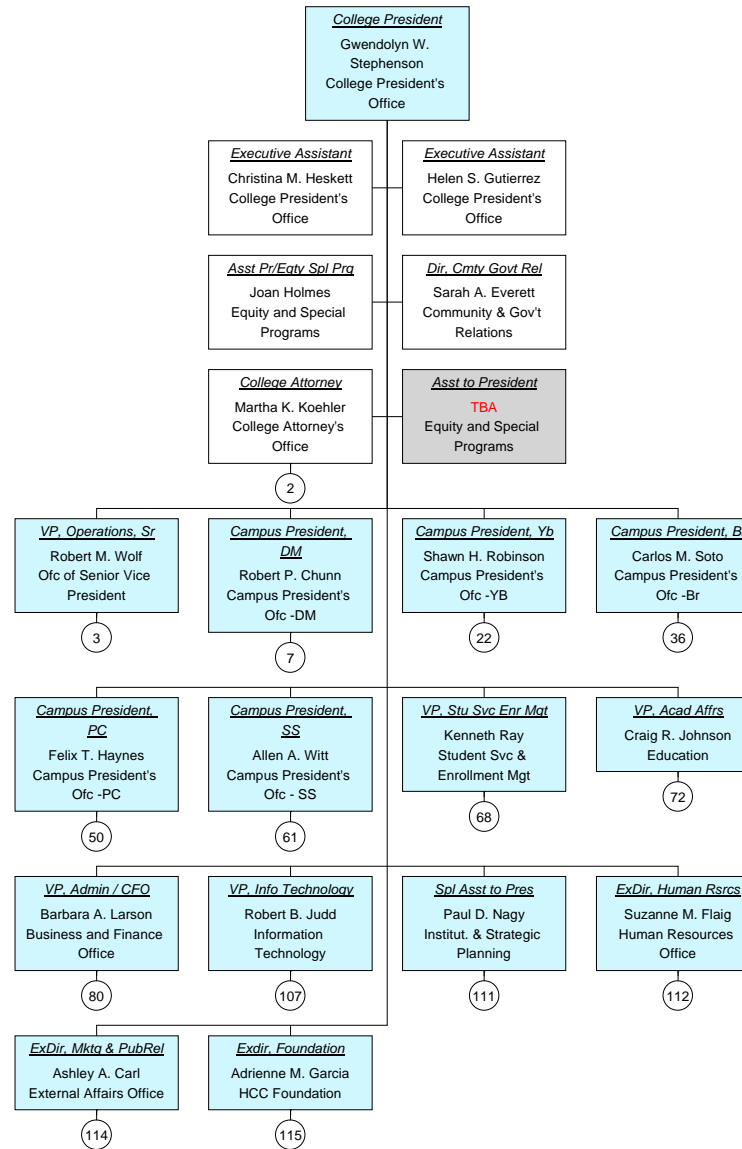

Vacant Position
Cabinet Position



**College Attorney As of
11/02/2009**

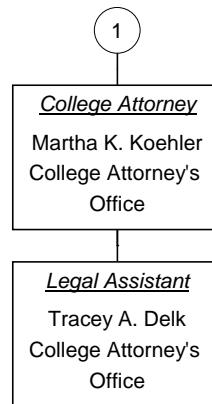

■ Vacant Position
■ Cabinet Position

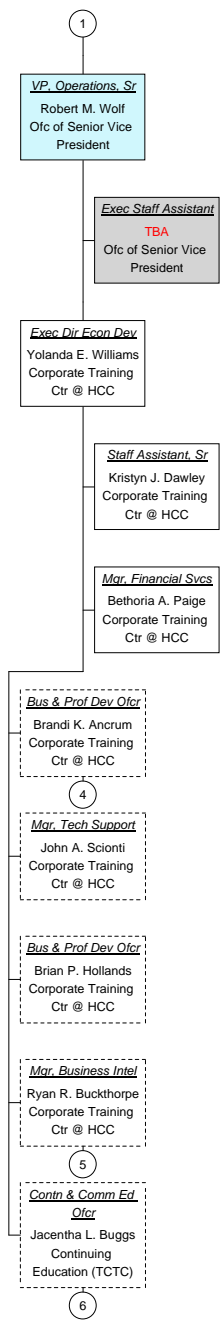

 Vacant Position
 Cabinet Position



**Bus & Prof Dev Ofcr As of
11/02/2009**

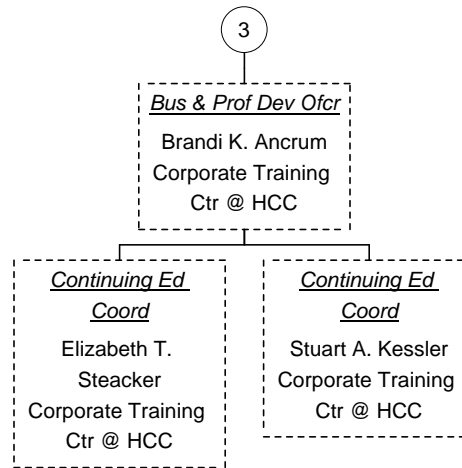

■ Vacant Position
■ Cabinet Position



**Mgr, Business Intel As of
11/02/2009**

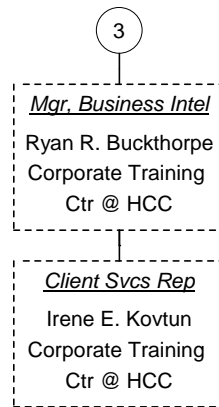

■ Vacant Position
■ Cabinet Position



**Contn & Comm Ed Ofcr As of
11/02/2009**

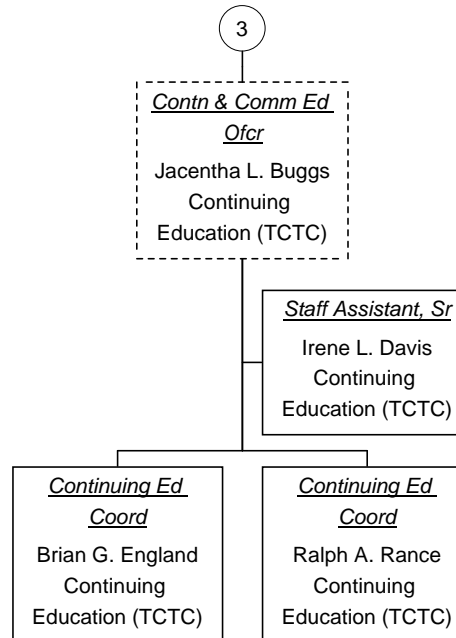

■ Vacant Position
■ Cabinet Position

Campus President, DM As of 11/02/2009

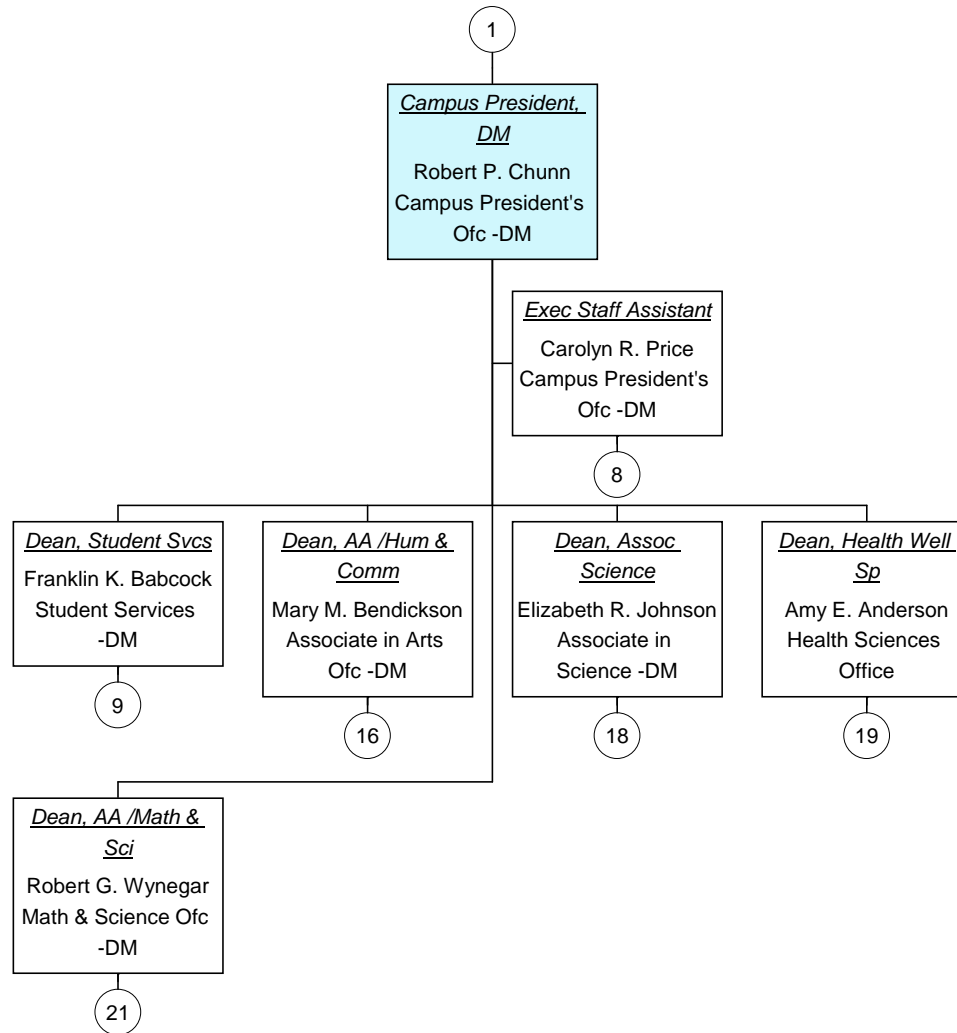

Vacant Position
 Cabinet Position



**Exec Staff Assistant As of
11/02/2009**

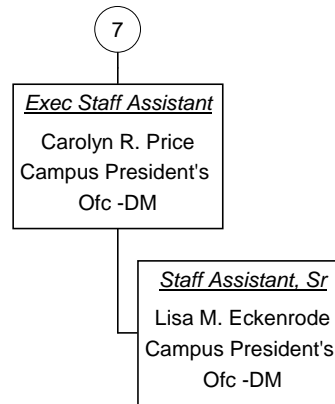

■ Vacant Position
■ Cabinet Position



Dean, Student Svcs As of
11/02/2009

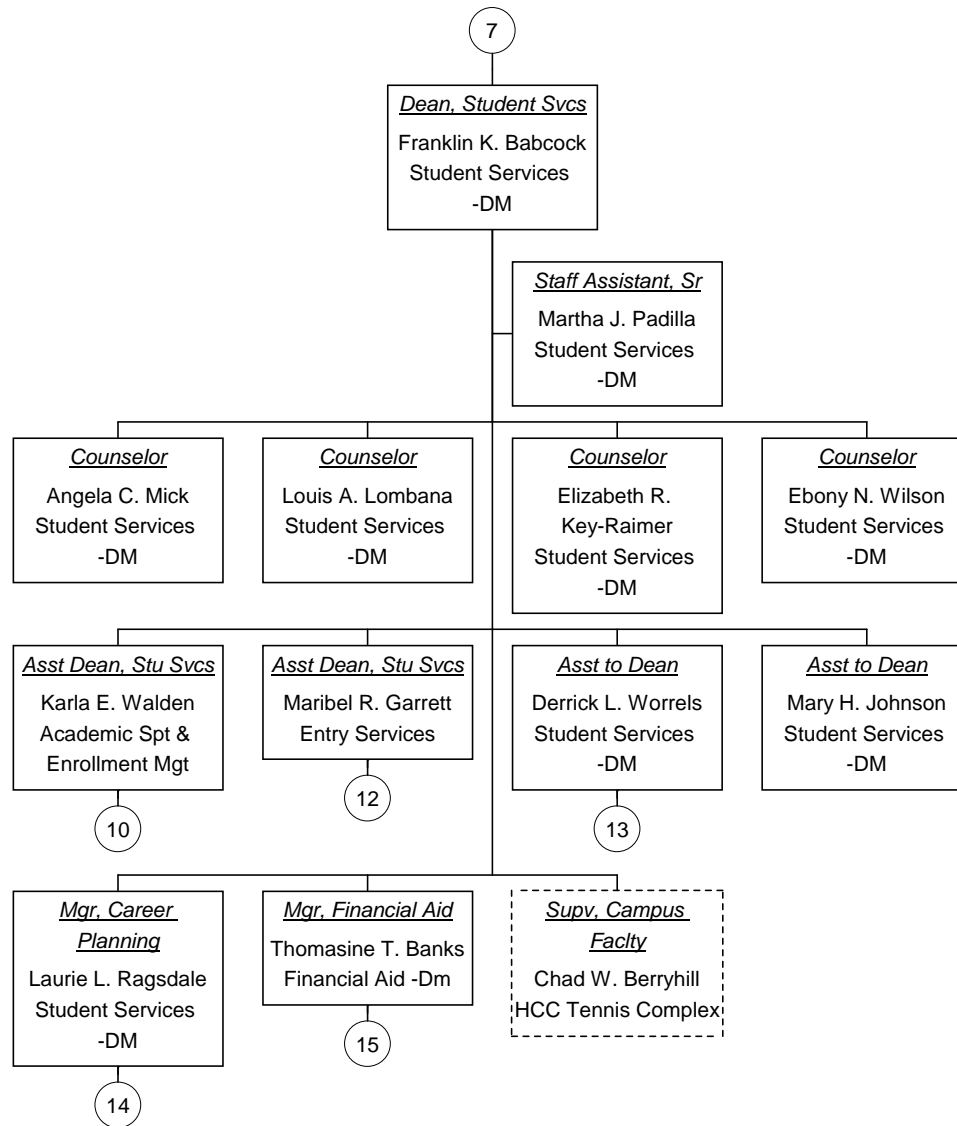

Vacant Position
 Cabinet Position



**Asst Dean, Stu Svcs As of
11/02/2009**

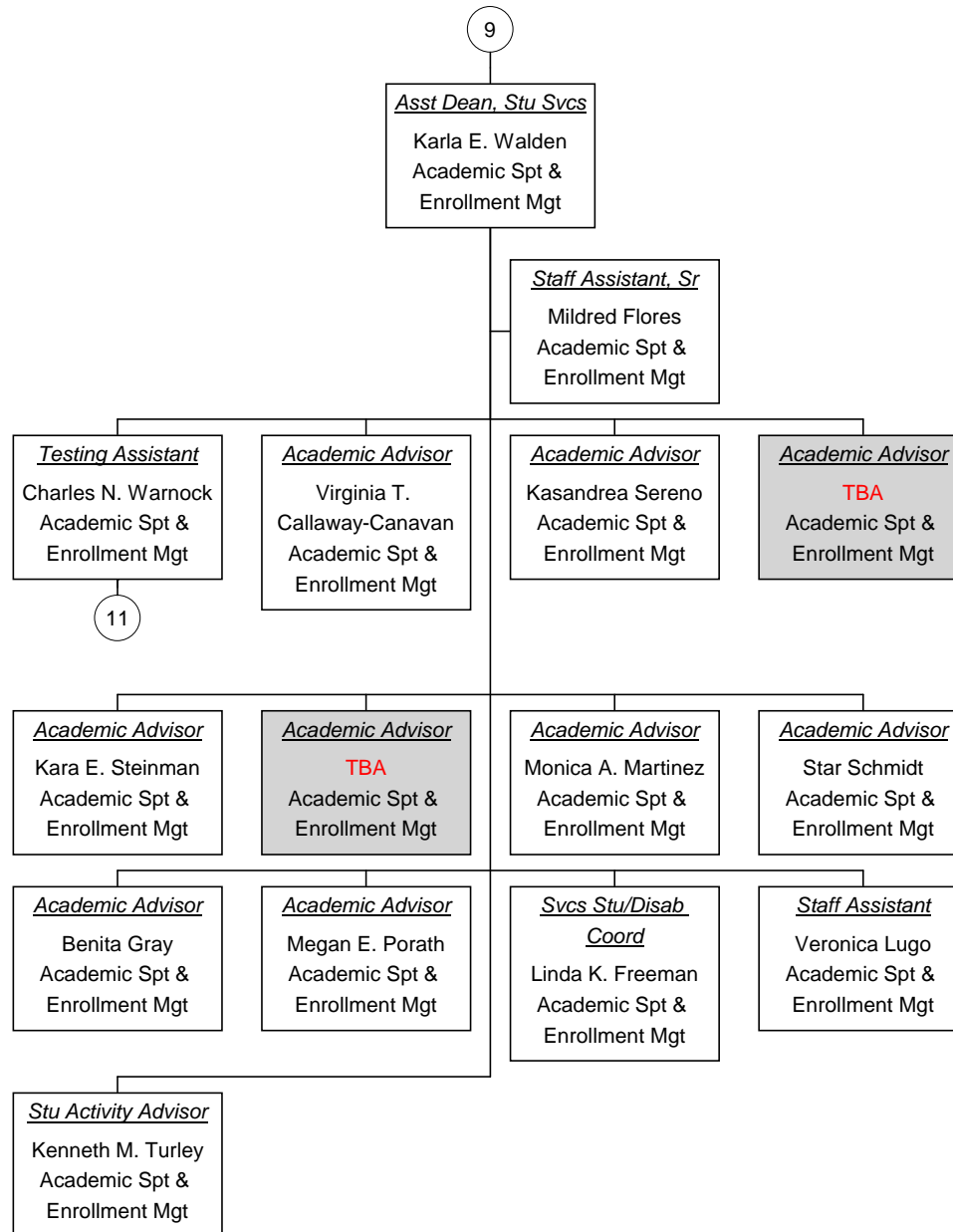

Vacant Position
 Cabinet Position



Testing Assistant As of 11/02/2009

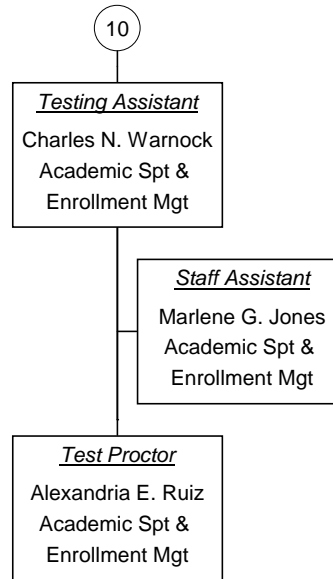

■ Vacant Position
■ Cabinet Position



**Asst Dean, Stu Svcs As of
11/02/2009**

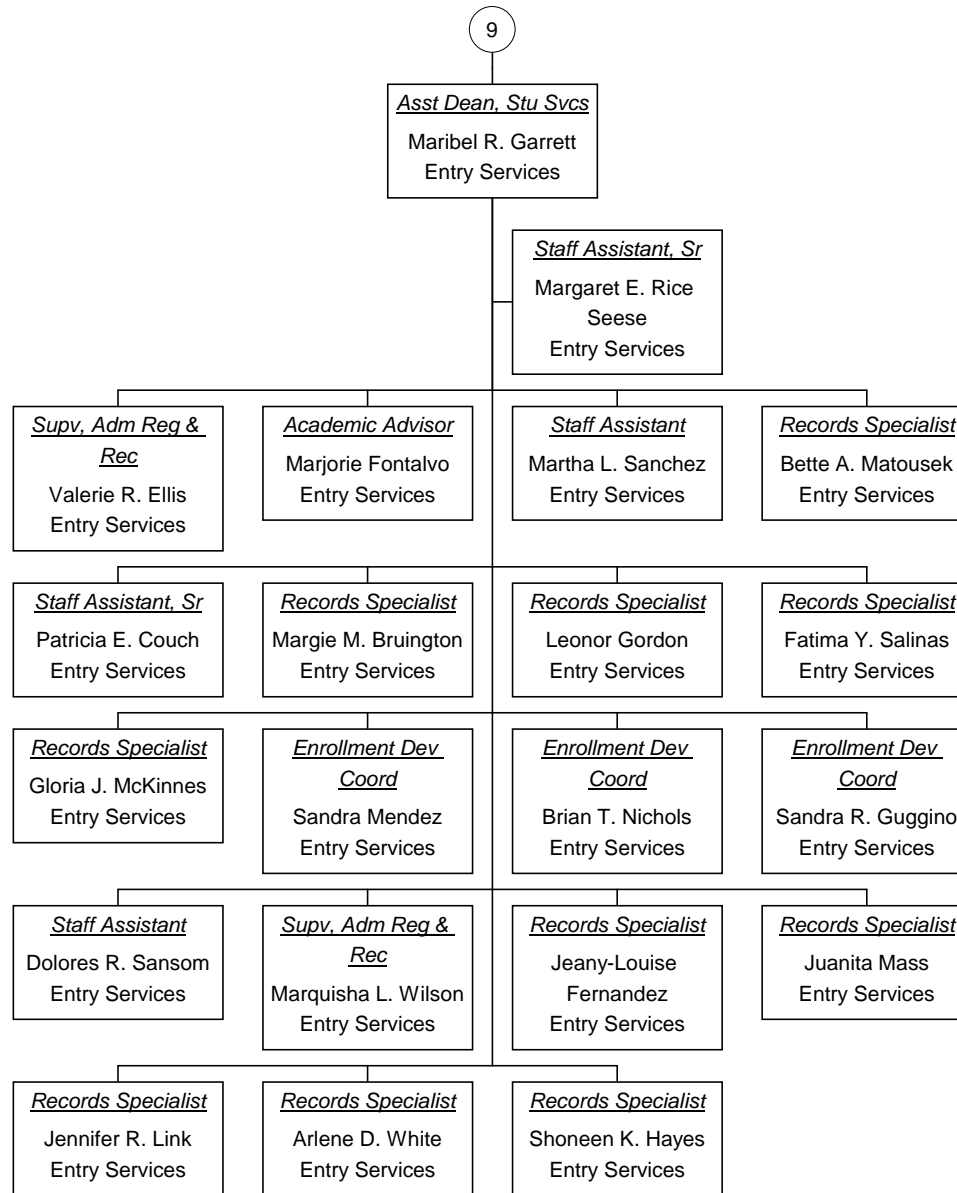

Vacant Position
 Cabinet Position



Asst to Dean As of 11/02/2009

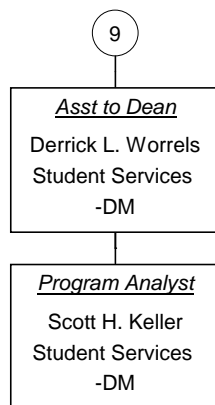

■ Vacant Position
■ Cabinet Position



**Mgr, Career Planning As of
11/02/2009**

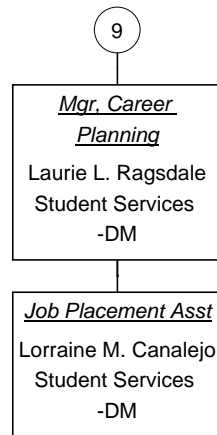

■ Vacant Position
■ Cabinet Position



**Mgr, Financial Aid As of
11/02/2009**

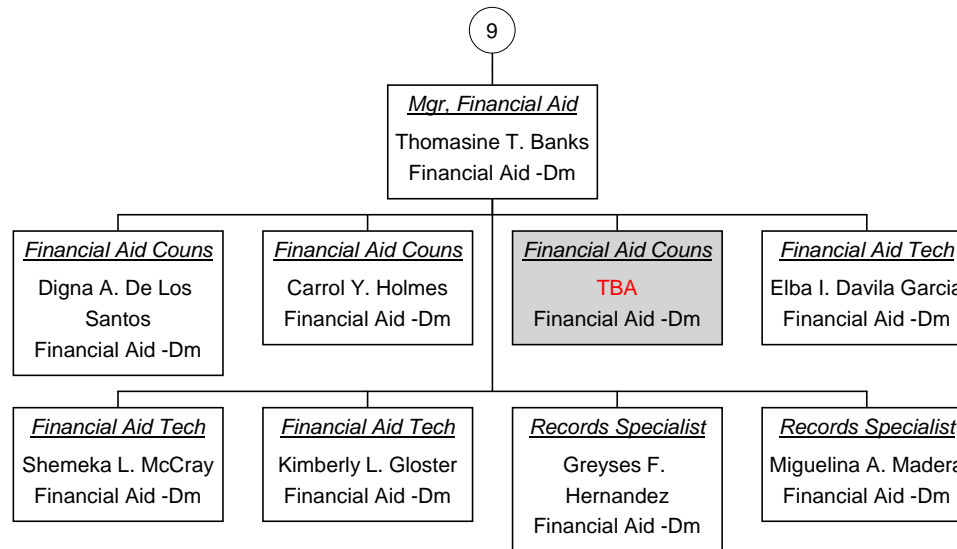

Vacant Position
 Cabinet Position



Asst to Dean As of 11/02/2009

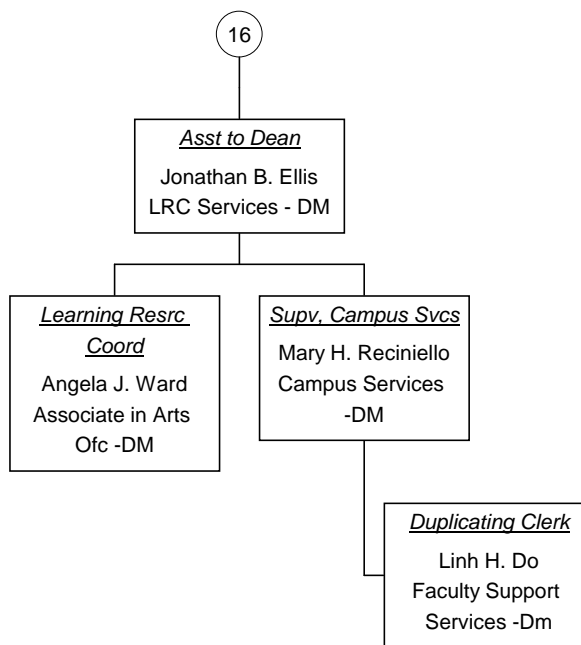

Vacant Position
Cabinet Position



Dean, Assoc Science As of
11/02/2009

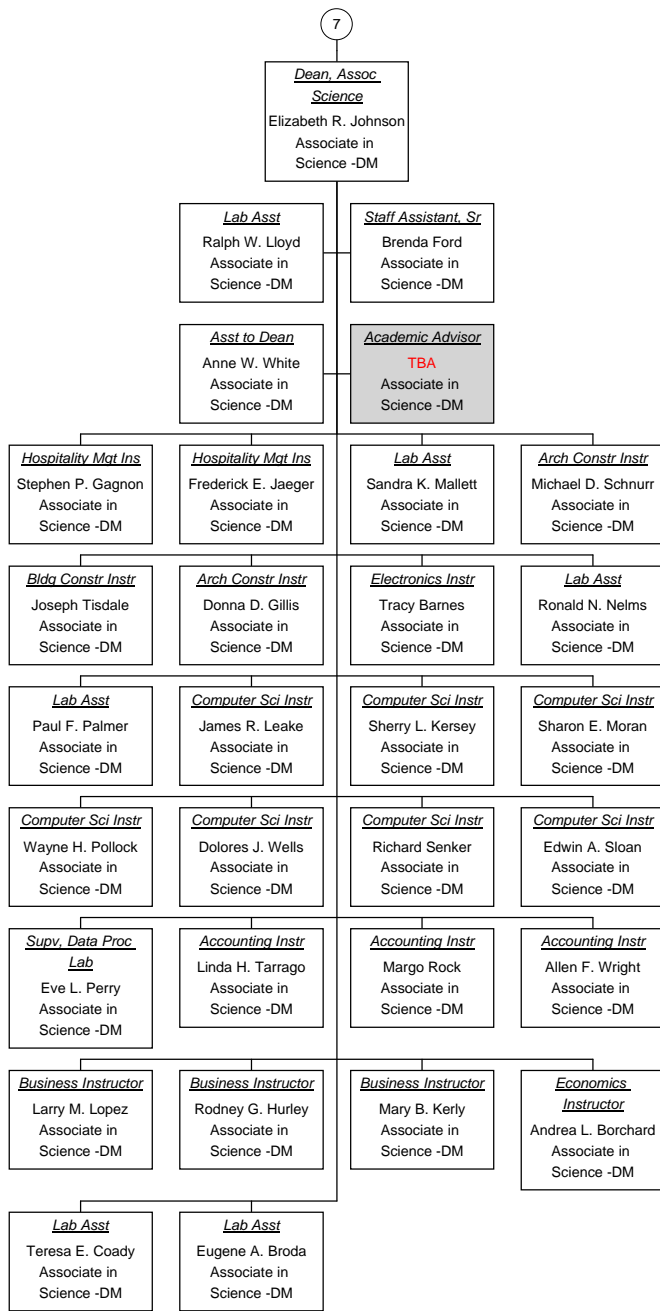

Vacant Position
Cabinet Position

Dean, Health Well Sp As of
11/02/2009

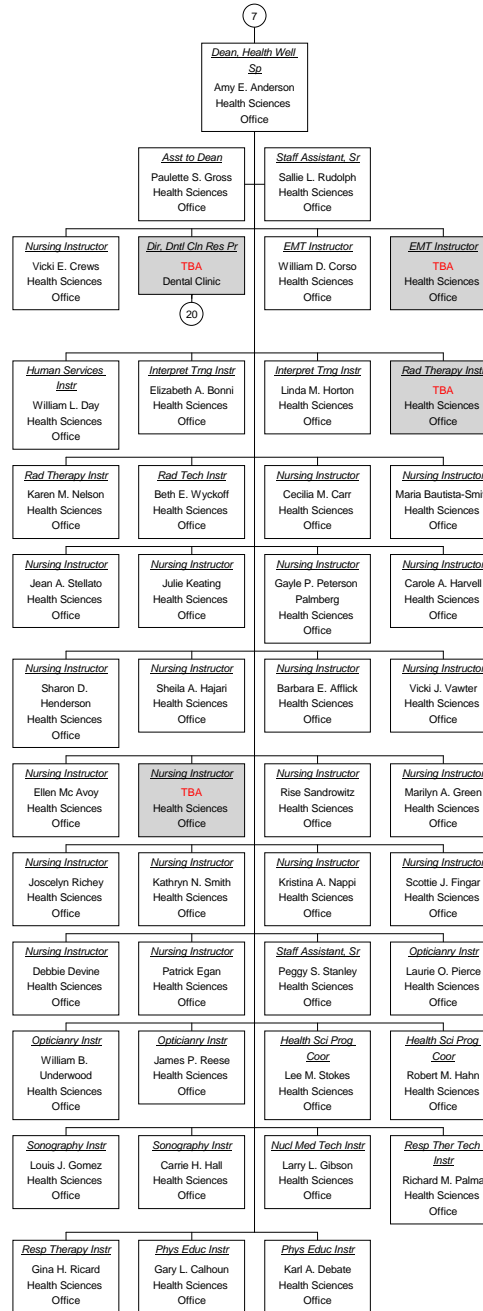

Vacant Position
Cabinet Position



**Dir, Dntl Cln Res Pr As of
11/02/2009**

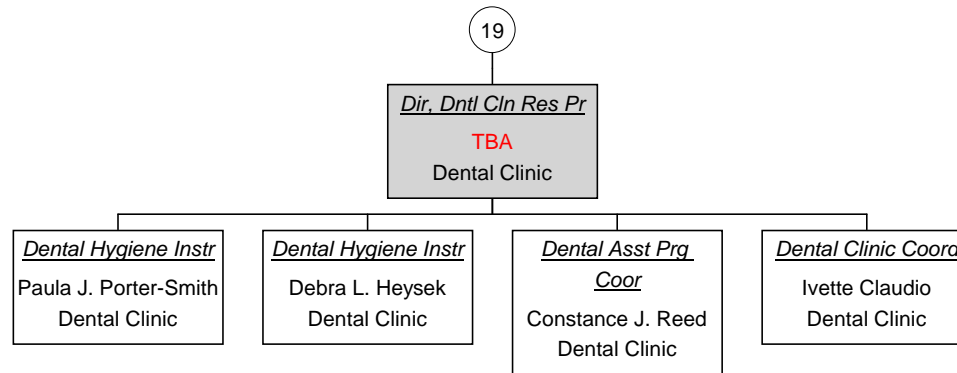

■ Vacant Position
■ Cabinet Position

Dean, AA/Math & Sci As of
11/02/2009

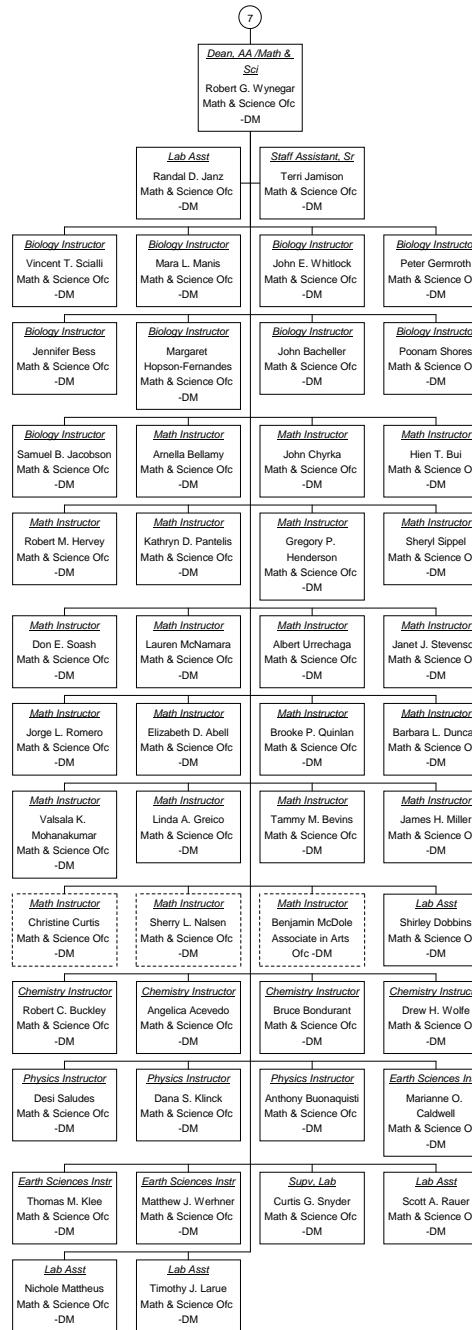

Vacant Position
Cabinet Position



**Campus President, Yb As of
11/02/2009**

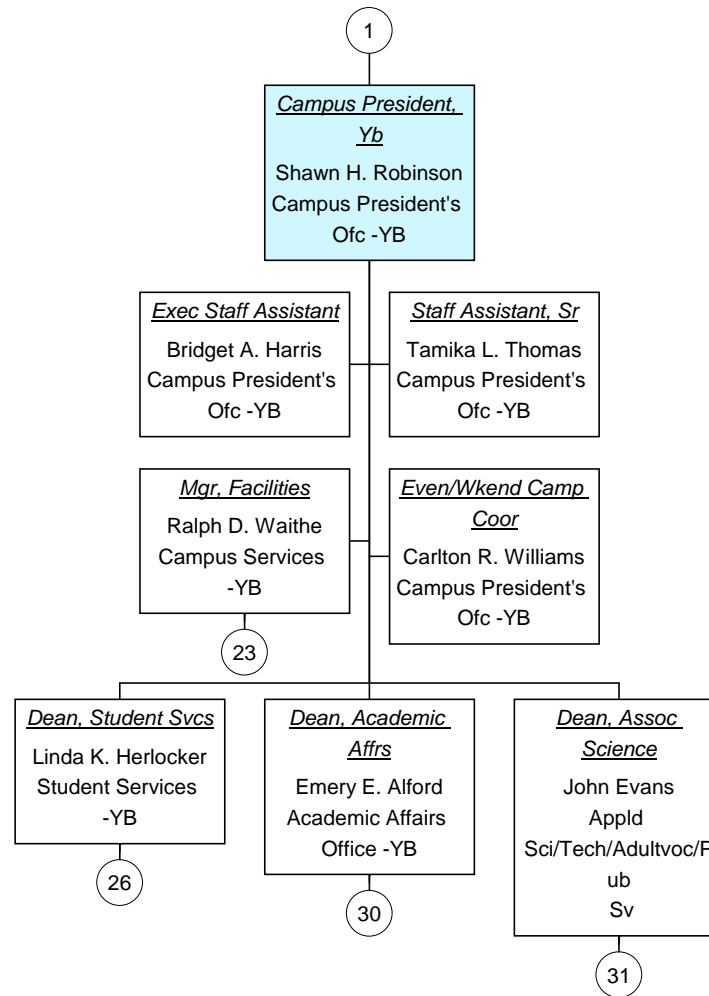

Vacant Position
 Cabinet Position



Mgr, Facilities As of 11/02/2009

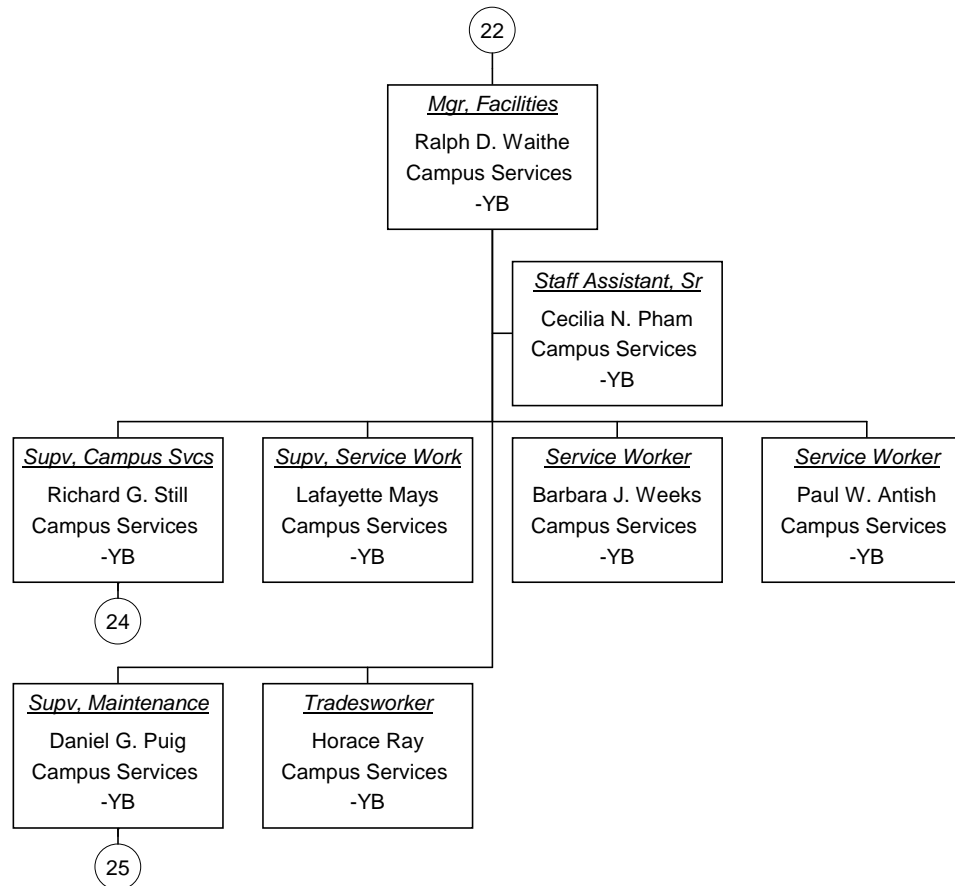

Vacant Position
 Cabinet Position



**Supv, Campus Svcs As of
11/02/2009**

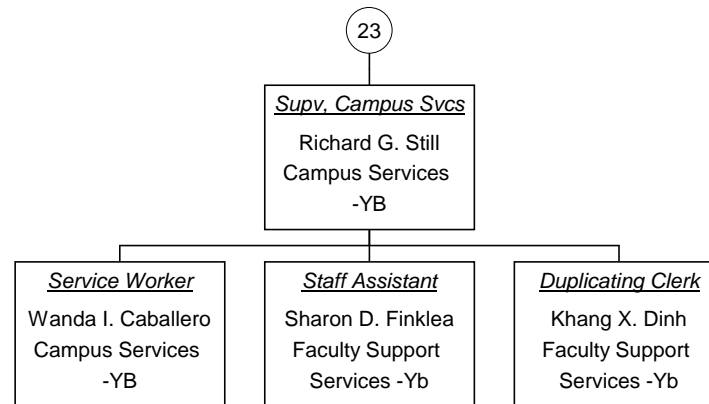

■ Vacant Position
■ Cabinet Position



Supv, Maintenance As of 11/02/2009

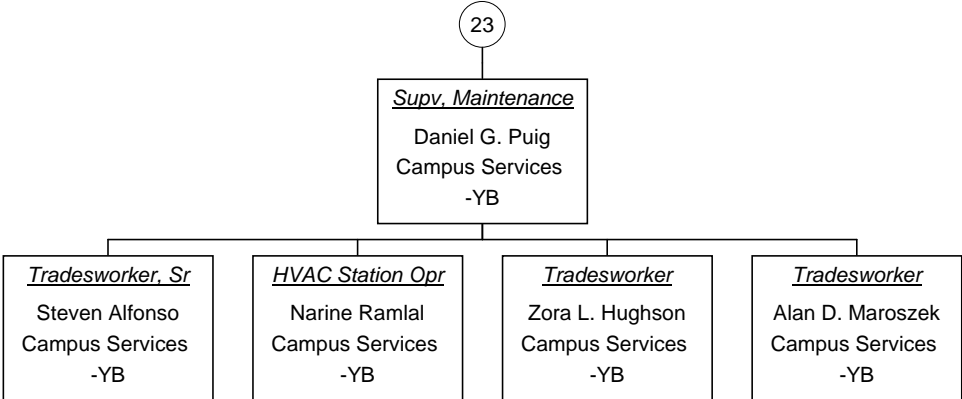

Vacant Position
 Cabinet Position



**Dean, Student Svcs As of
11/02/2009**

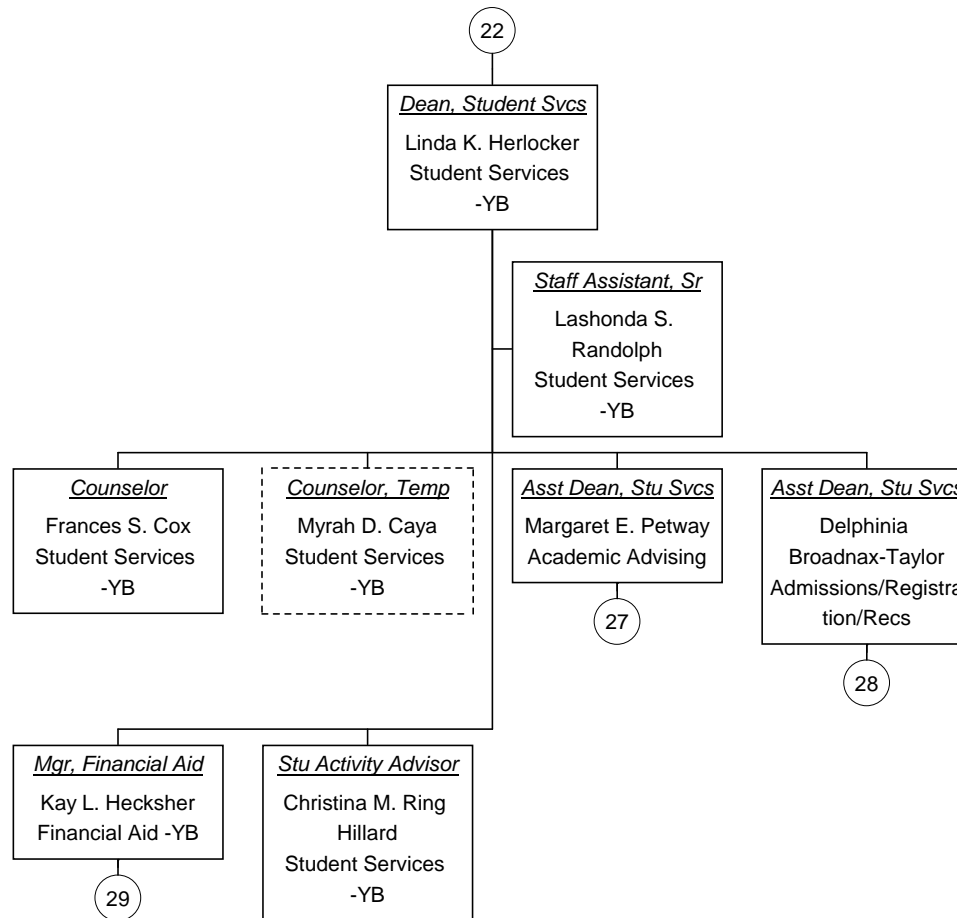

Vacant Position
 Cabinet Position



**Asst Dean, Stu Svcs As of
11/02/2009**

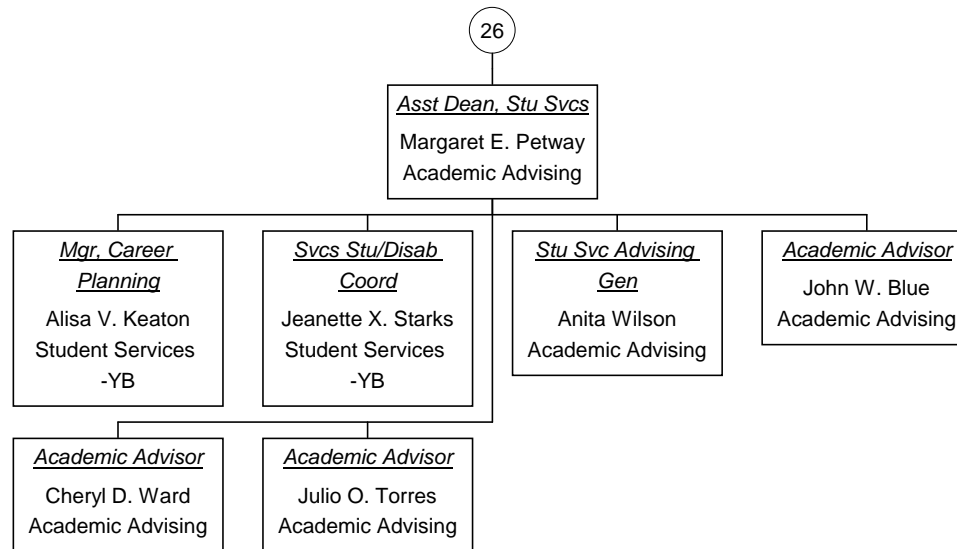

Vacant Position
 Cabinet Position



**Asst Dean, Stu Svcs As of
11/02/2009**

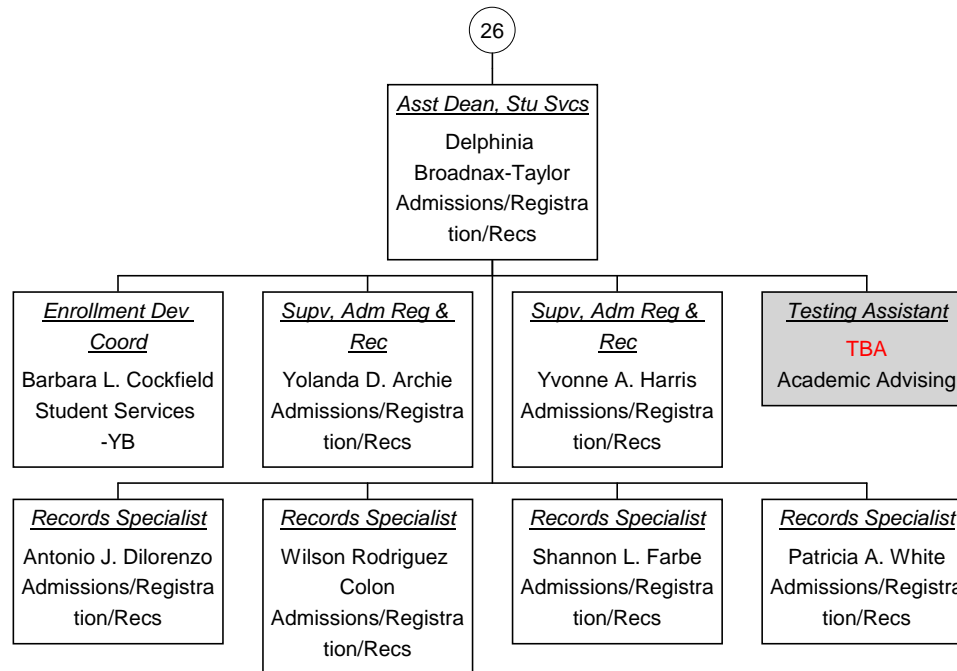

Vacant Position
 Cabinet Position



**Mgr, Financial Aid As of
11/02/2009**

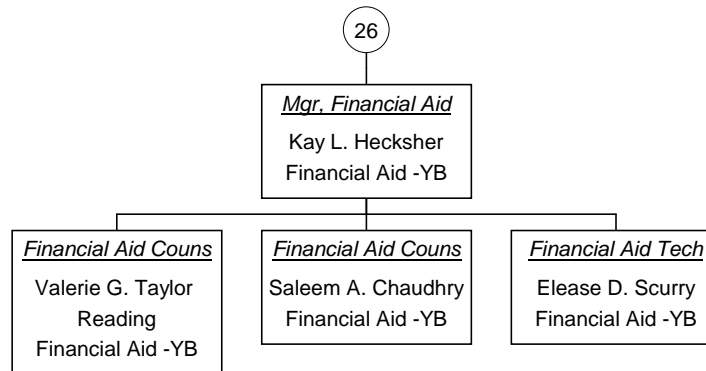

■ Vacant Position
■ Cabinet Position

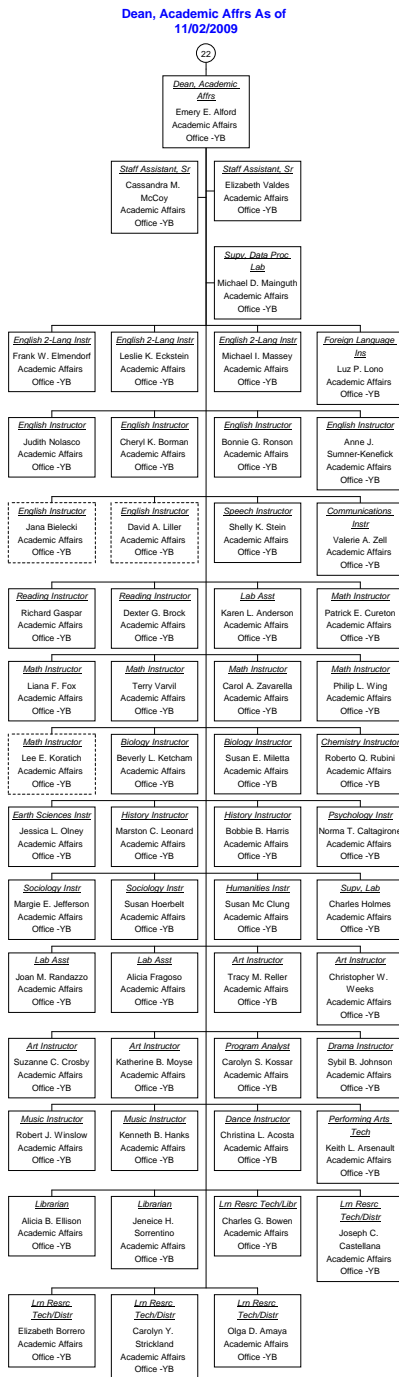

Vacant Position
Cabinet Position

Dean, Assoc Science As of
11/02/2009

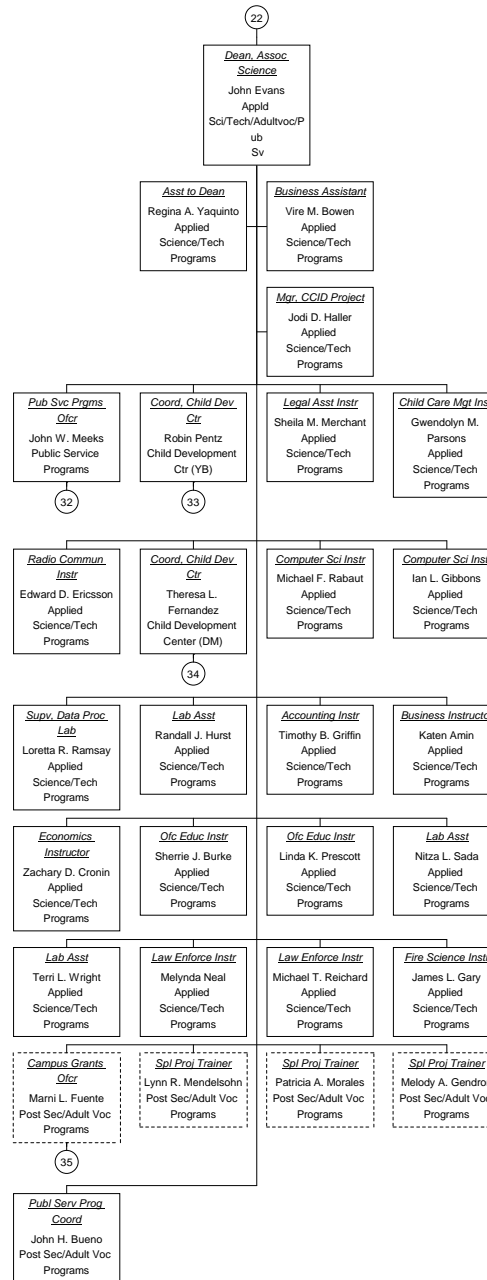

Vacant Position
Cabinet Position



**Pub Svc Prgms Ofcr As of
11/02/2009**

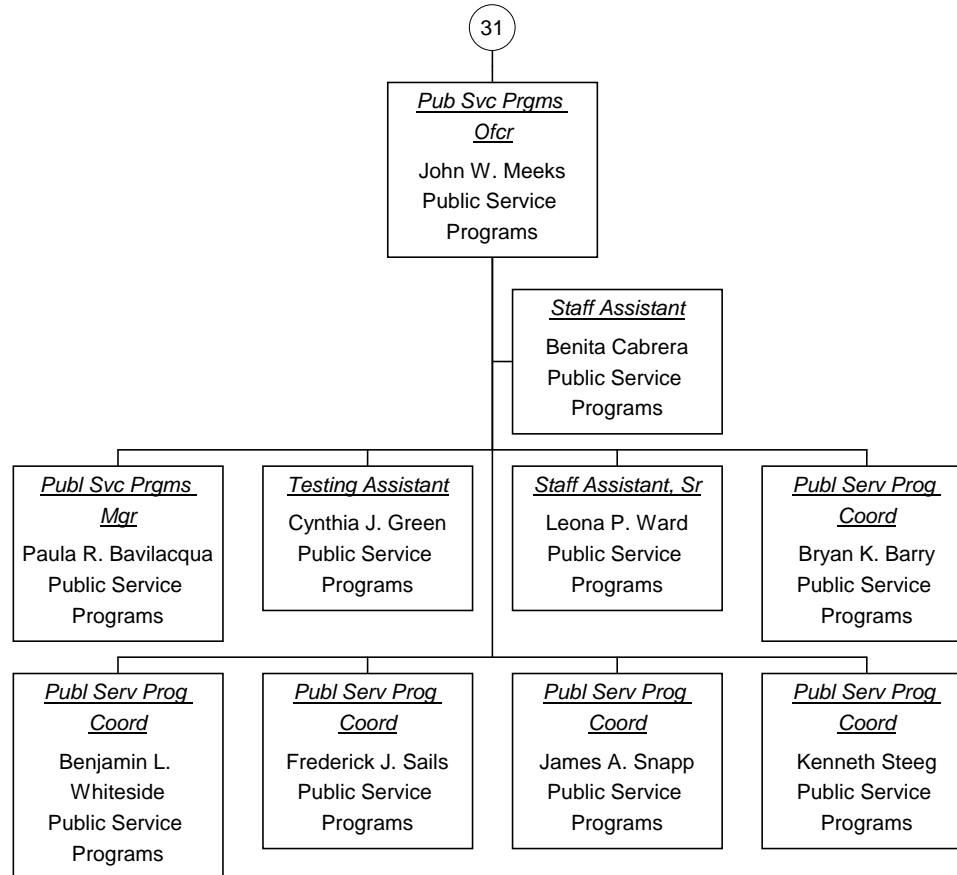

Vacant Position
 Cabinet Position



**Coord, Child Dev Ctr As of
11/02/2009**

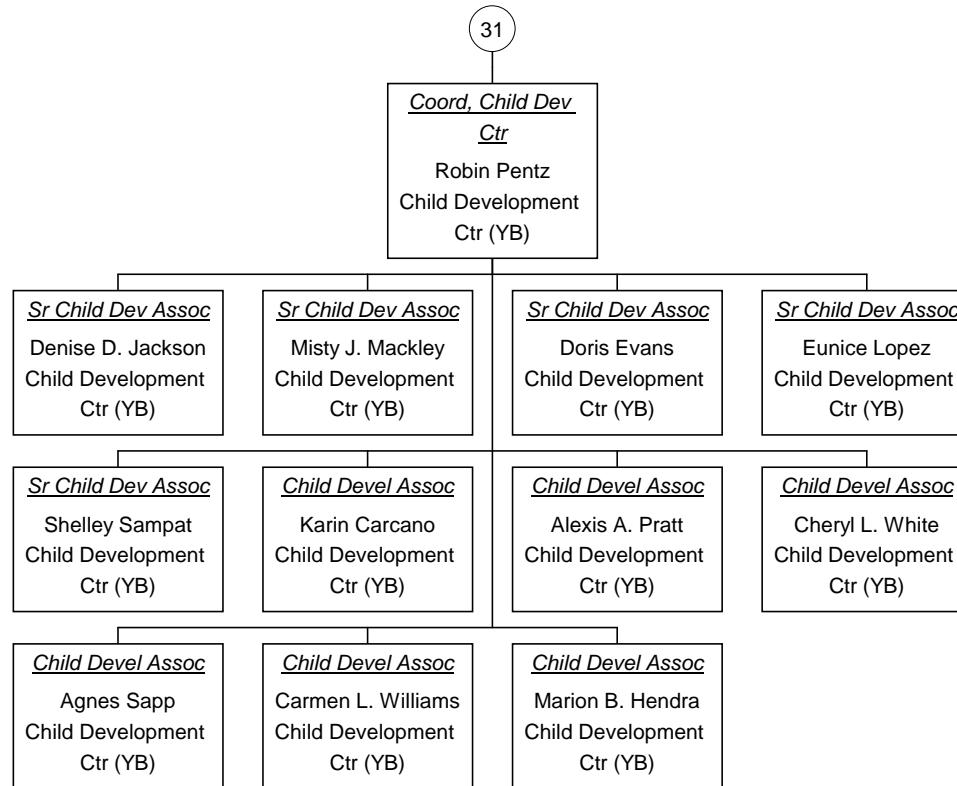

Vacant Position
 Cabinet Position



**Coord, Child Dev Ctr As of
11/02/2009**

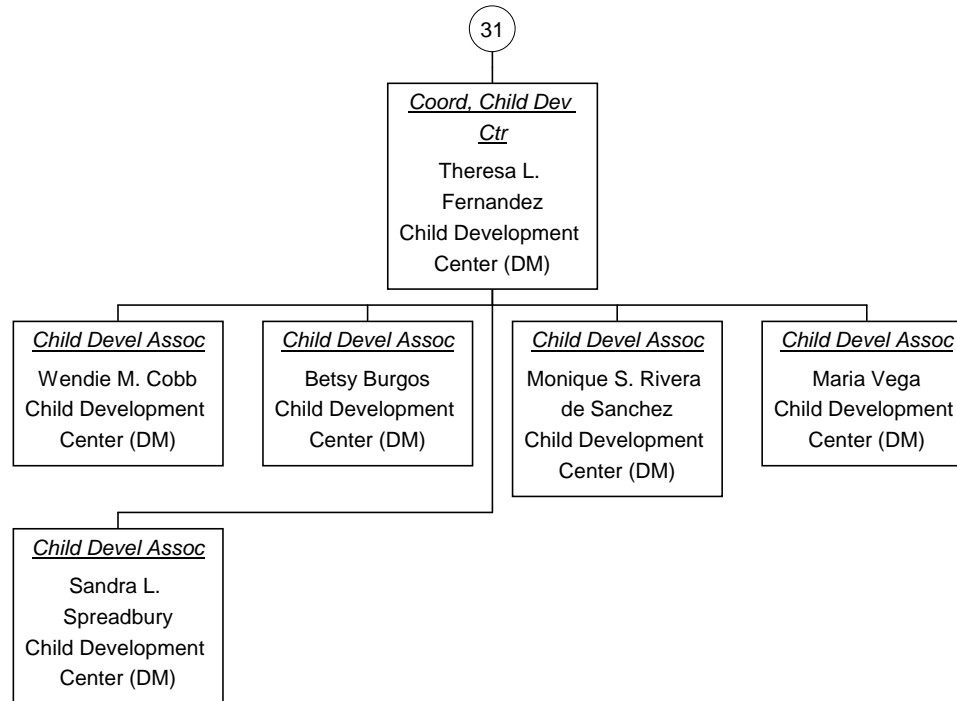

■ Vacant Position
■ Cabinet Position



**Campus Grants Ofcr As of
11/02/2009**

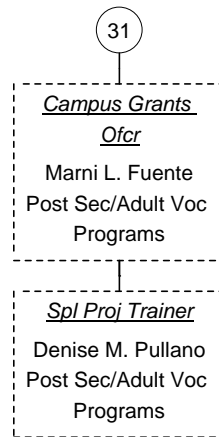

■ Vacant Position
■ Cabinet Position



Campus President, Br As of 11/02/2009

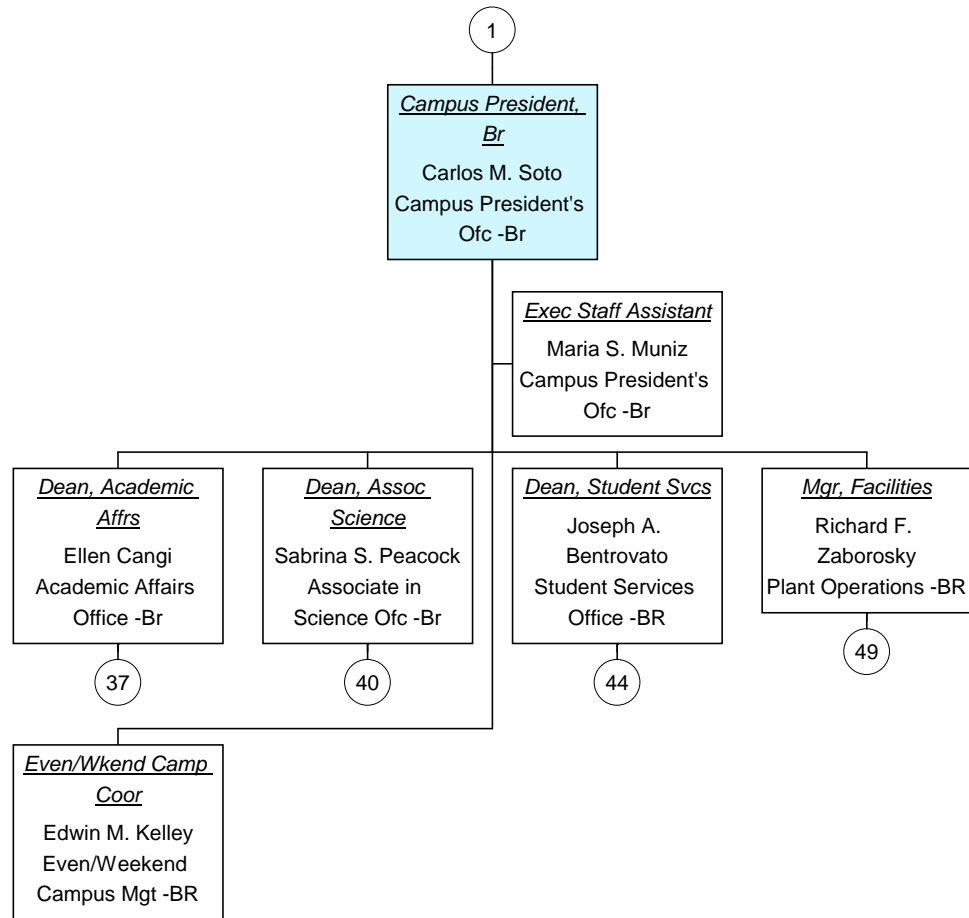

Vacant Position
 Cabinet Position

Dean, Academic Affrs As of
11/02/2009

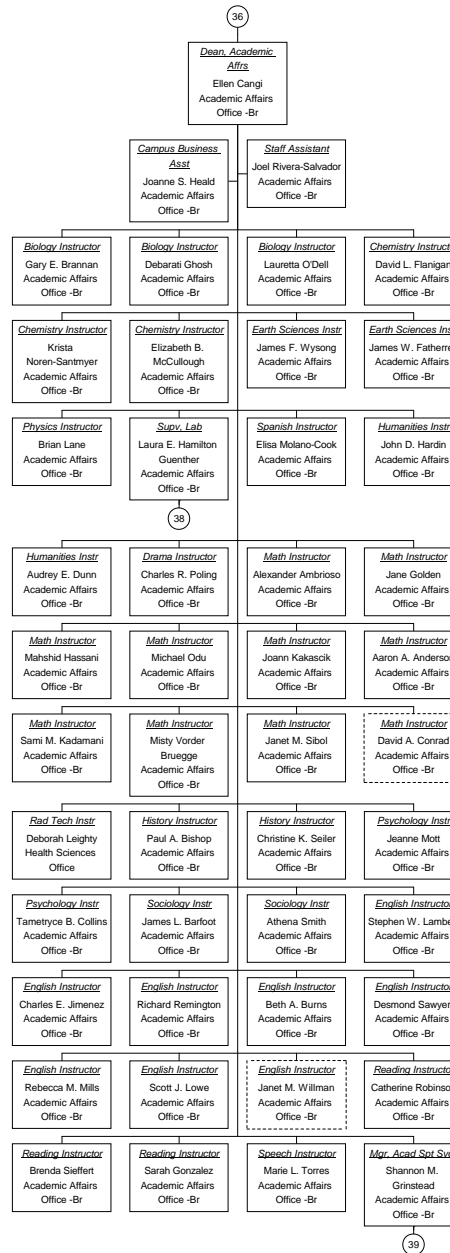

Vacant Position
Cabinet Position



Supv, Lab As of 11/02/2009

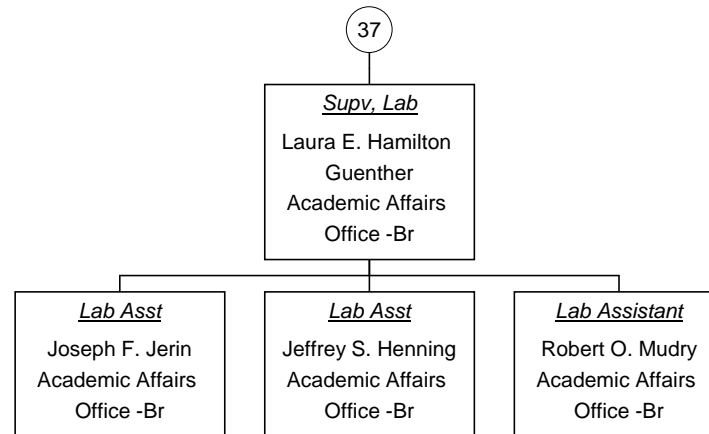

Vacant Position
Cabinet Position



**Mgr, Acad Spt Svcs As of
11/02/2009**

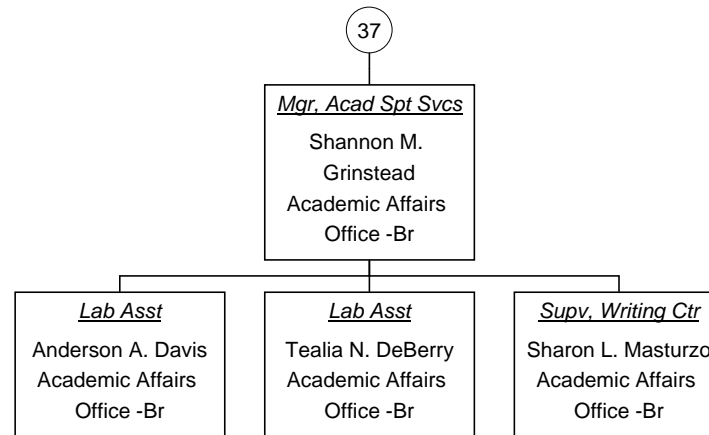

■ Vacant Position
■ Cabinet Position



Dean, Assoc Science As of
11/02/2009

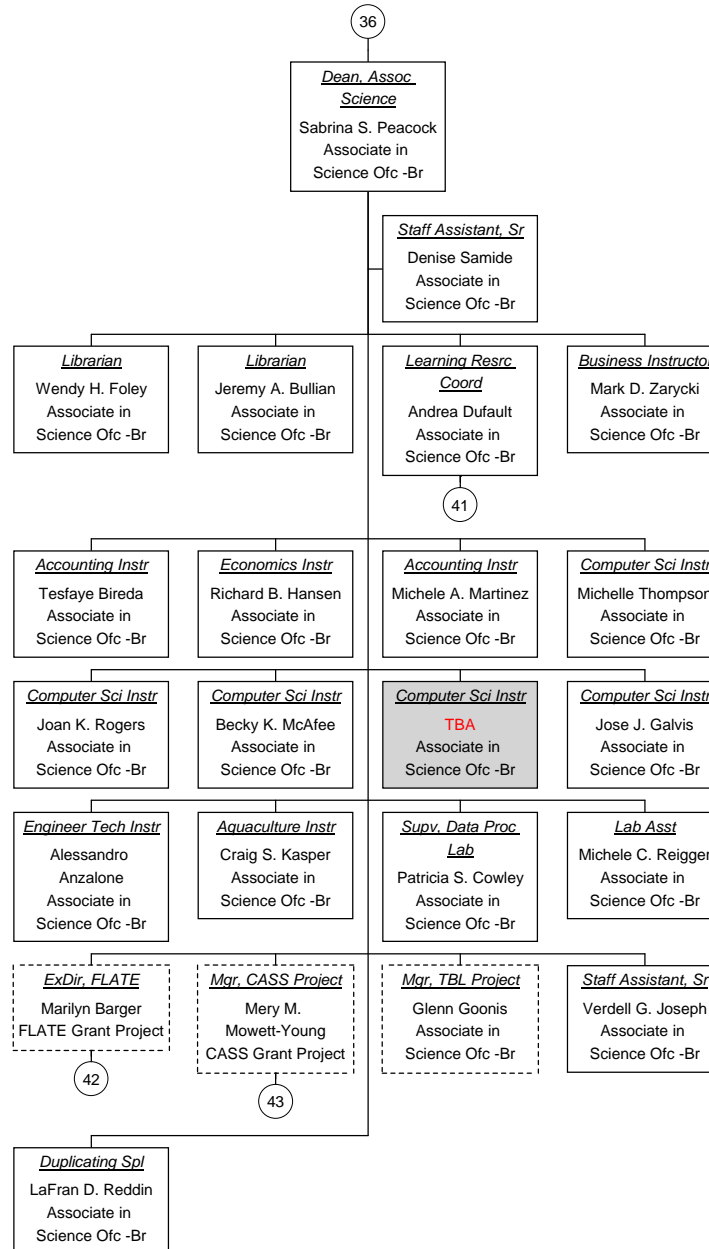

Vacant Position
 Cabinet Position



Learning Resrc Coord As of 11/02/2009

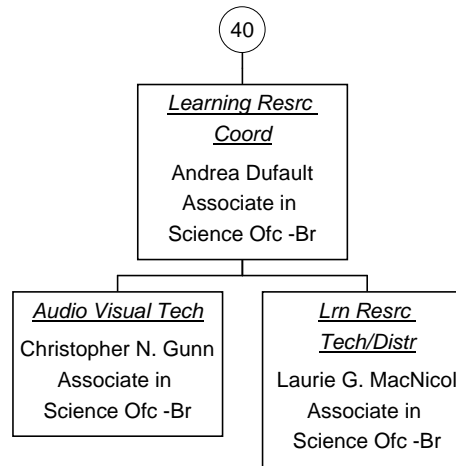

■ Vacant Position
■ Cabinet Position



ExDir, FLATE As of 11/02/2009

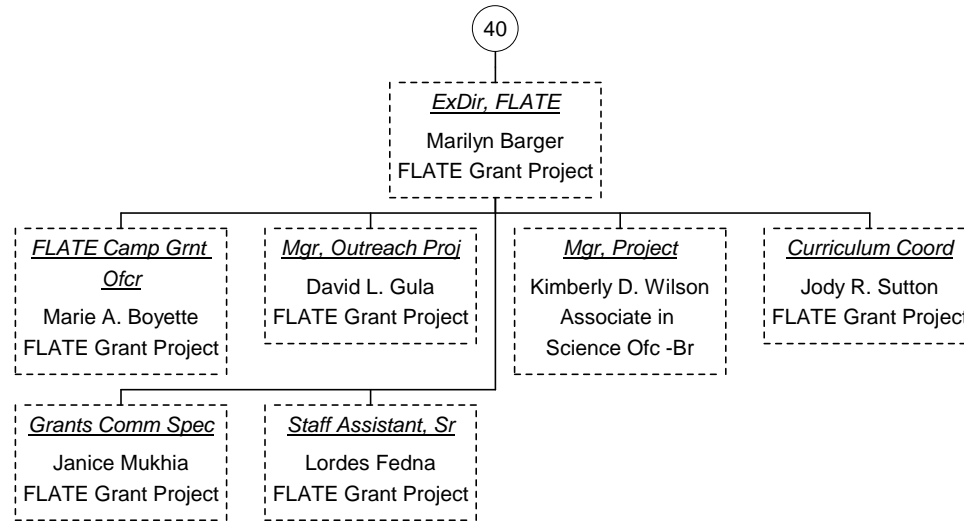

Vacant Position
 Cabinet Position



**Mgr, CASS Project As of
11/02/2009**

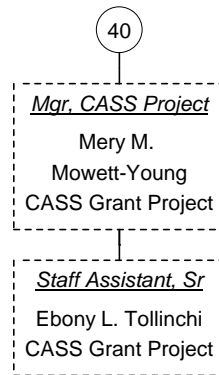

Vacant Position
Cabinet Position



**Dean, Student Svcs As of
11/02/2009**

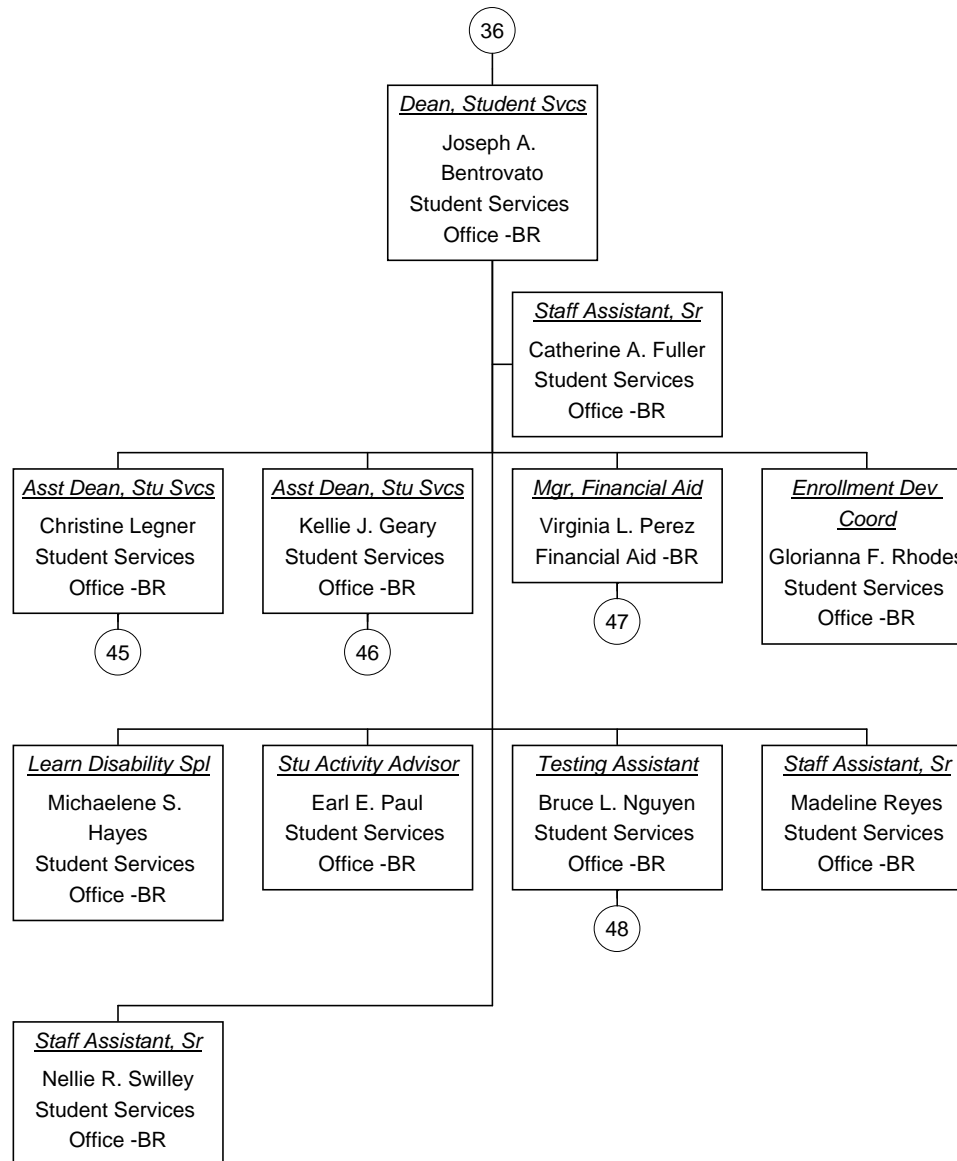

Vacant Position
 Cabinet Position



**Asst Dean, Stu Svcs As of
11/02/2009**

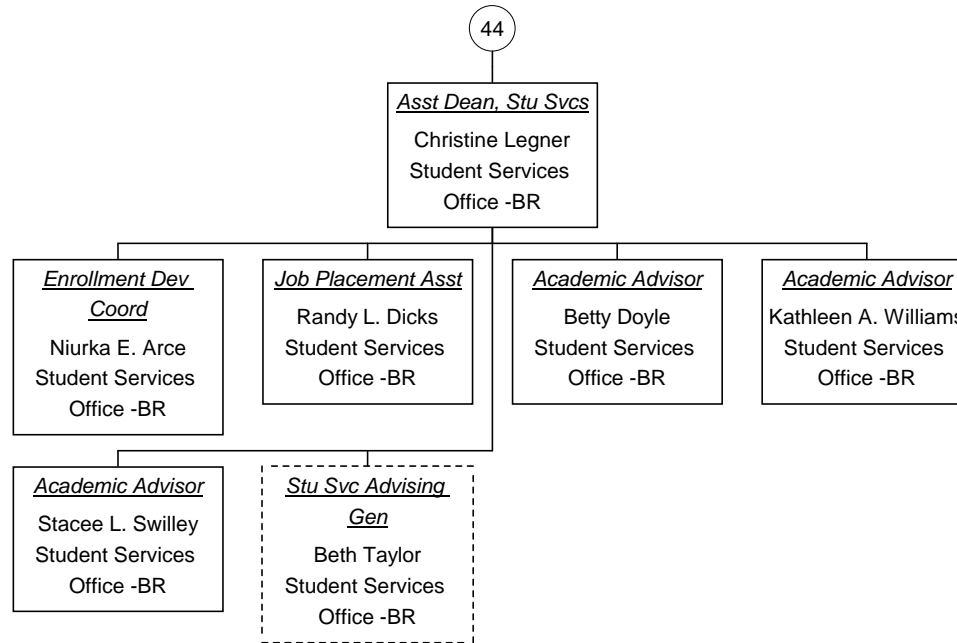

Vacant Position
 Cabinet Position



**Asst Dean, Stu Svcs As of
11/02/2009**

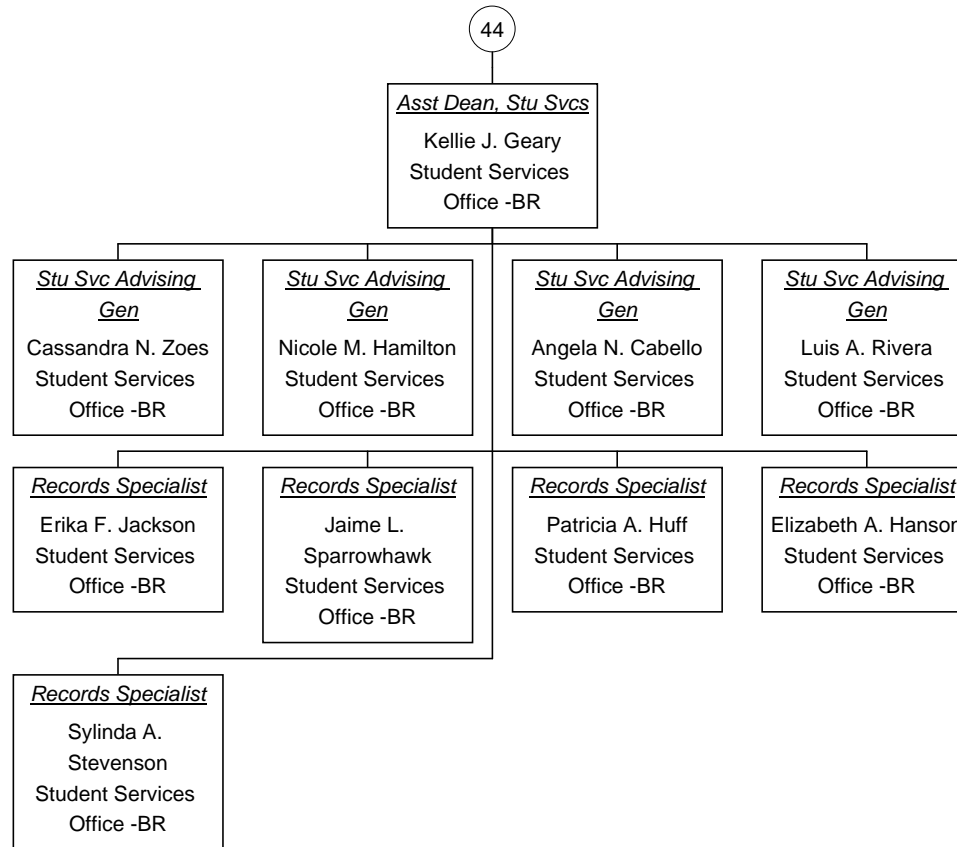

Vacant Position
 Cabinet Position



**Mgr, Financial Aid As of
11/02/2009**

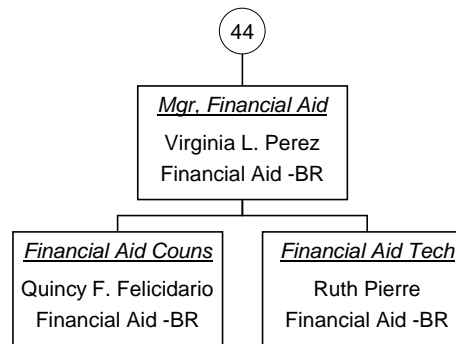

Vacant Position
Cabinet Position



Testing Assistant As of
11/02/2009

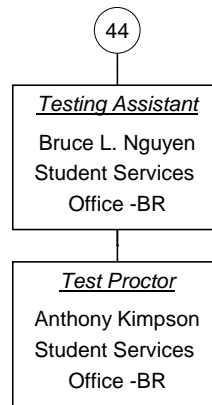

■ Vacant Position
■ Cabinet Position



Mgr, Facilities As of 11/02/2009

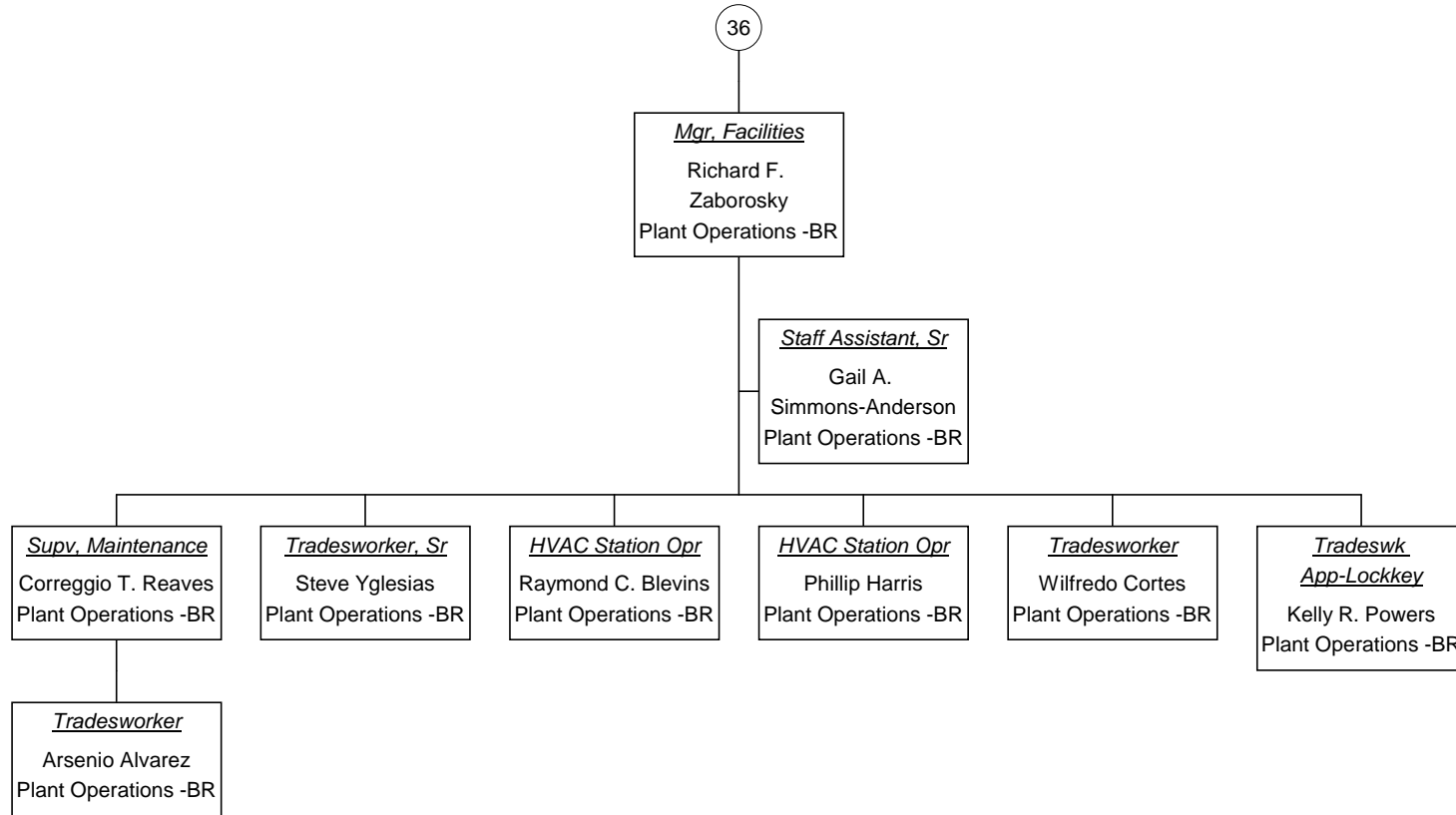

Vacant Position
 Cabinet Position



**Campus President, PC As of
11/02/2009**

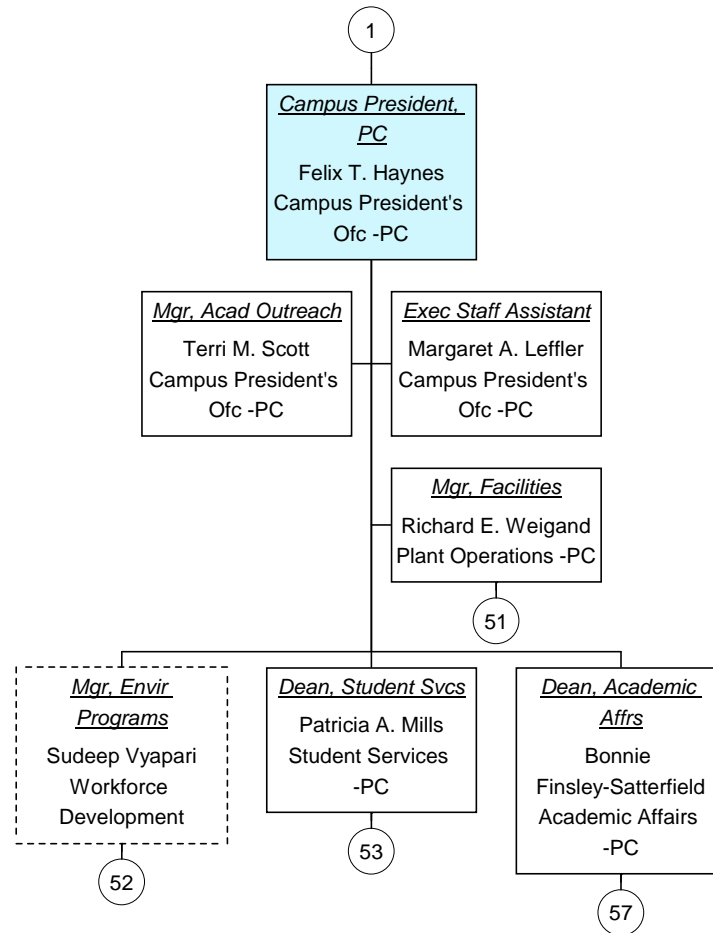

Vacant Position
 Cabinet Position



Mgr, Facilities As of 11/02/2009

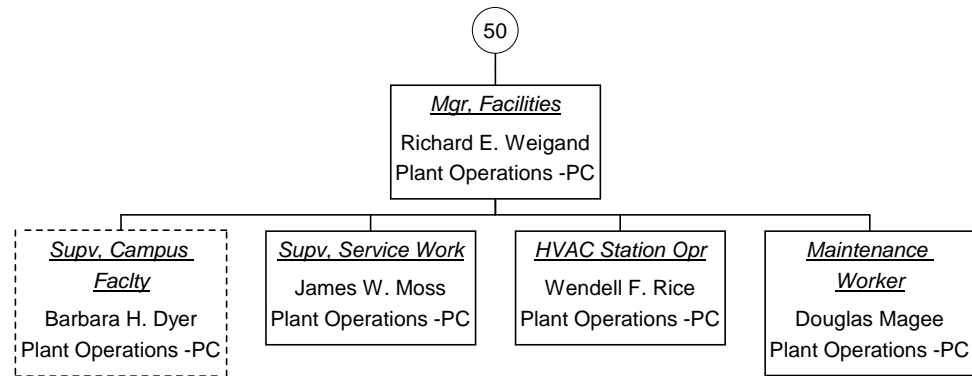

Vacant Position
Cabinet Position



**Mgr, Envir Programs As of
11/02/2009**

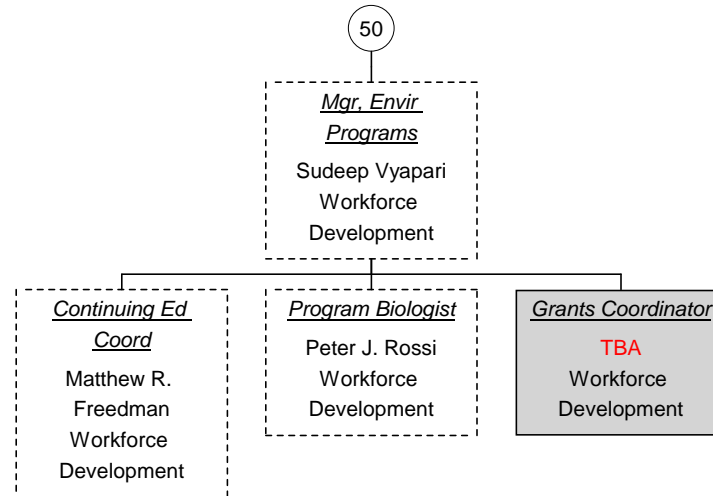

■ Vacant Position
■ Cabinet Position



**Dean, Student Svcs As of
11/02/2009**

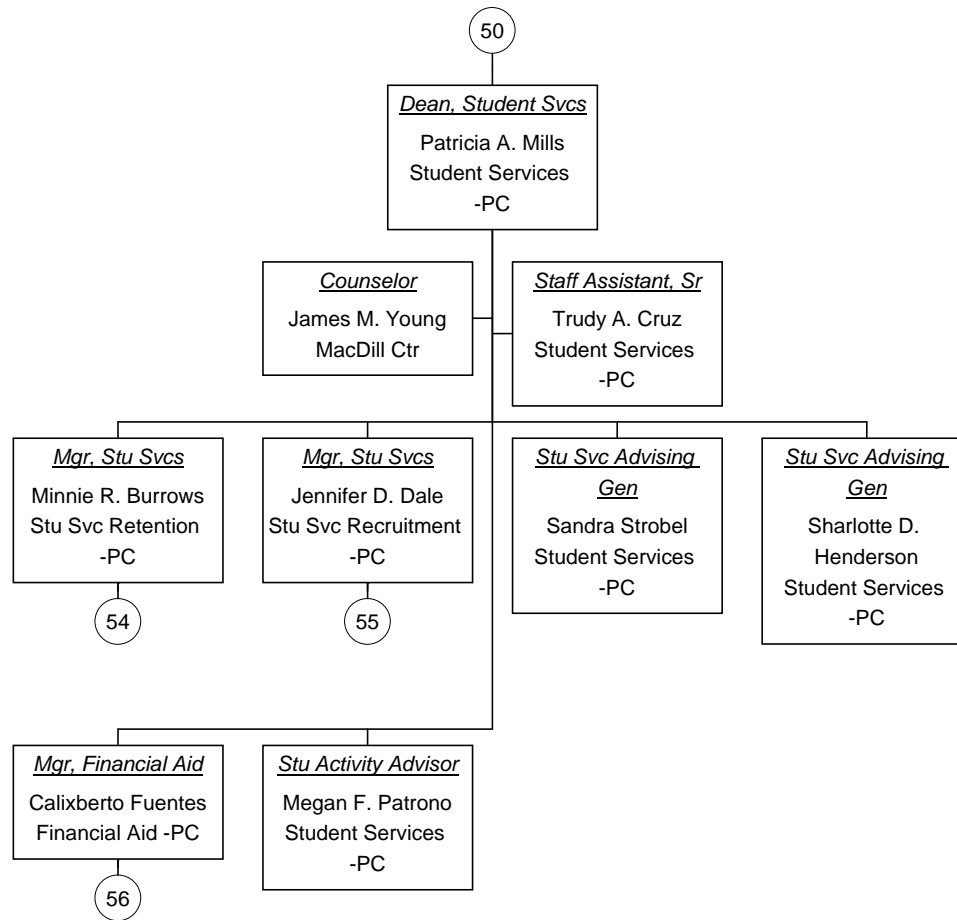

Vacant Position
 Cabinet Position



Mgr, Stu Svcs As of 11/02/2009

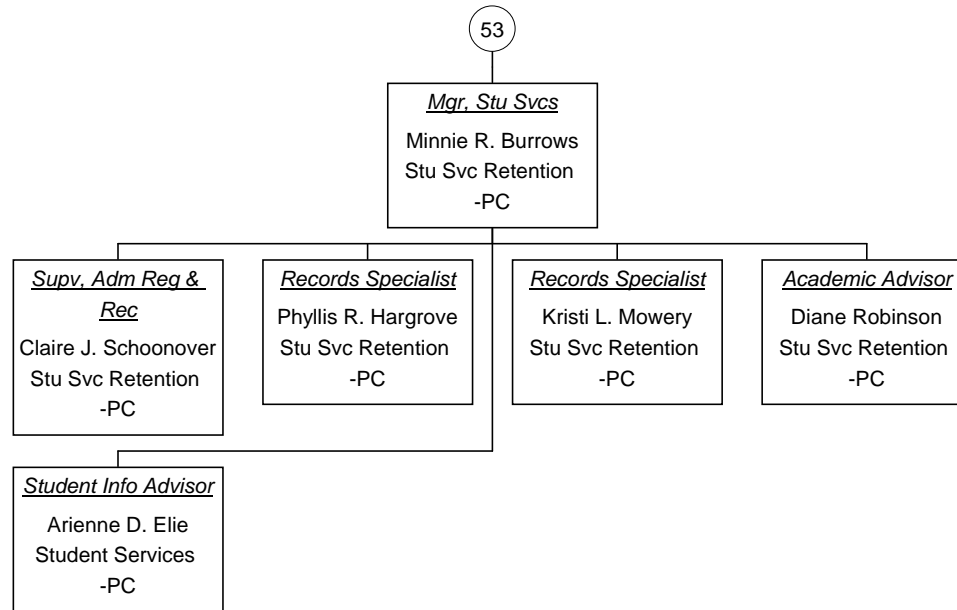

Vacant Position
Cabinet Position



Mgr, Stu Svcs As of 11/02/2009

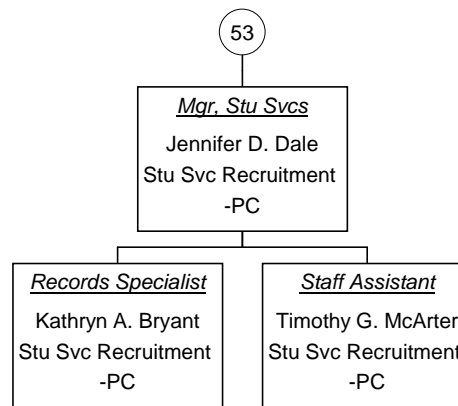

■ Vacant Position
■ Cabinet Position



**Mgr, Financial Aid As of
11/02/2009**

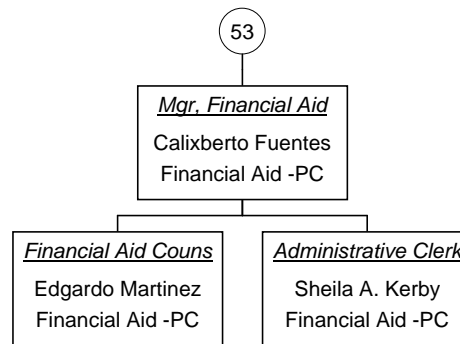

■ Vacant Position
■ Cabinet Position

Dean, Academic Affrs As of
11/02/2009

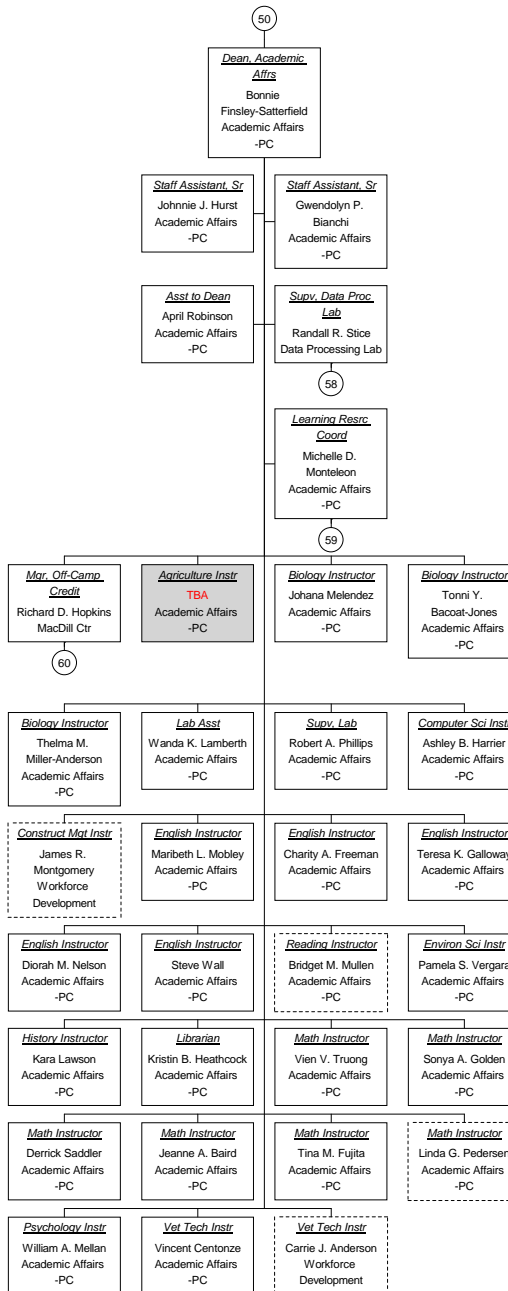

 Vacant Position
 Cabinet Position
 Dotted border = Temp Position



**Supv, Data Proc Lab As of
11/02/2009**

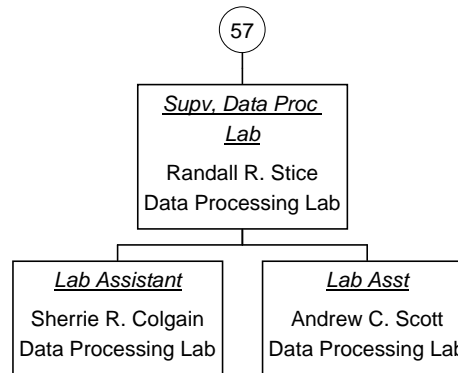

■ Vacant Position
■ Cabinet Position



Learning Resrc Coord As of
11/02/2009

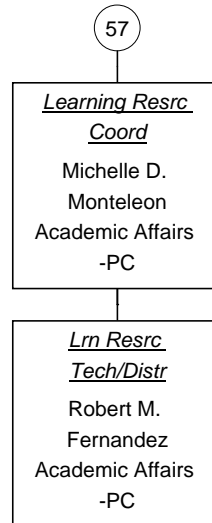

■ Vacant Position
■ Cabinet Position



**Mgr, Off-Camp Credit As of
11/02/2009**

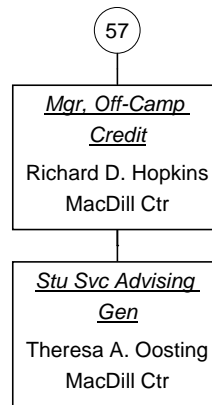

■ Vacant Position
■ Cabinet Position



Campus President, SS As of 11/02/2009

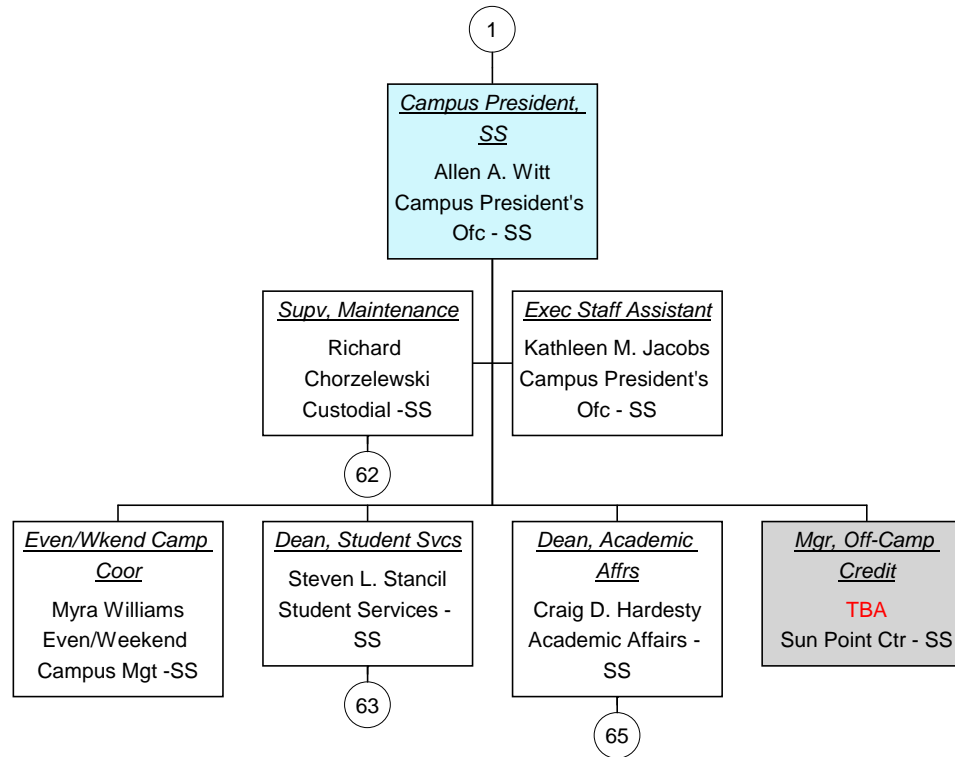

Vacant Position
 Cabinet Position



**Supv, Maintenance As of
11/02/2009**

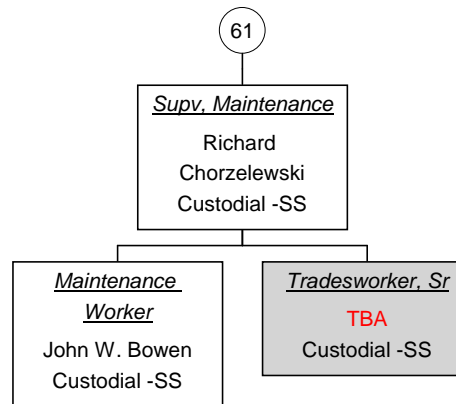

■ Vacant Position
■ Cabinet Position



**Dean, Student Svcs As of
11/02/2009**

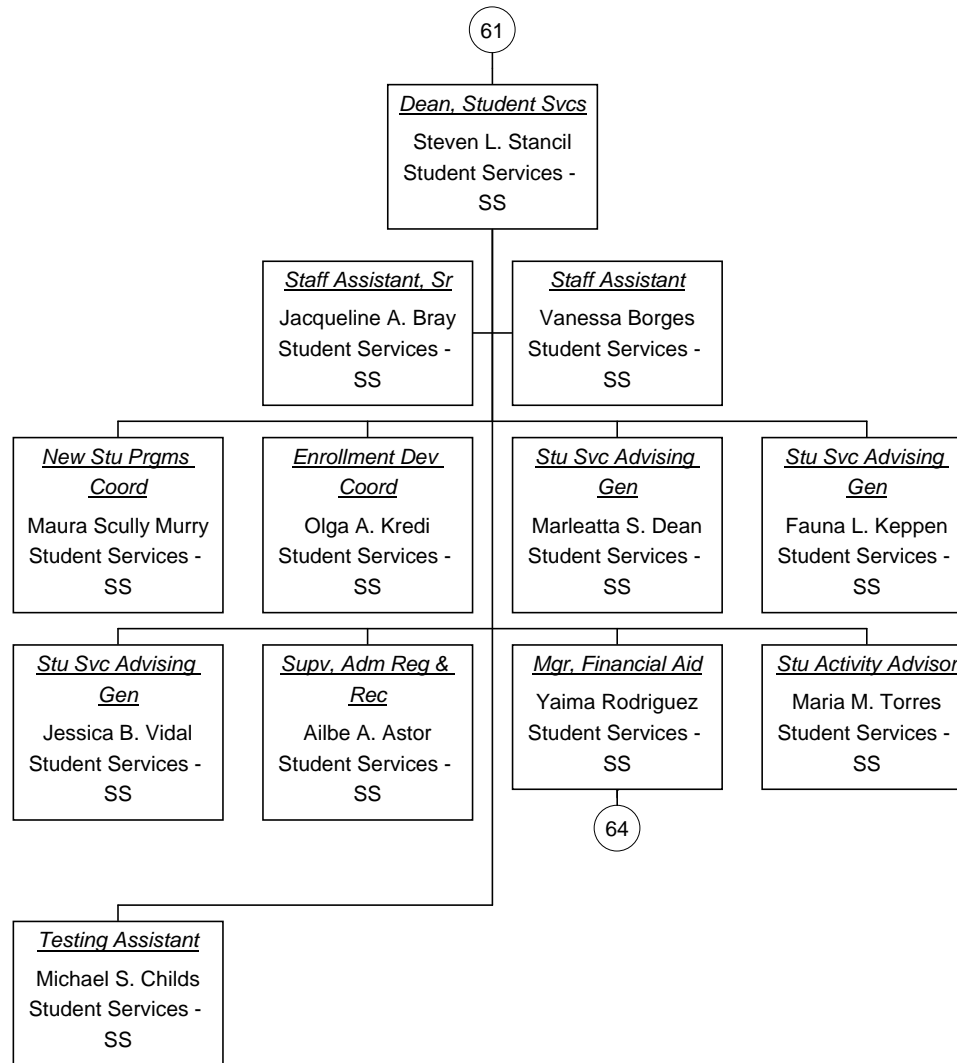

Vacant Position
 Cabinet Position



**Mgr, Financial Aid As of
11/02/2009**

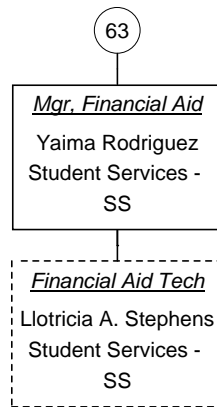

■ Vacant Position
■ Cabinet Position



Dean, Academic Affrs As of
11/02/2009

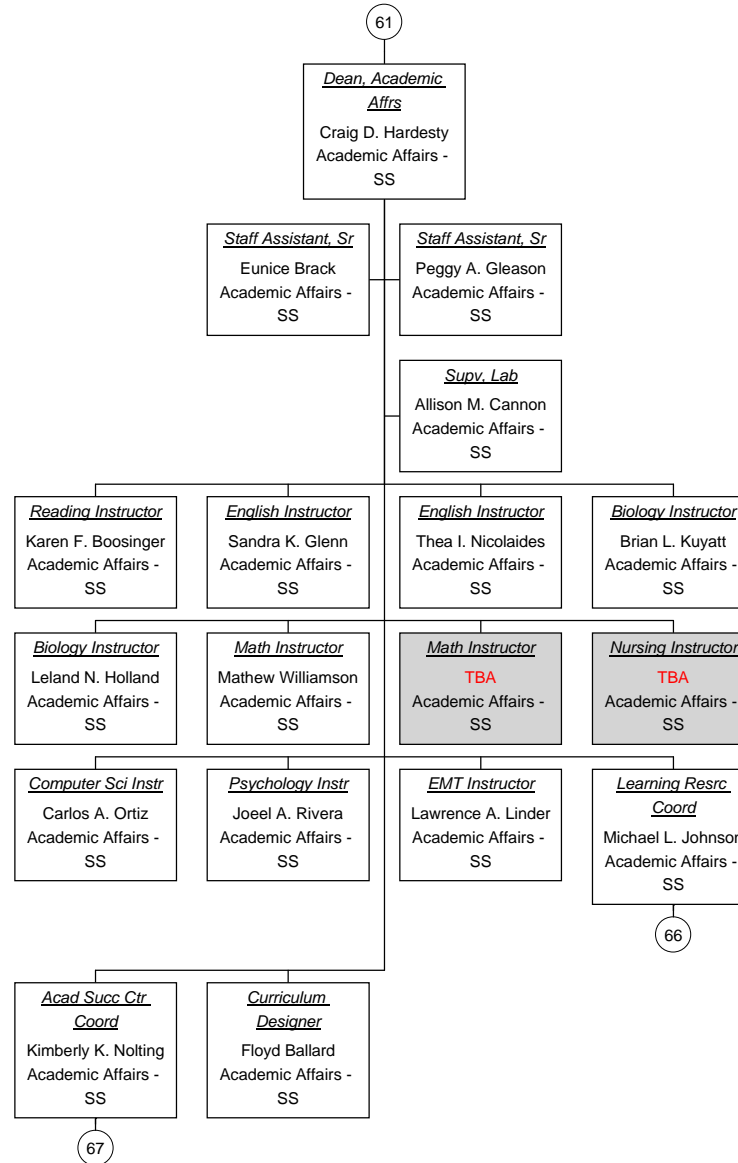

Vacant Position
 Cabinet Position



Learning Resrc Coord As of
11/02/2009

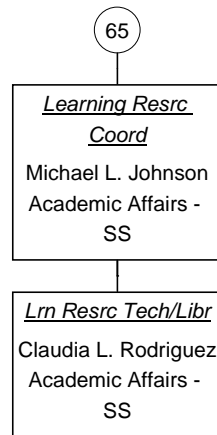

■ Vacant Position
■ Cabinet Position



**Acad Succ Ctr Coord As of
11/02/2009**

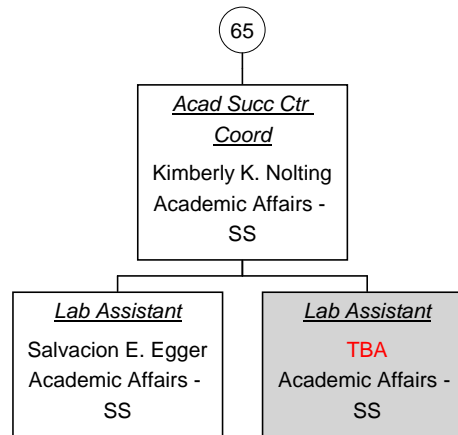

■ Vacant Position
■ Cabinet Position



**VP, Stu Svc Enr Mgt As of
11/02/2009**

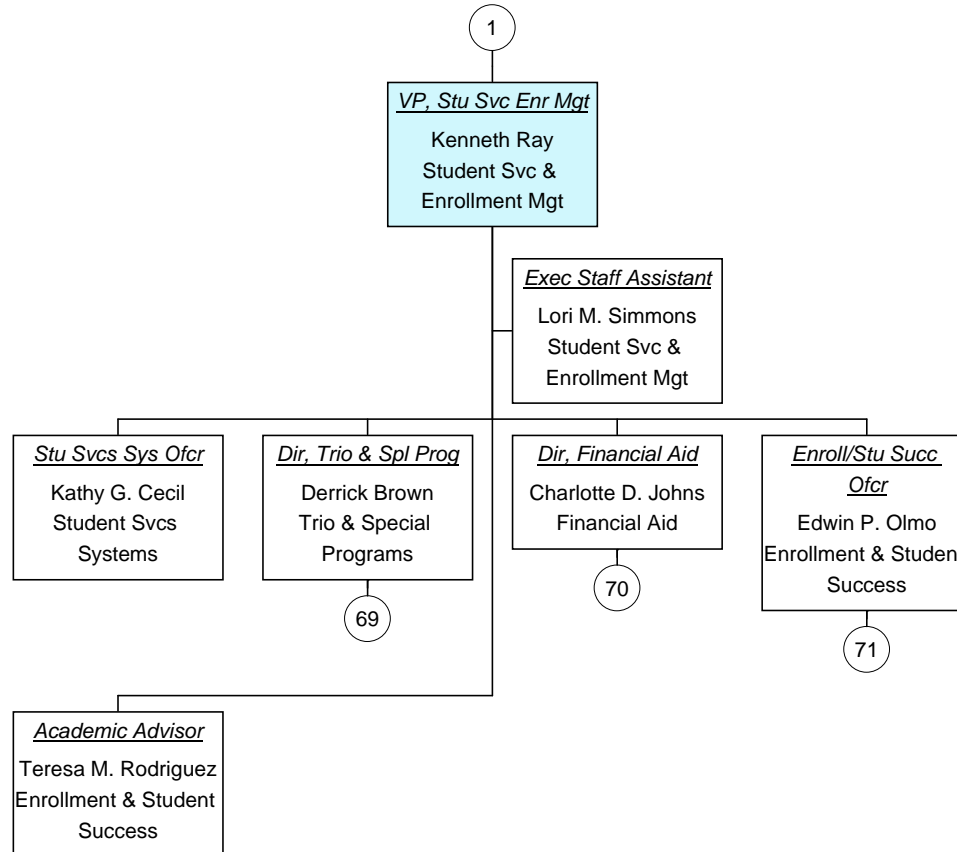

Vacant Position
 Cabinet Position



Dir, Trio & Spl Prog As of
11/02/2009

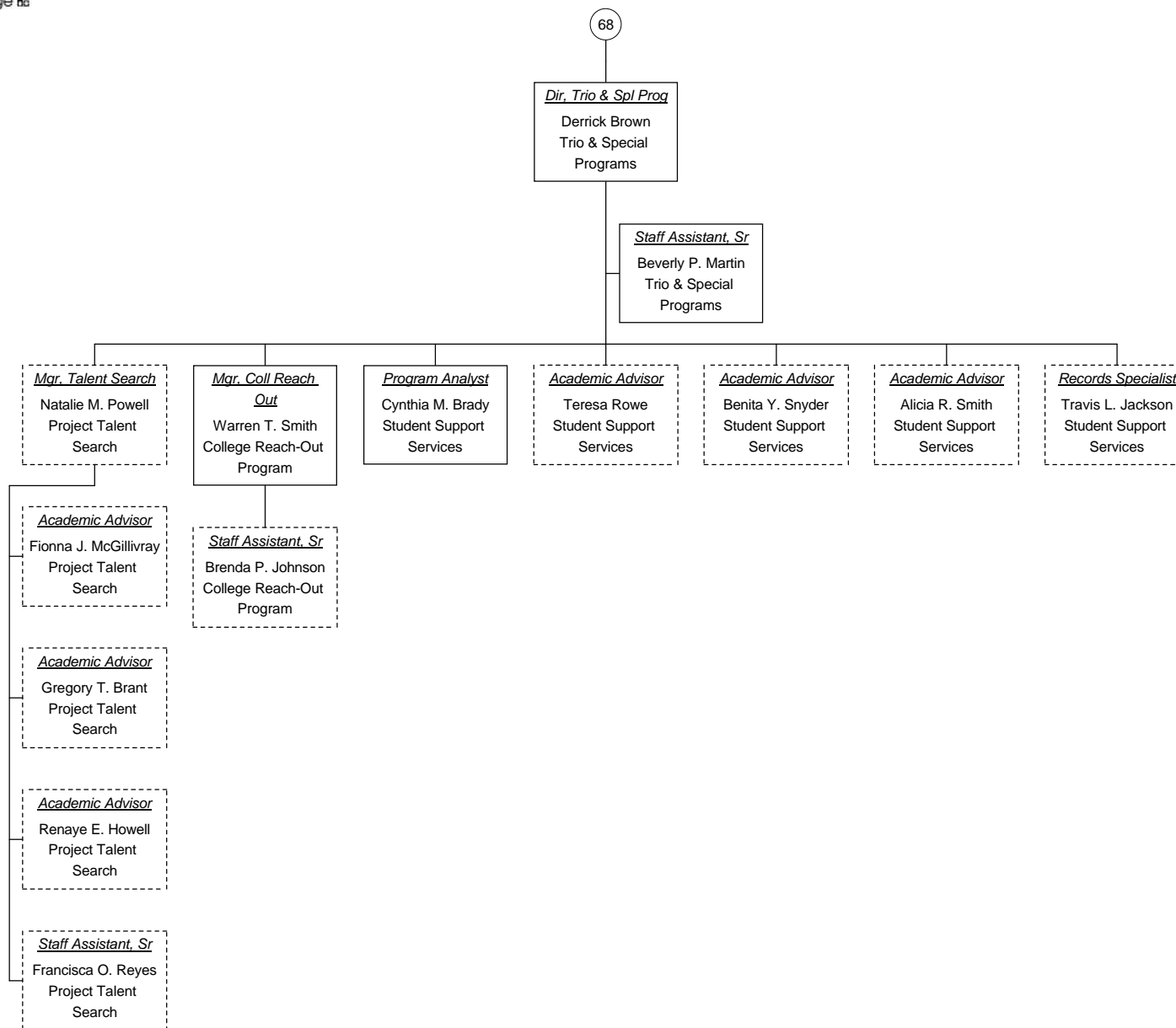

Vacant Position
 Cabinet Position



**Dir, Financial Aid As of
11/02/2009**

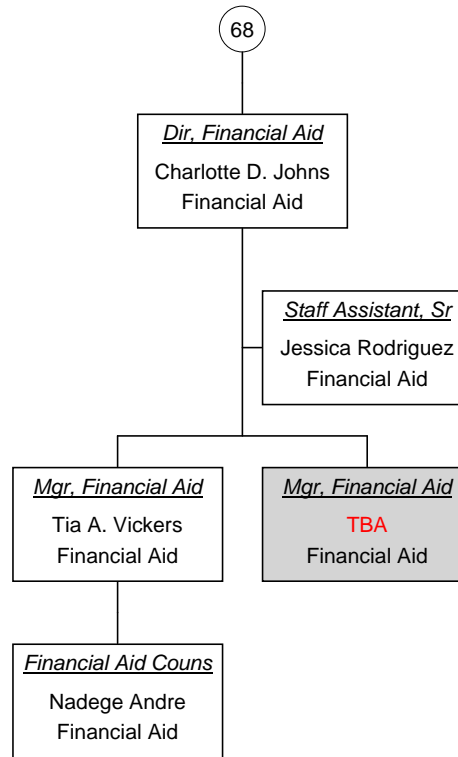

■ Vacant Position
■ Cabinet Position



**Enroll/Stu Succ Ofcr As of
11/02/2009**

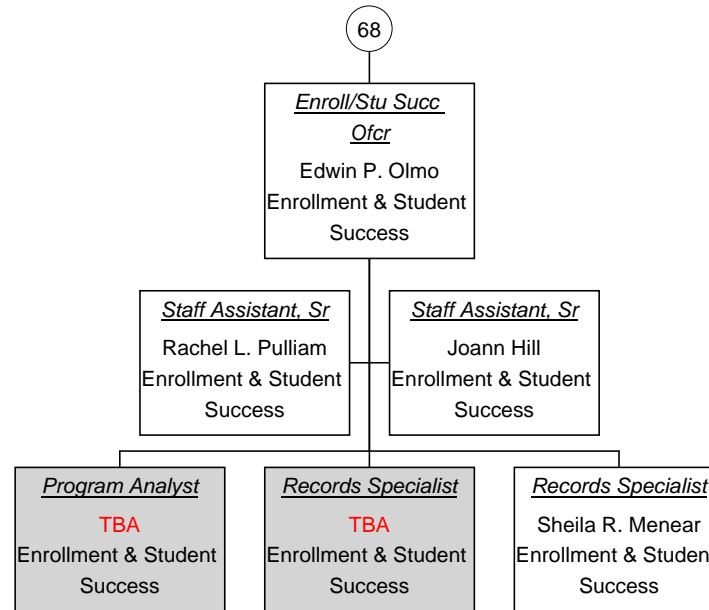

Vacant Position
 Cabinet Position



VP, Acad Affrs As of 11/02/2009

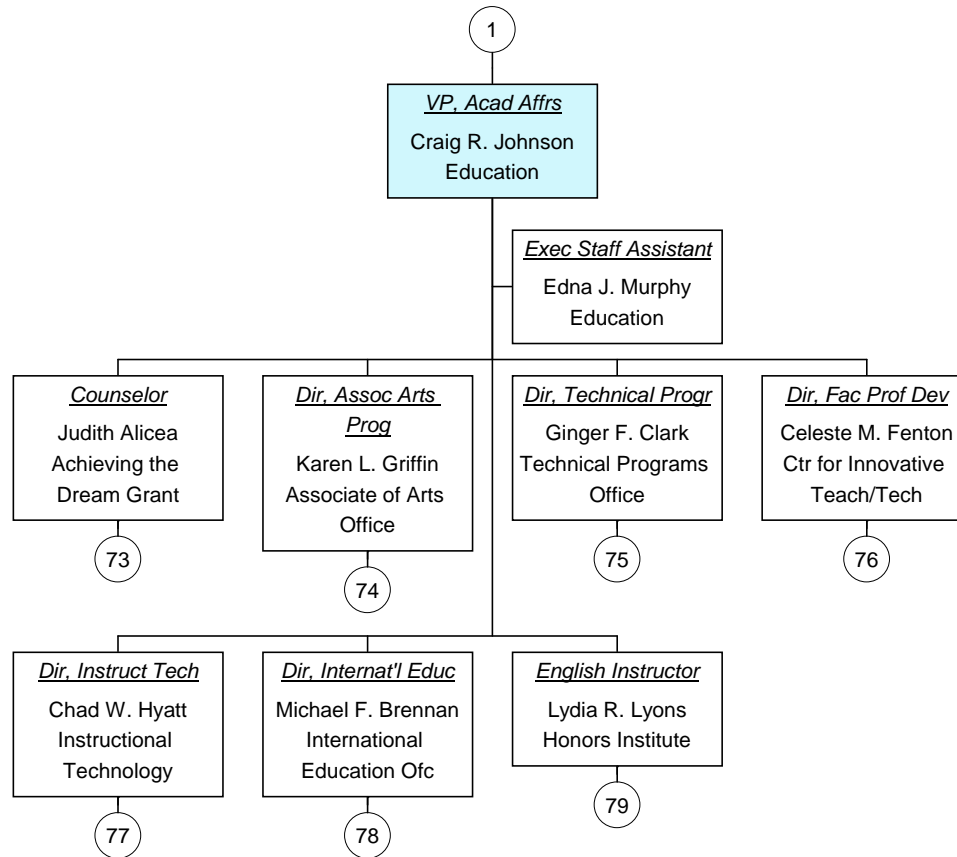

Vacant Position
 Cabinet Position



Counselor As of 11/02/2009

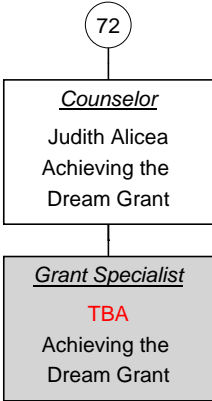

Vacant Position
 Cabinet Position

**Dir, Assoc Arts Prog As of
11/02/2009**

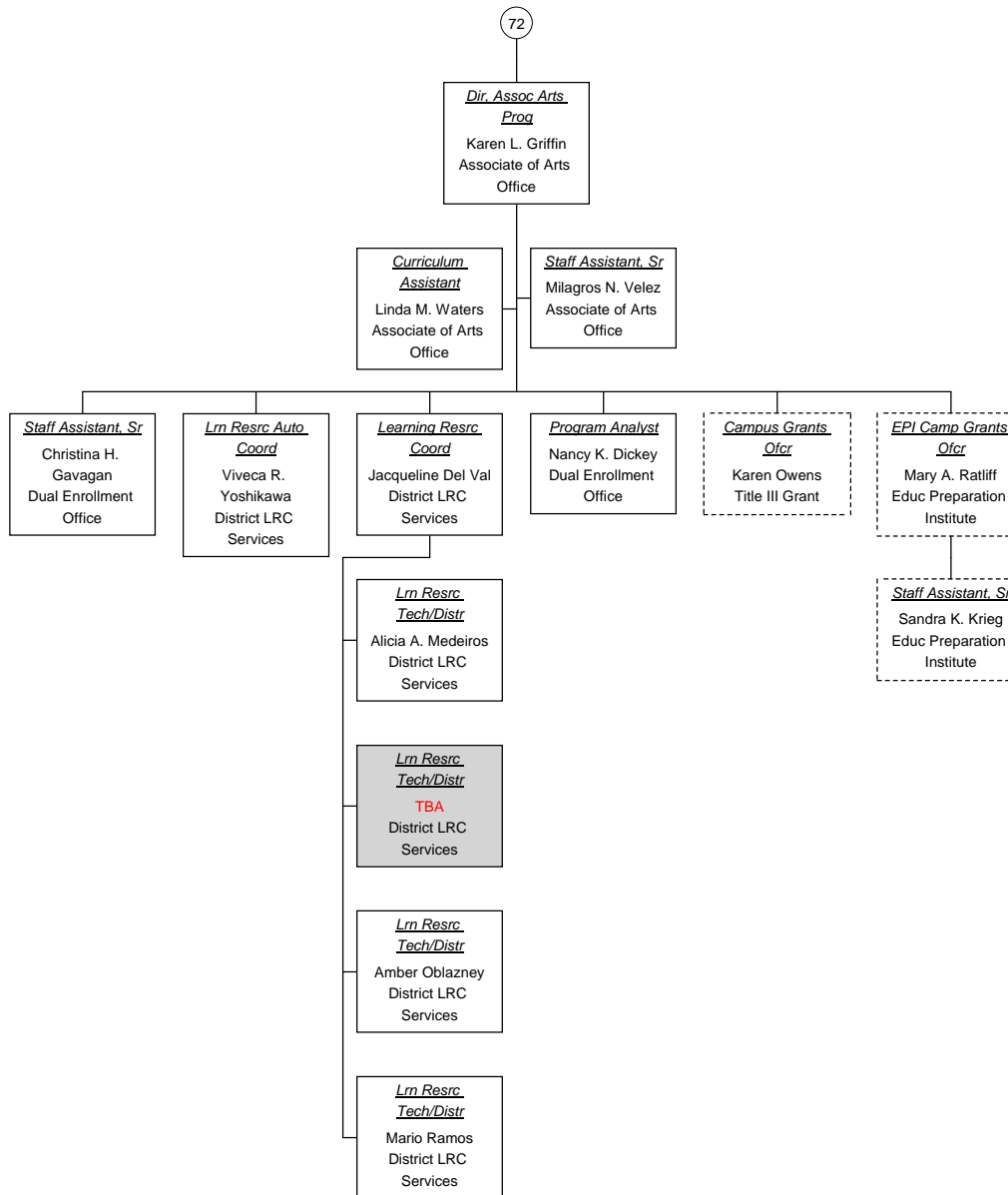

Vacant Position
Cabinet Position

**Dir, Technical Progr As of
11/02/2009**

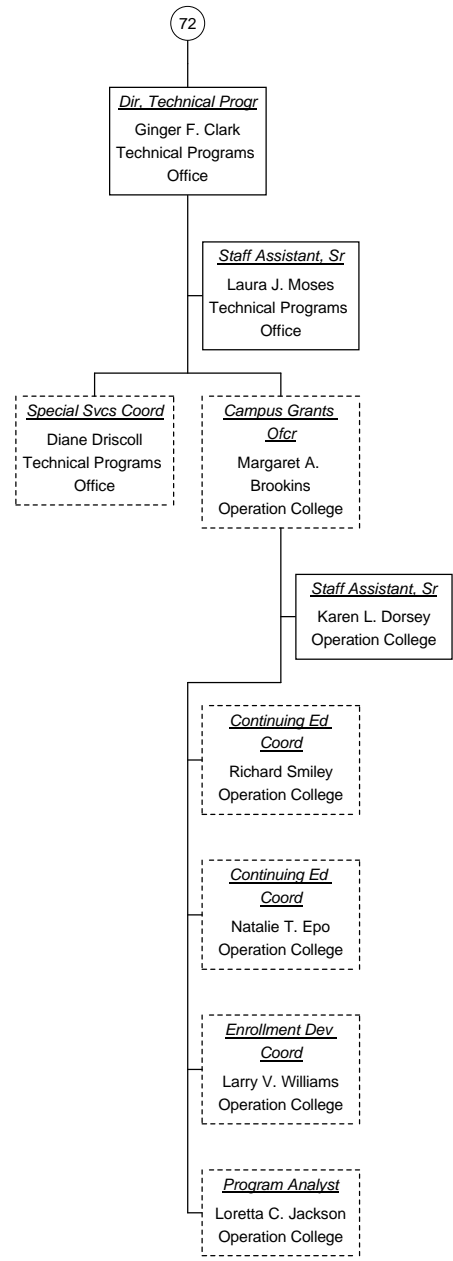

Vacant Position
 Cabinet Position



**Dir, Fac Prof Dev As of
11/02/2009**

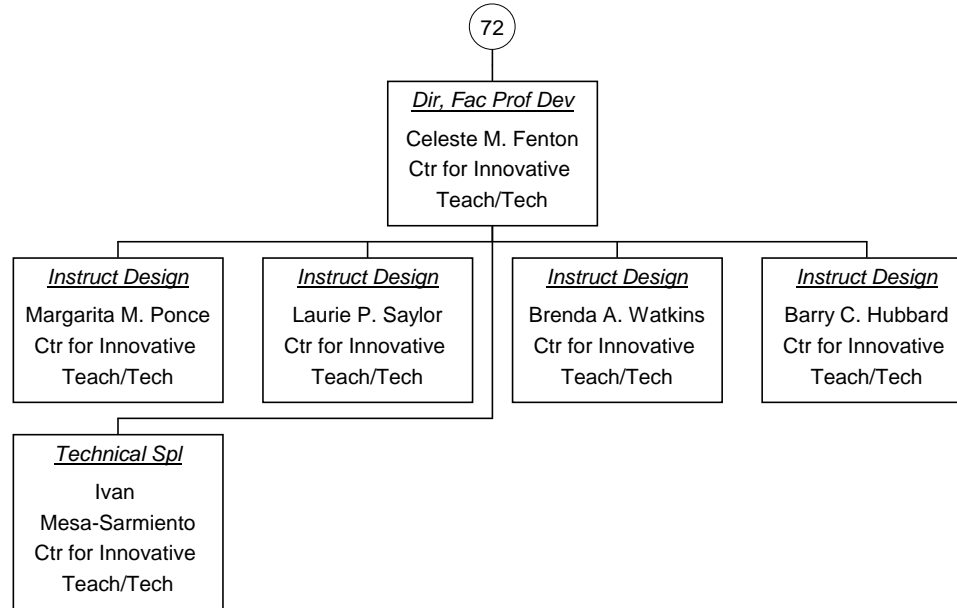

Vacant Position
Cabinet Position



Dir, Instruct Tech As of
11/02/2009

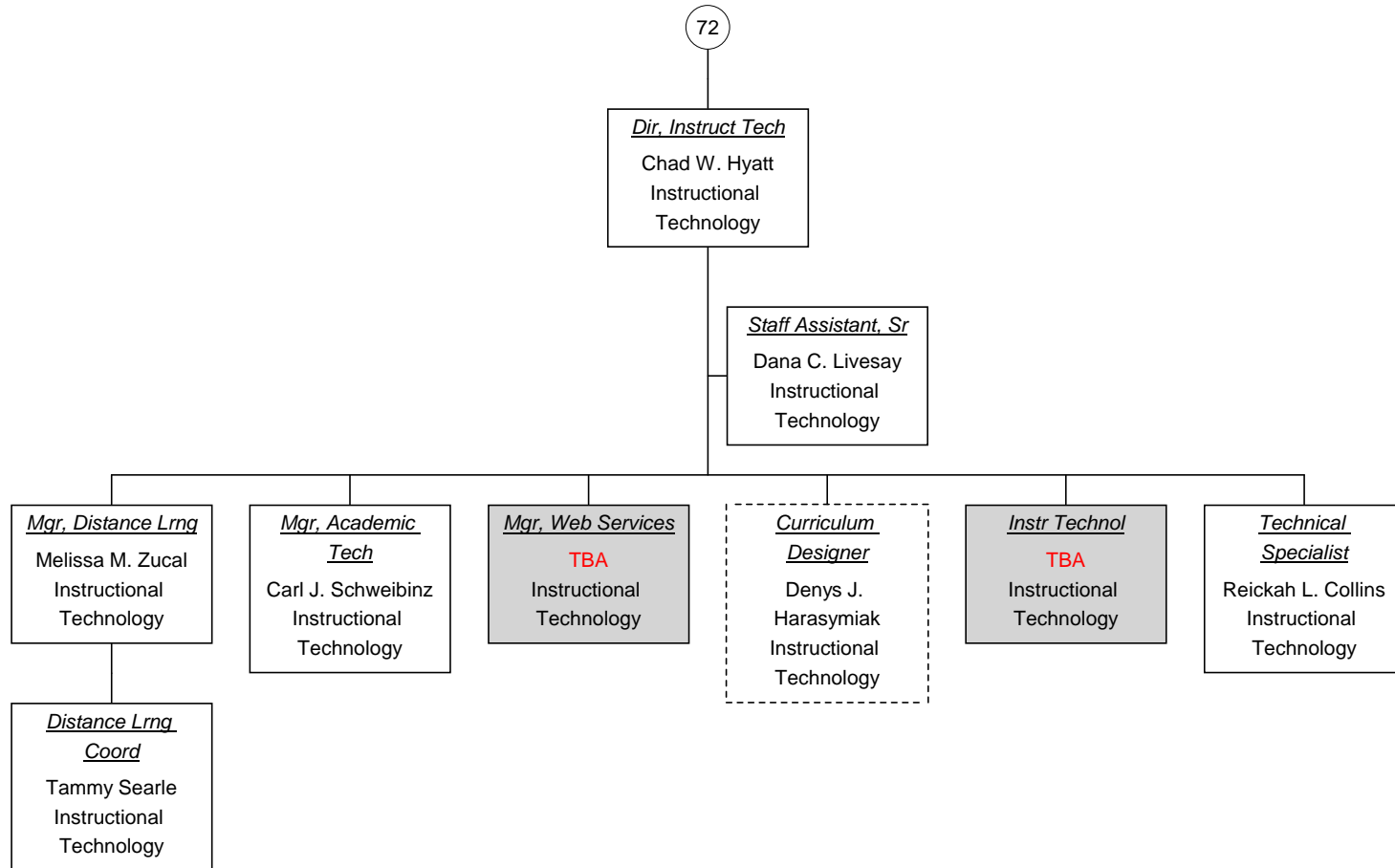

Vacant Position
 Cabinet Position



Dir, Internat'l Educ As of 11/02/2009

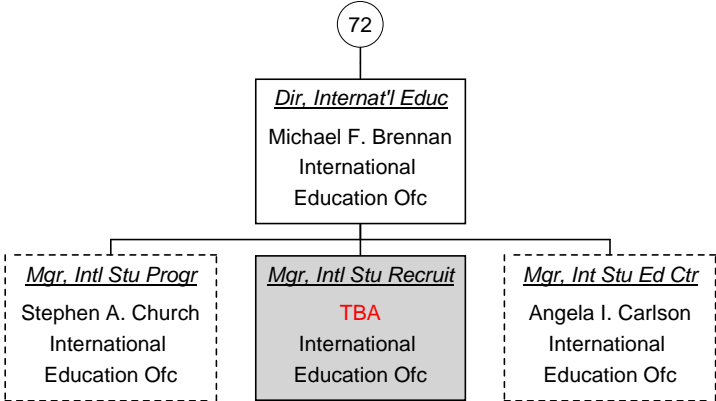

Vacant Position
 Cabinet Position



**English Instructor As of
11/02/2009**

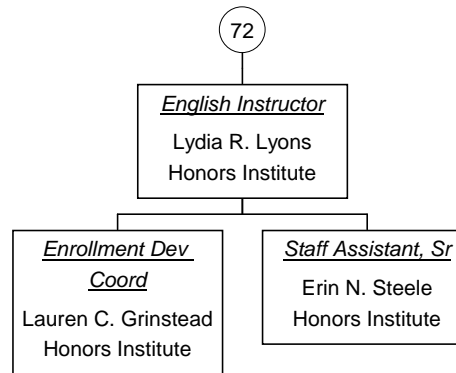

Vacant Position
Cabinet Position



**VP, Admin / CFO As of
11/02/2009**

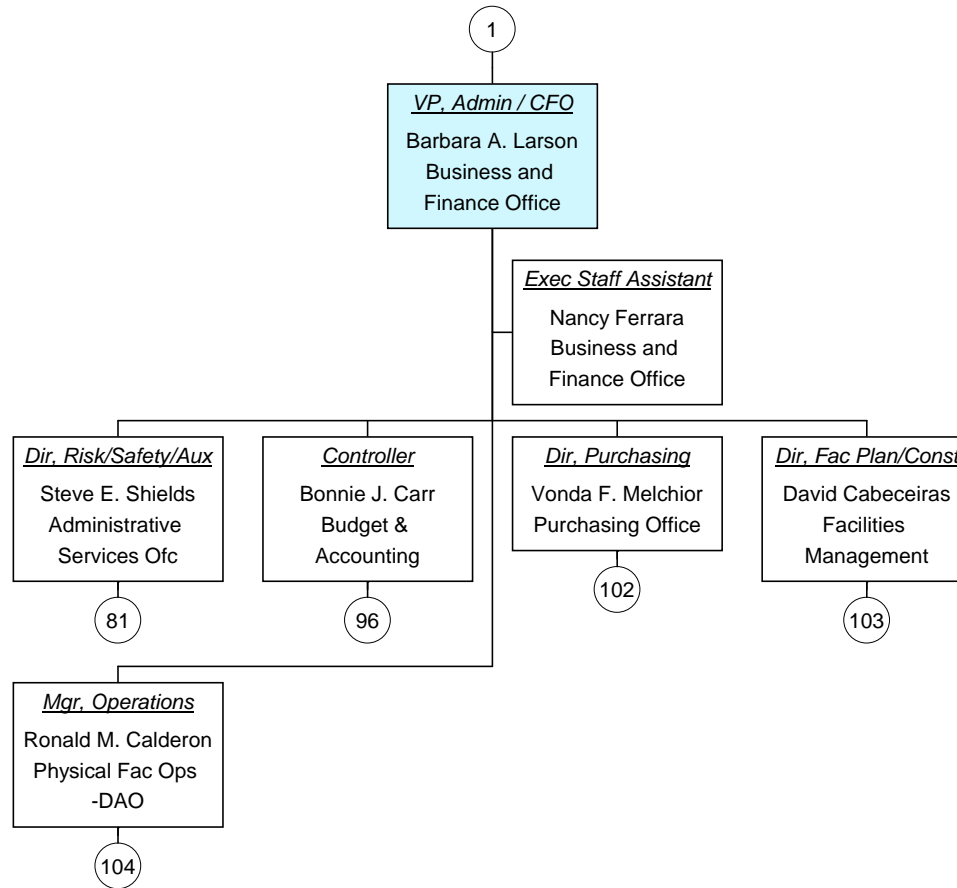

Vacant Position
 Cabinet Position



**Dir, Risk/Safety/Aux As of
11/02/2009**

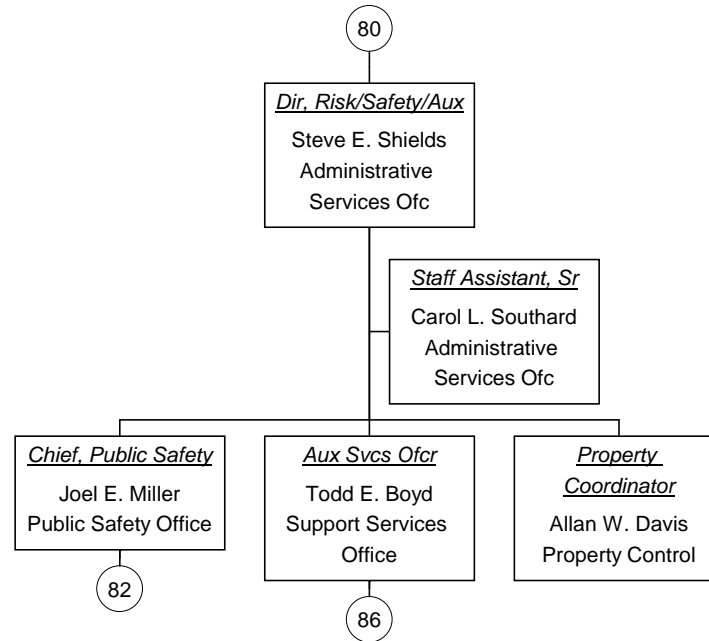

■ Vacant Position
■ Cabinet Position



Chief, Public Safety As of 11/02/2009

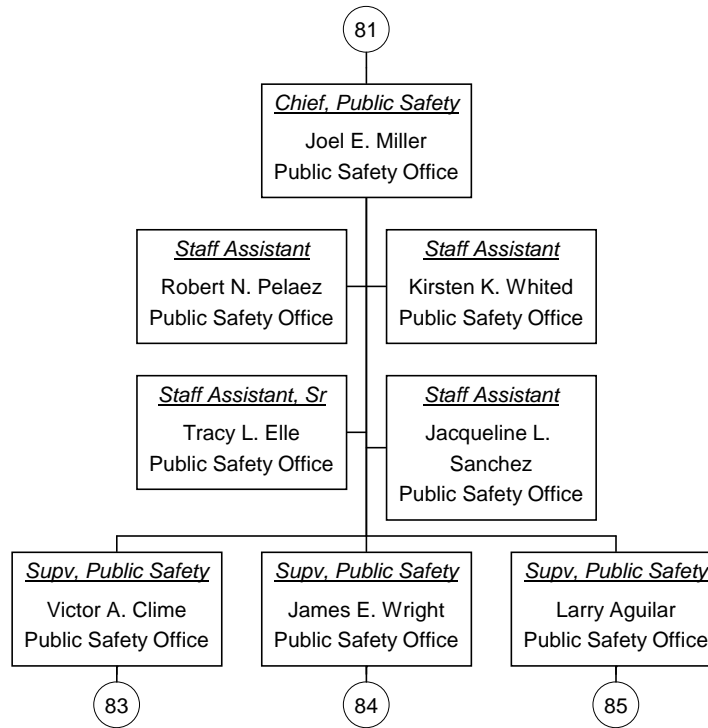

Vacant Position
Cabinet Position



**Supv, Public Safety As of
11/02/2009**

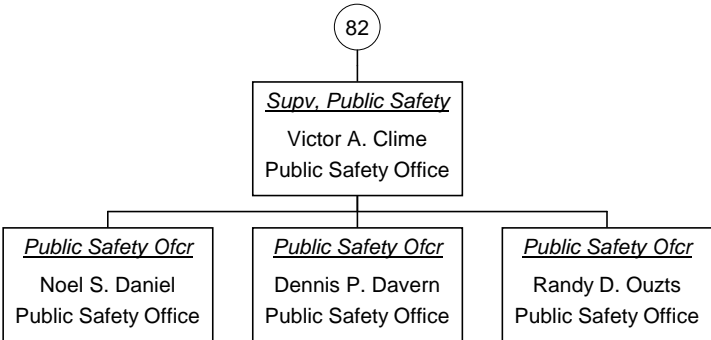

Vacant Position
 Cabinet Position



**Supv, Public Safety As of
11/02/2009**

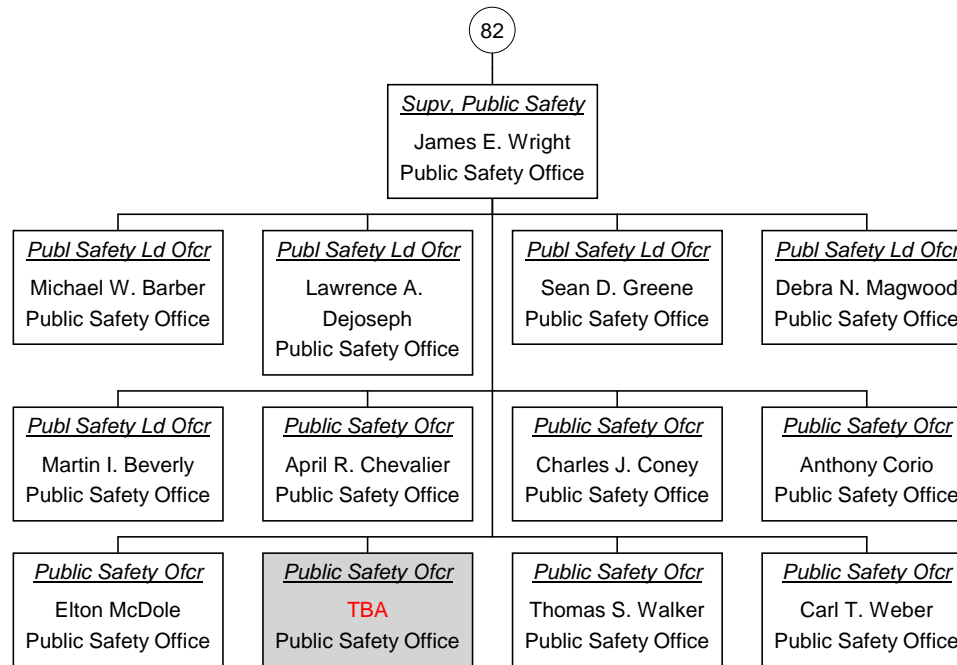

Vacant Position
 Cabinet Position



**Supv, Public Safety As of
11/02/2009**

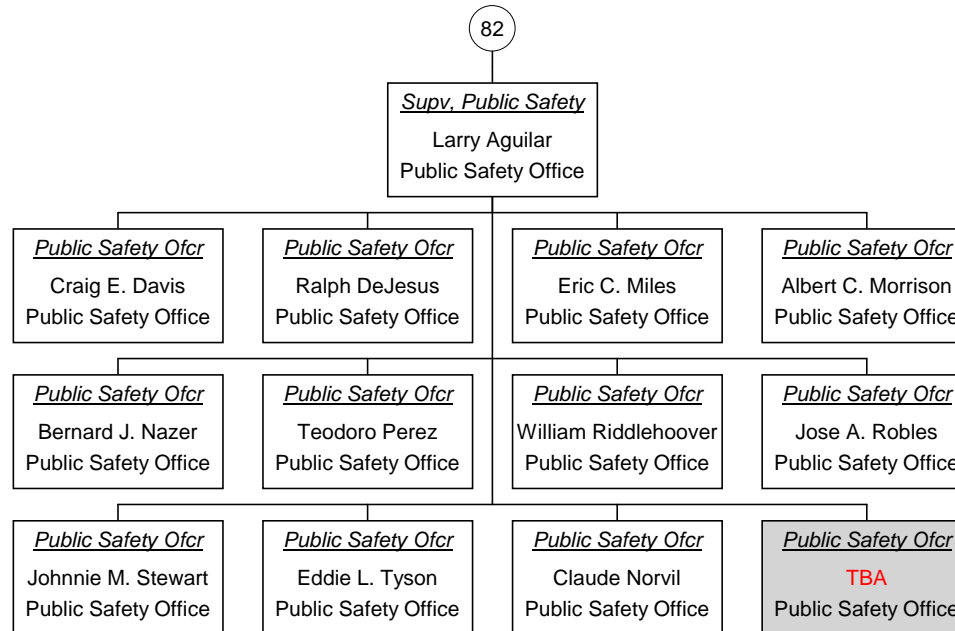

Vacant Position
 Cabinet Position



Aux Svcs Ofcr As of 11/02/2009

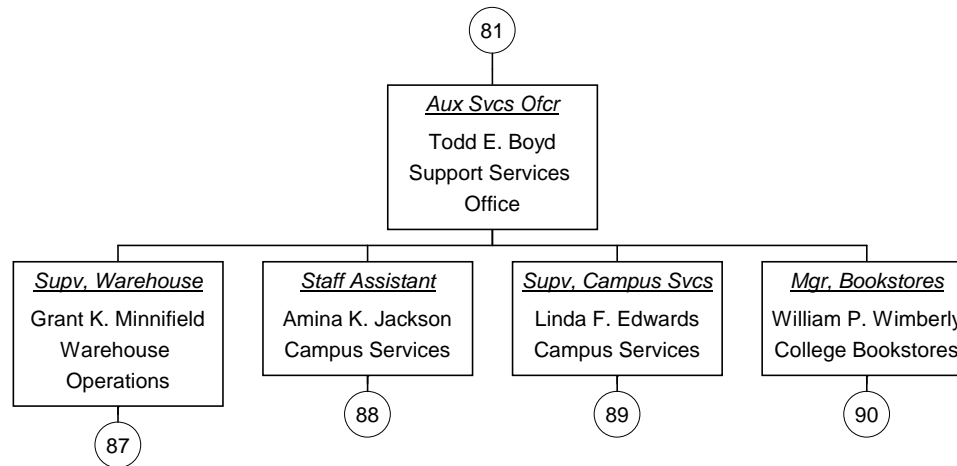

Vacant Position
Cabinet Position



**Supv, Warehouse As of
11/02/2009**

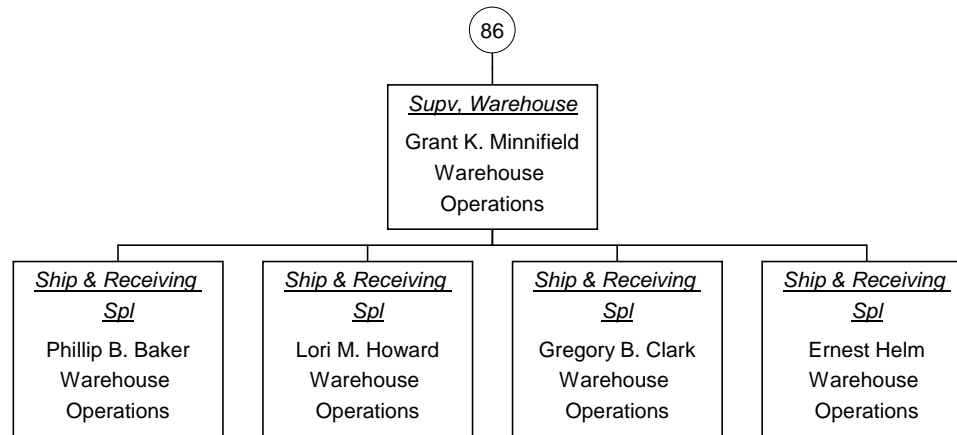

■ Vacant Position
■ Cabinet Position



Staff Assistant As of 11/02/2009

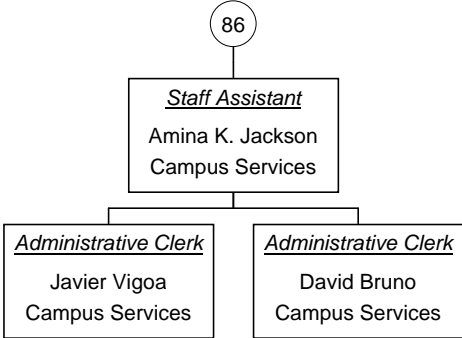

Vacant Position
 Cabinet Position



**Supv, Campus Svcs As of
11/02/2009**

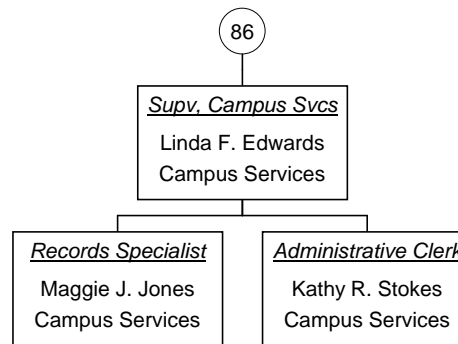

■ Vacant Position
■ Cabinet Position



**Mgr, Bookstores As of
11/02/2009**

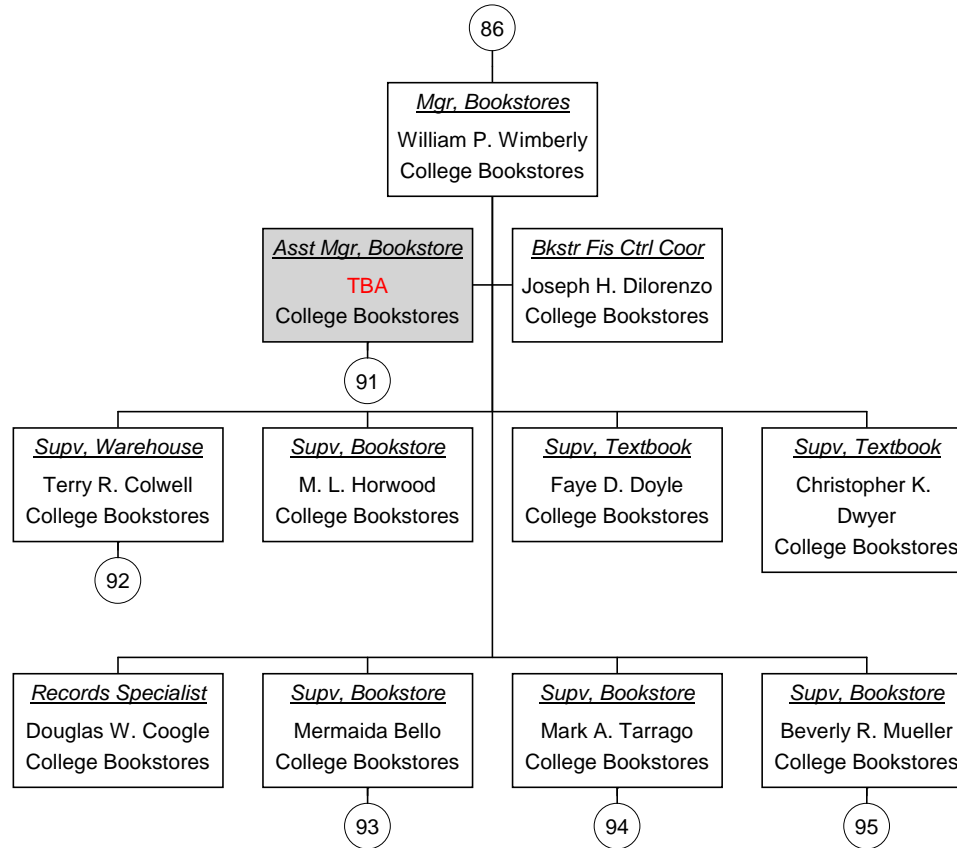

Vacant Position
 Cabinet Position



**Asst Mgr, Bookstore As of
11/02/2009**

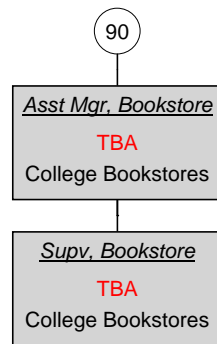

■ Vacant Position
■ Cabinet Position



**Supv, Warehouse As of
11/02/2009**

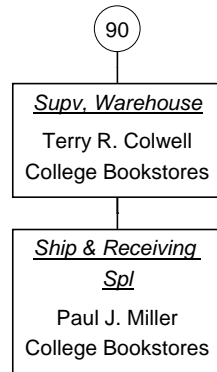

■ Vacant Position
■ Cabinet Position



**Supv, Bookstore As of
11/02/2009**

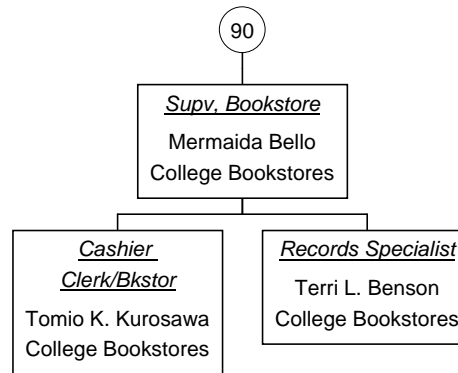

■ Vacant Position
■ Cabinet Position



**Supv, Bookstore As of
11/02/2009**

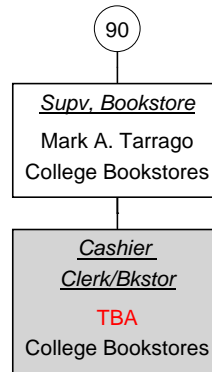

■ Vacant Position
■ Cabinet Position



**Supv, Bookstore As of
11/02/2009**

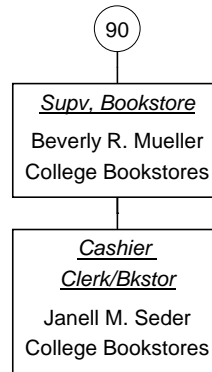

■ Vacant Position
■ Cabinet Position



Controller As of 11/02/2009

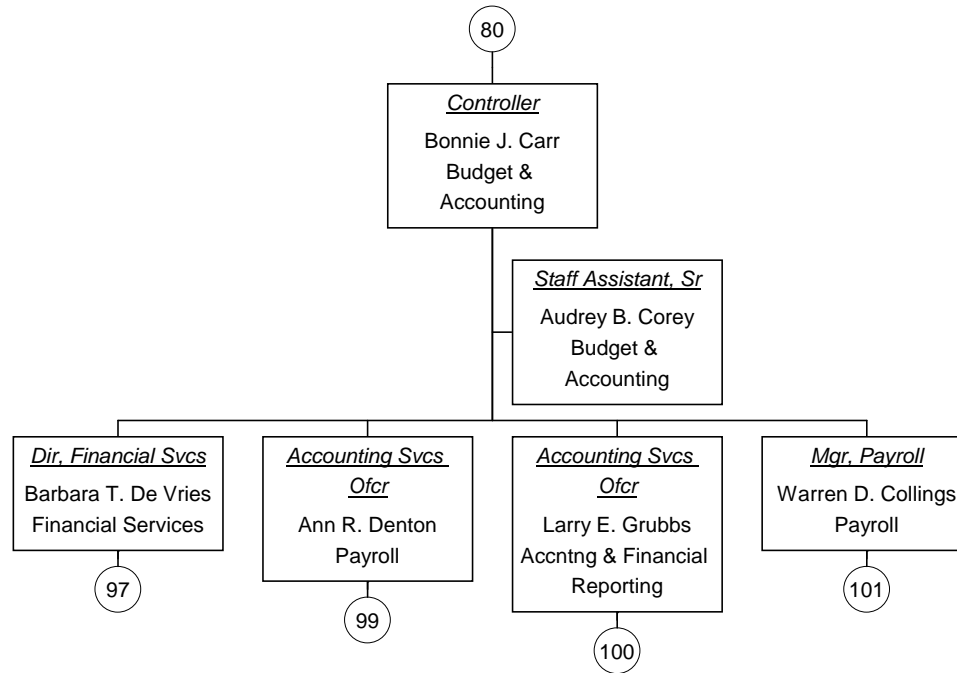

Vacant Position
Cabinet Position



**Dir, Financial Svcs As of
11/02/2009**

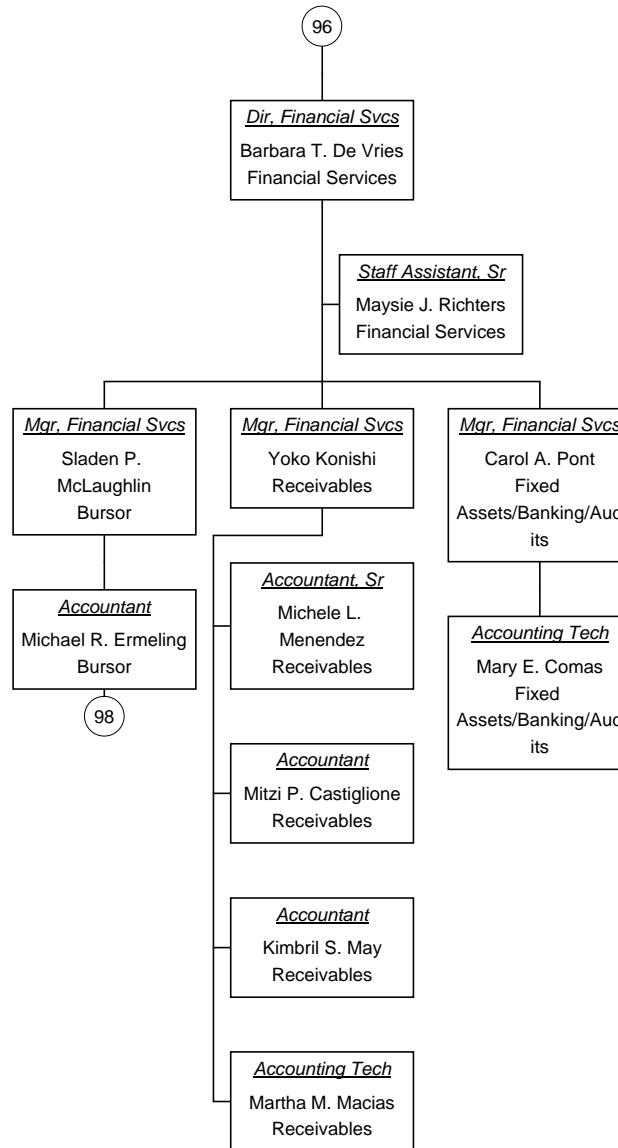

Vacant Position
 Cabinet Position

Accountant As of 11/02/2009

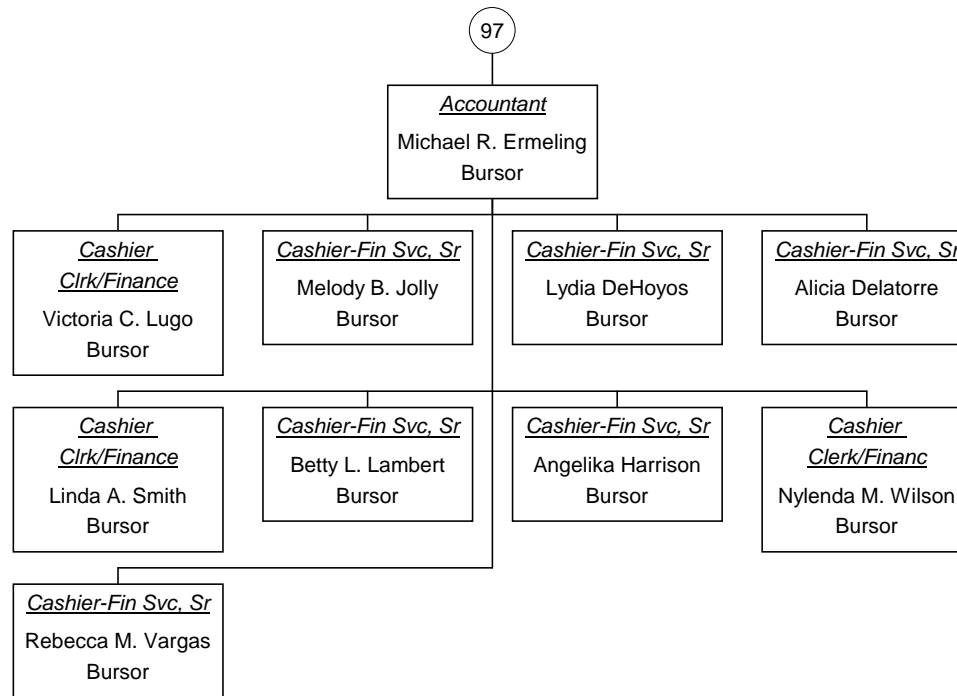

Vacant Position
 Cabinet Position



**Accounting Svcs Ofcr As of
11/02/2009**

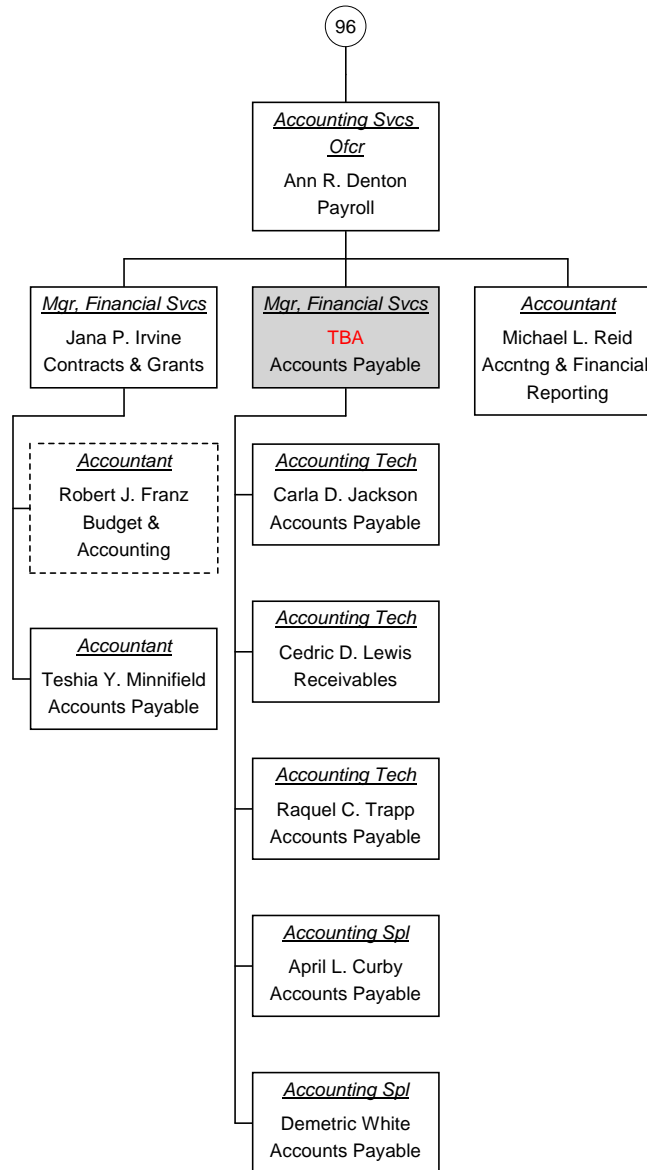

Vacant Position
 Cabinet Position

**Accounting Svcs Ofcr As of
11/02/2009**

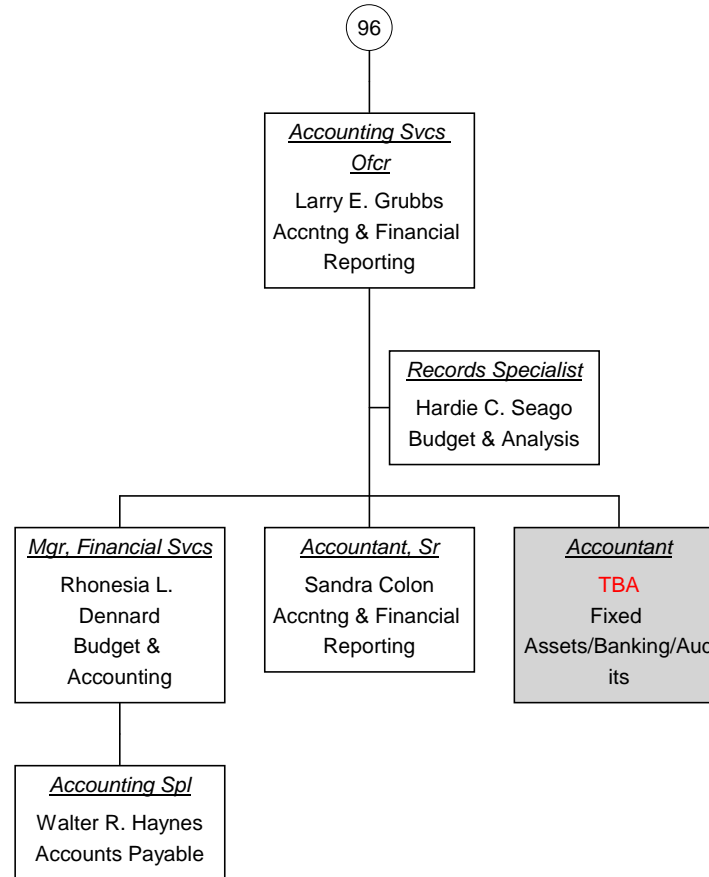

Vacant Position
 Cabinet Position



Mgr, Payroll As of 11/02/2009

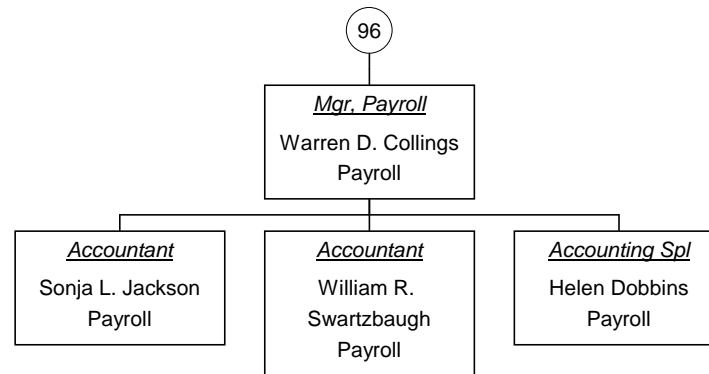

■ Vacant Position
■ Cabinet Position



**Dir, Purchasing As of
11/02/2009**

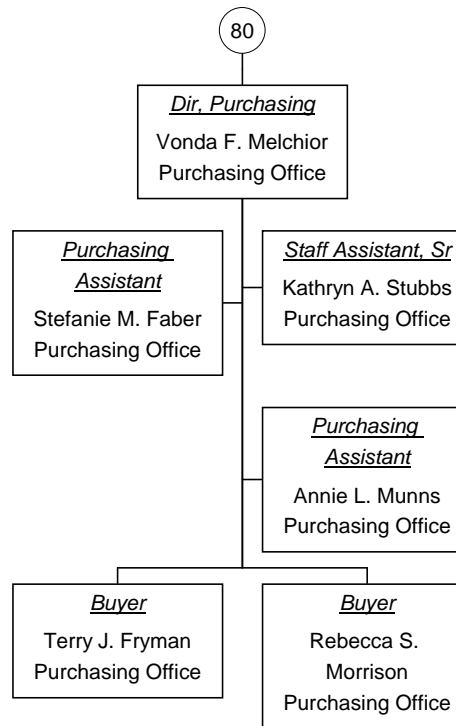

■ Vacant Position
■ Cabinet Position



Dir, Fac Plan/Const As of 11/02/2009

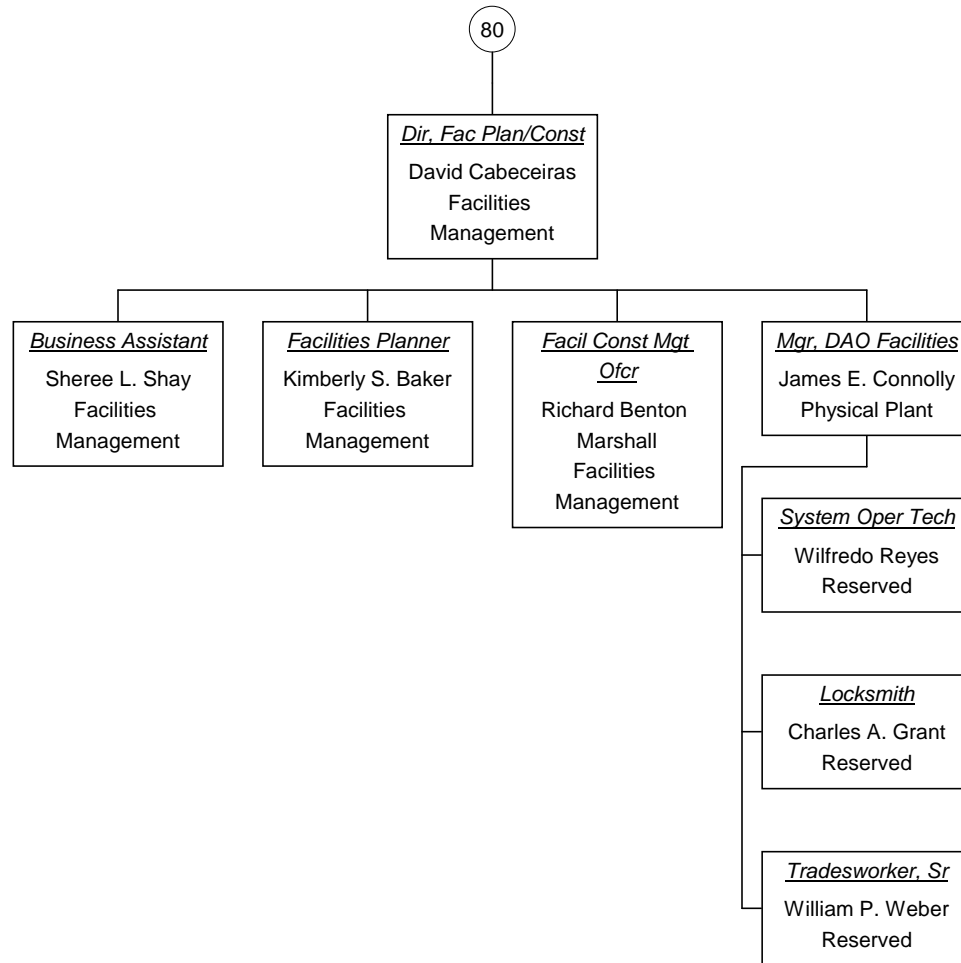

Vacant Position
 Cabinet Position



Mgr, Operations As of 11/02/2009

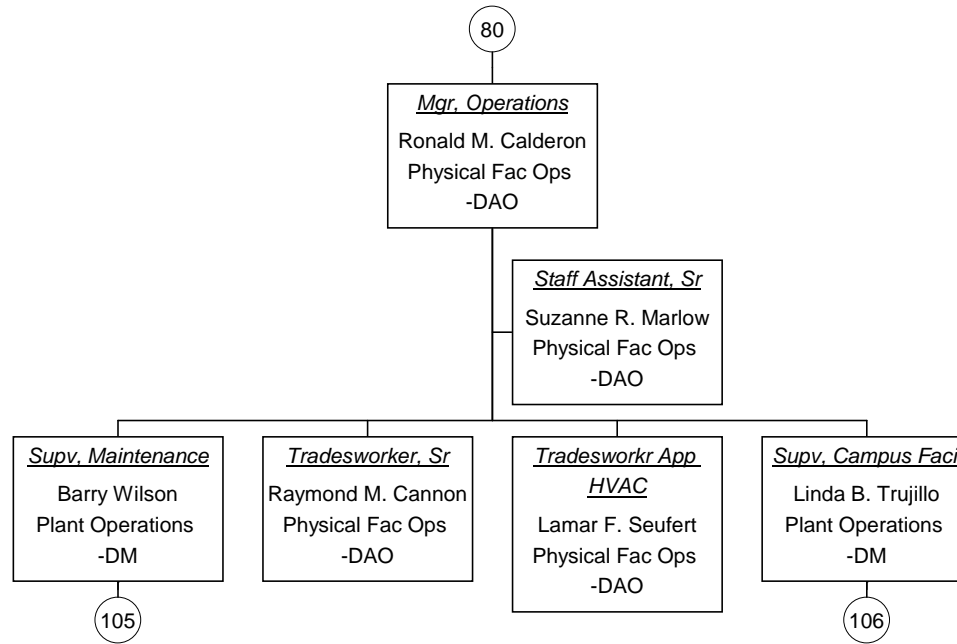

Vacant Position
Cabinet Position



**Supv, Maintenance As of
11/02/2009**

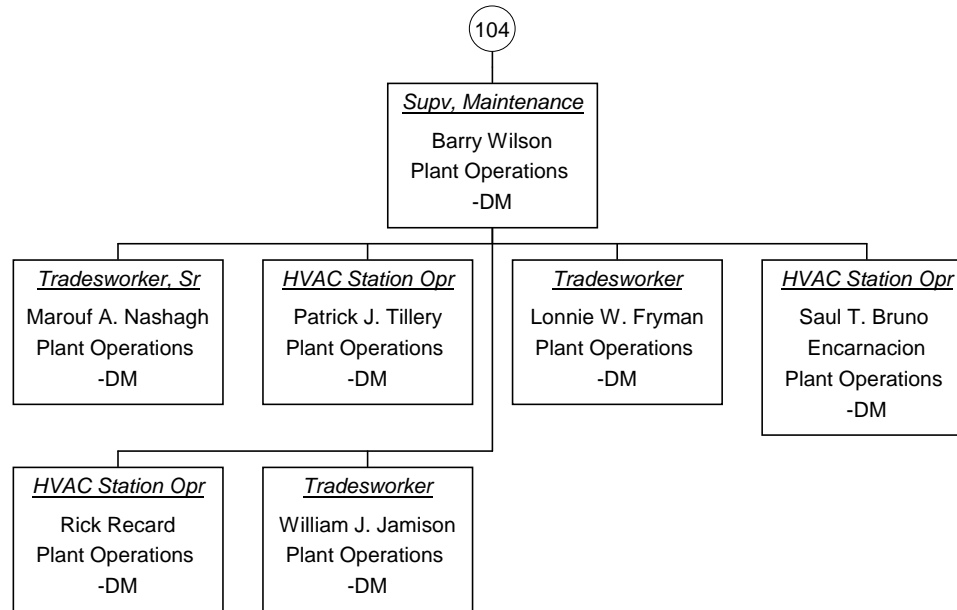

Vacant Position
 Cabinet Position



**Supv, Campus Facil As of
11/02/2009**

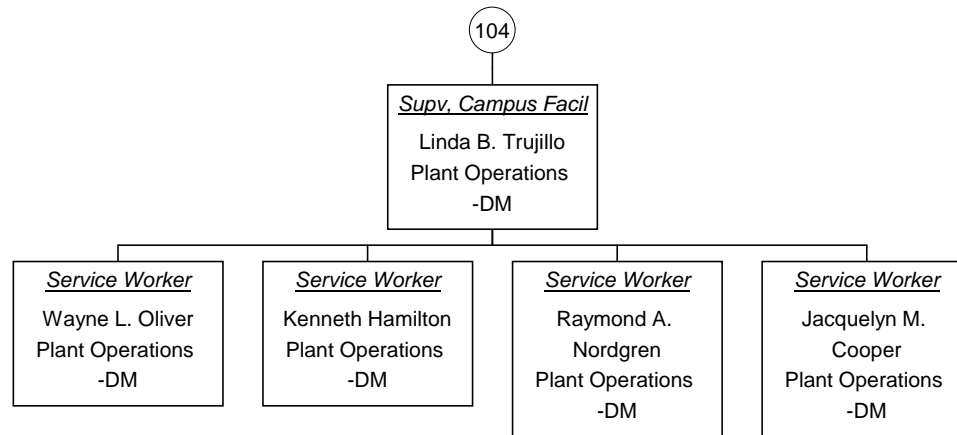

■ Vacant Position
■ Cabinet Position



VP, Info Technology As of 11/02/2009

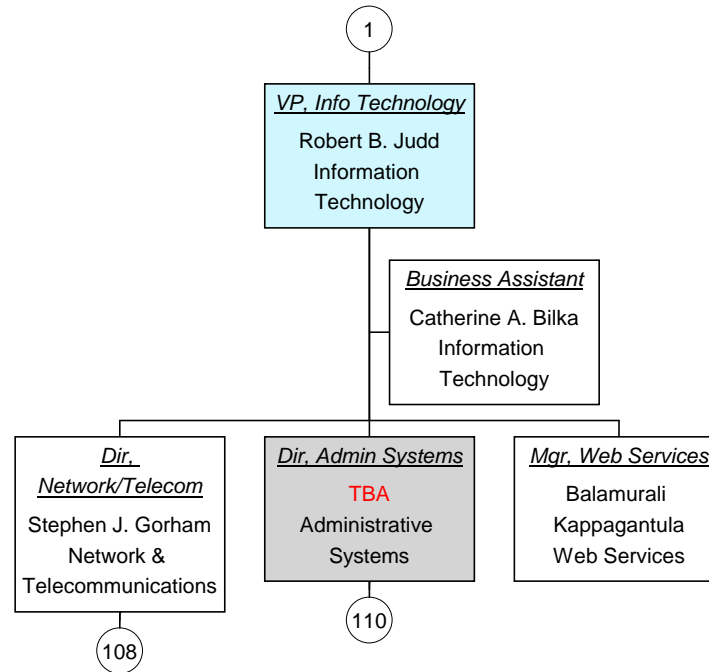

Vacant Position
Cabinet Position



**Dir, Network/Telecom As of
11/02/2009**

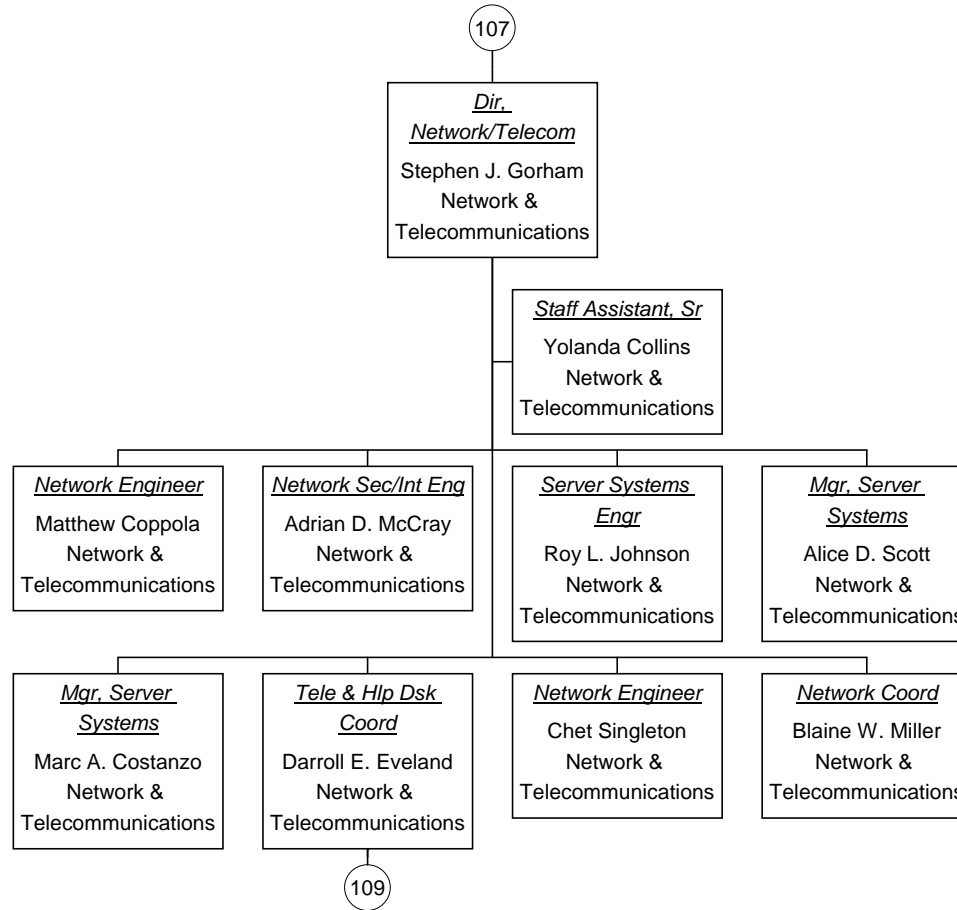

Vacant Position
 Cabinet Position



**Tele & Hlp Dsk Coord As of
11/02/2009**

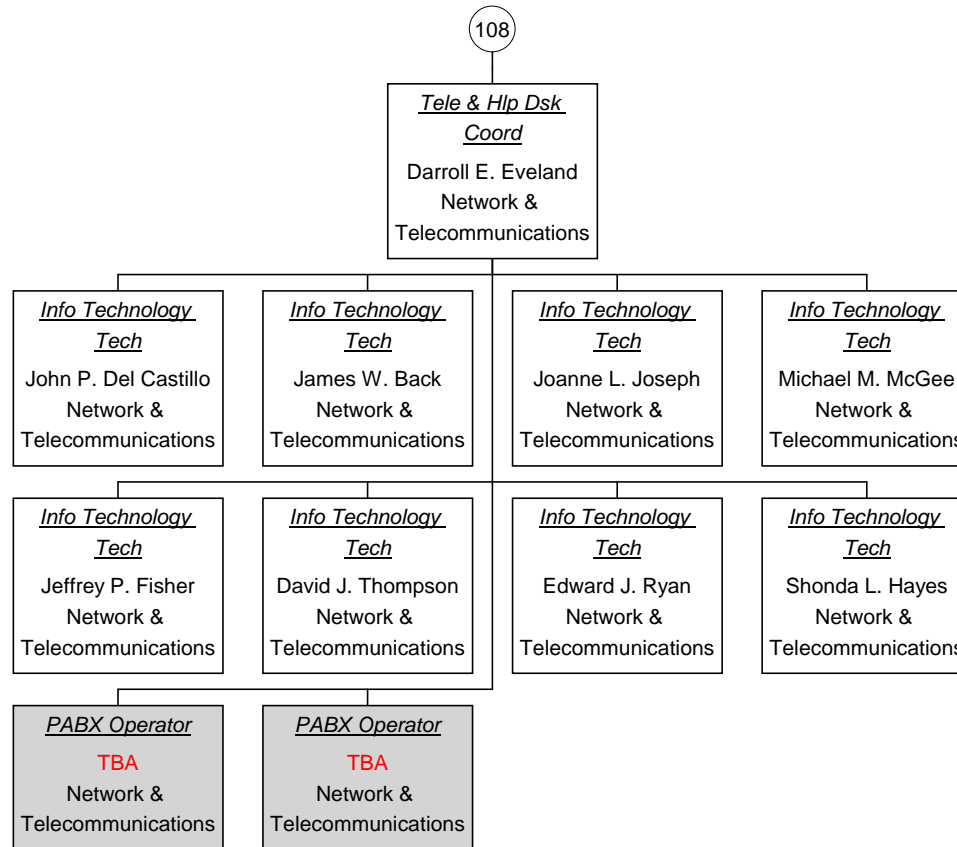

Vacant Position
 Cabinet Position



**Dir, Admin Systems As of
11/02/2009**

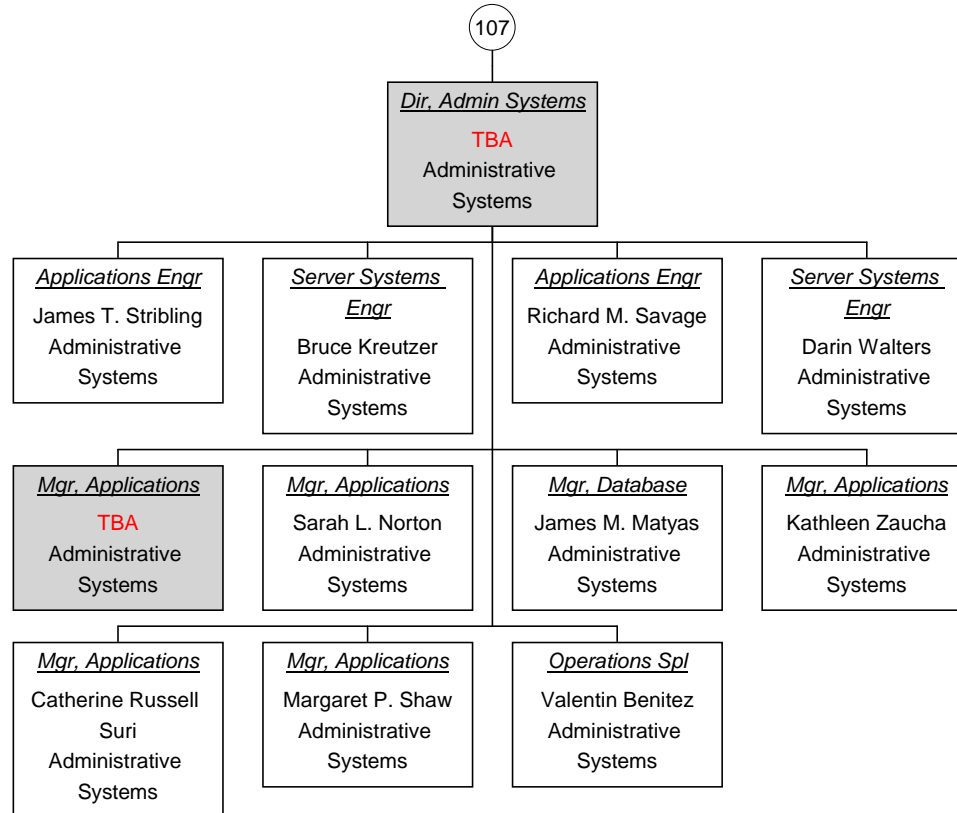

Vacant Position
 Cabinet Position



**Spl Asst to Pres As of
11/02/2009**

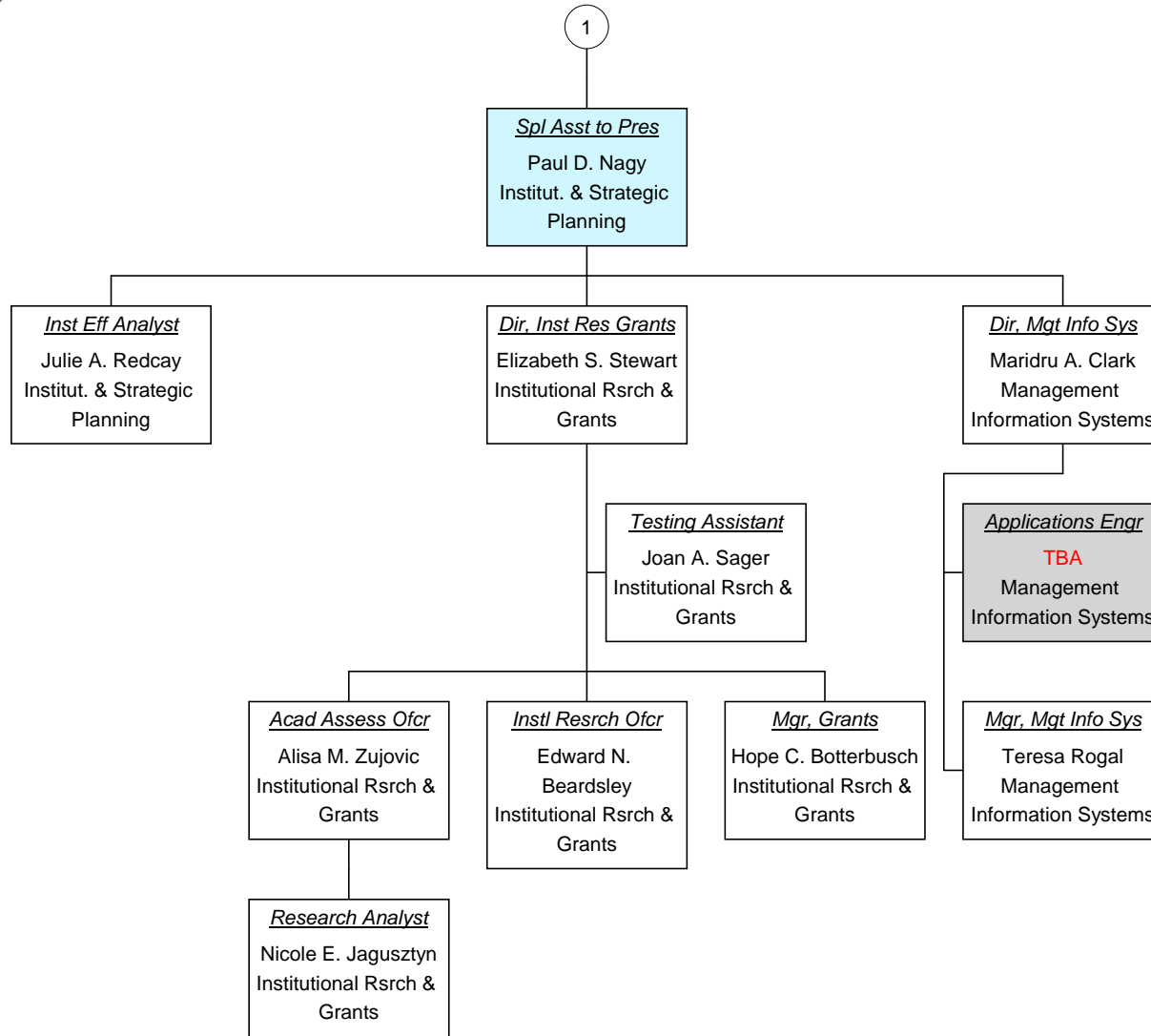

Vacant Position
 Cabinet Position



**ExDir, Human Rsrcs As of
11/02/2009**

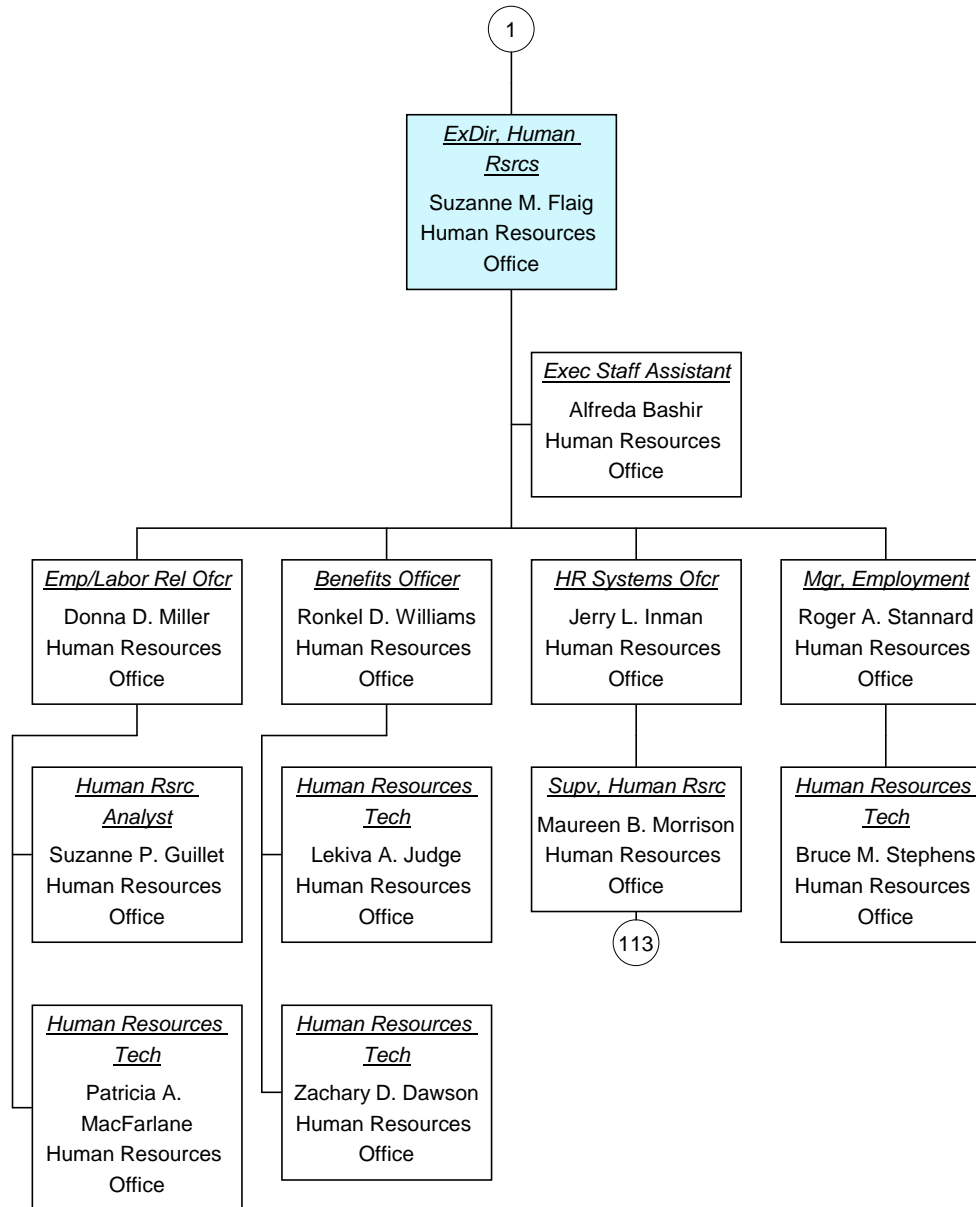

Vacant Position
 Cabinet Position



Supv, Human Rsrc As of 11/02/2009

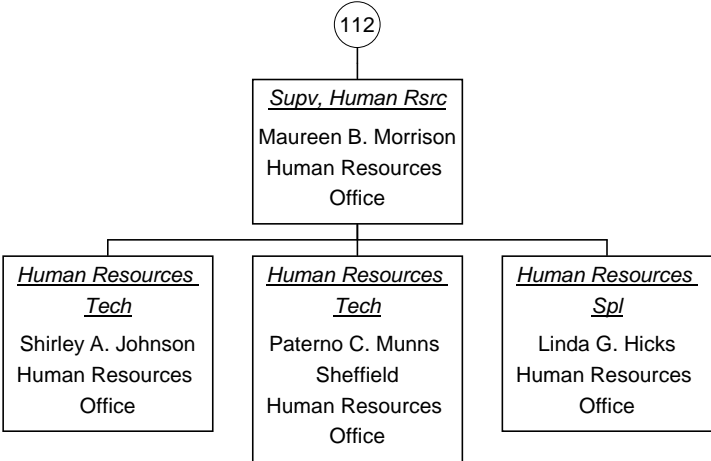

Vacant Position
 Cabinet Position



**ExDir, Mktg & PubRel As of
11/02/2009**

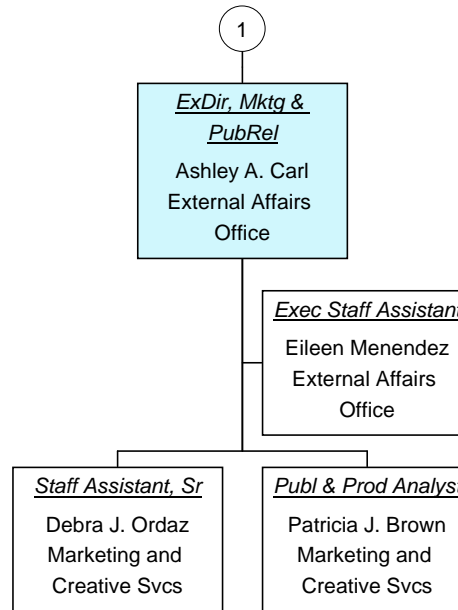

■ Vacant Position
■ Cabinet Position



**Exdir, Foundation As of
11/02/2009**

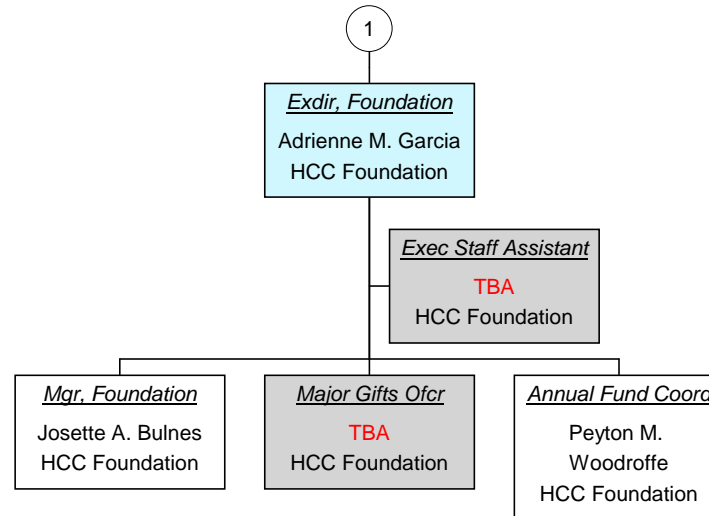

Vacant Position
 Cabinet Position