

HILLSBOROUGH

Community College



September 2008



College President As of
09/04/2008

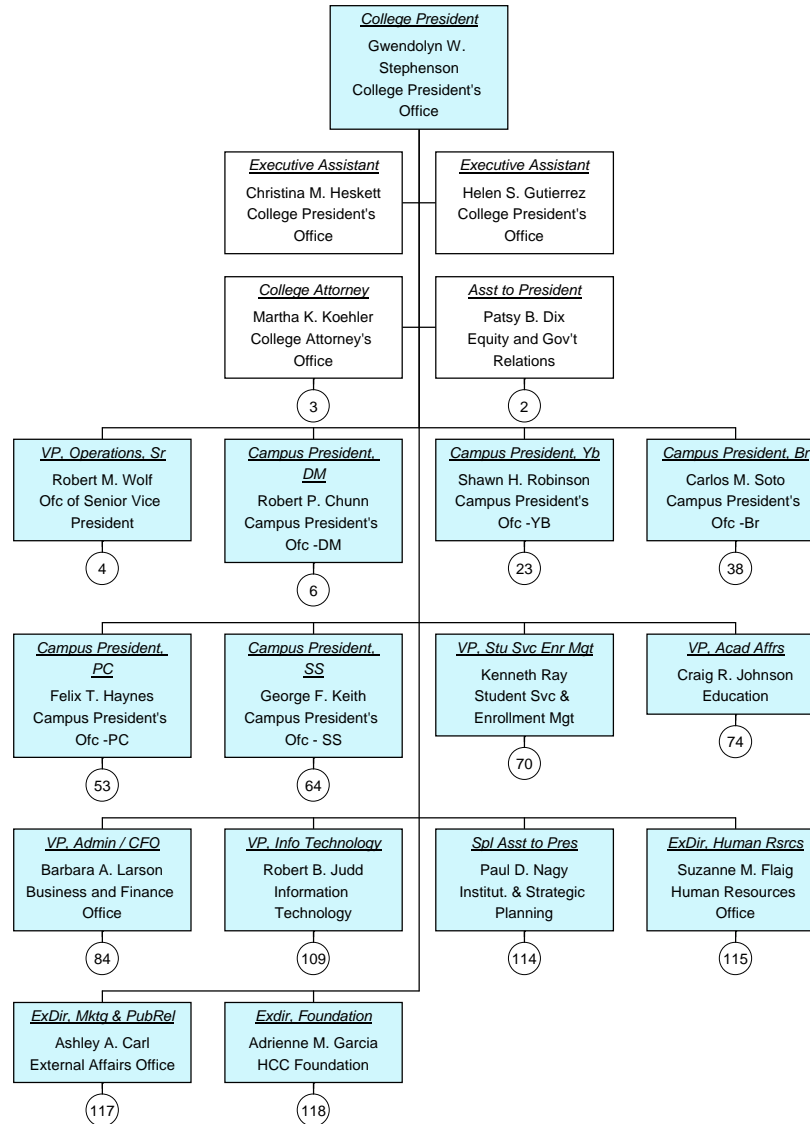

Vacant Position
Cabinet Position



**Asst to President As of
09/04/2008**

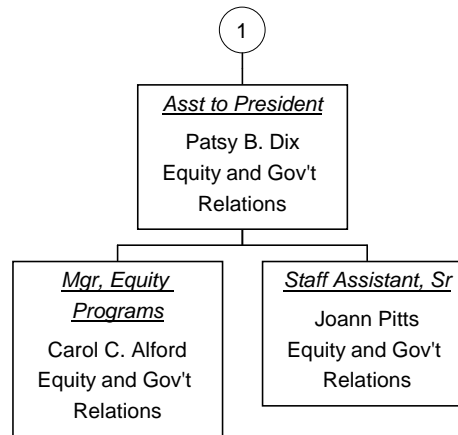

■ Vacant Position
■ Cabinet Position



**College Attorney As of
09/04/2008**

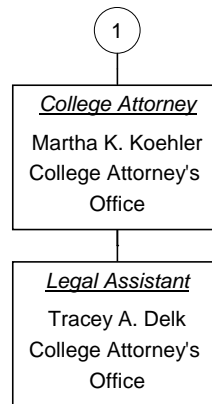

■ Vacant Position
■ Cabinet Position



VP, Operations, Sr As of
09/04/2008

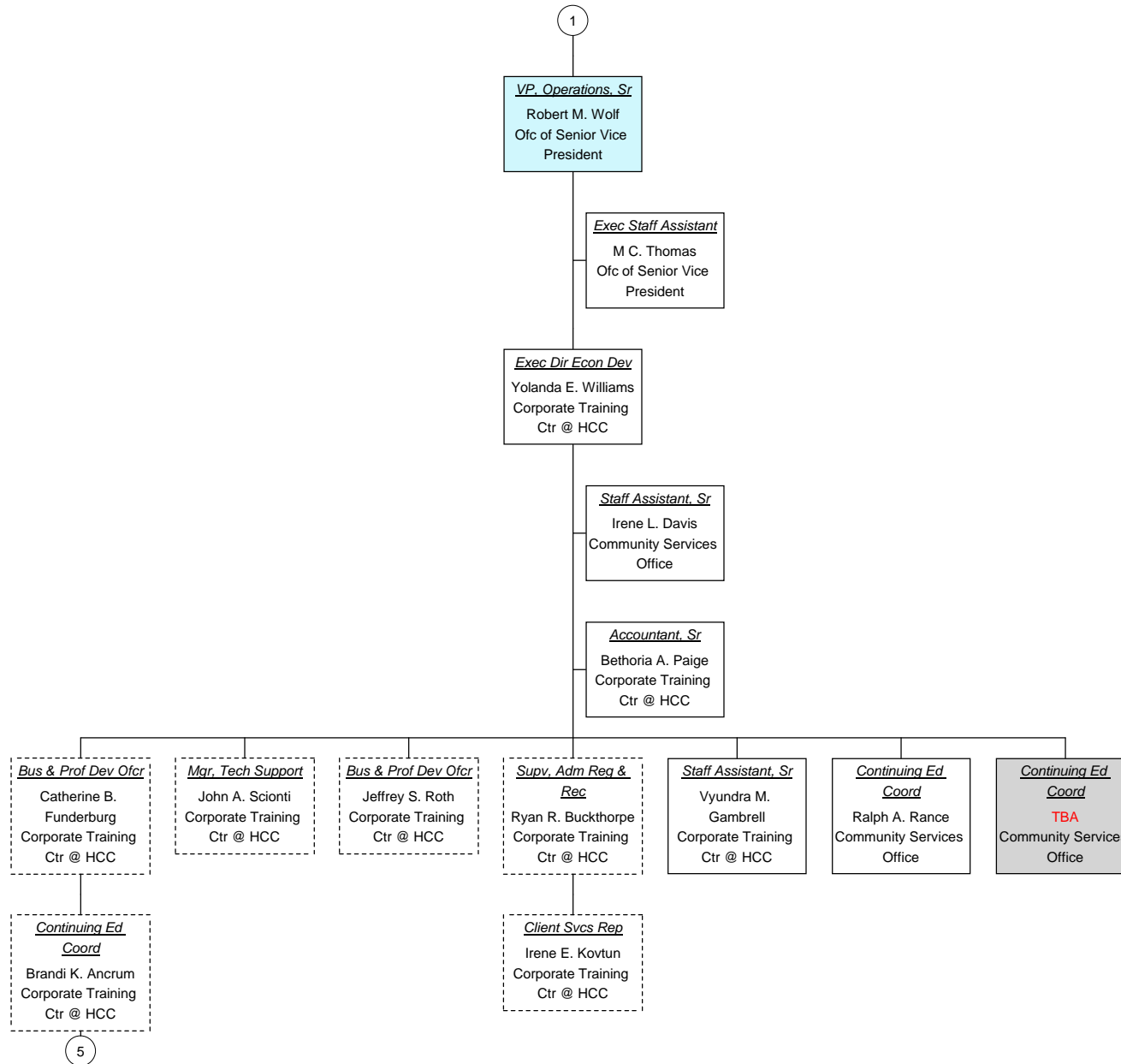

Vacant Position
 Cabinet Position



**Continuing Ed Coord As of
09/04/2008**

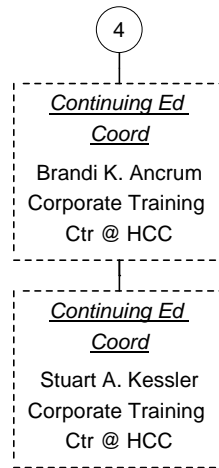

■ Vacant Position
■ Cabinet Position



**Campus President, DM As of
09/04/2008**

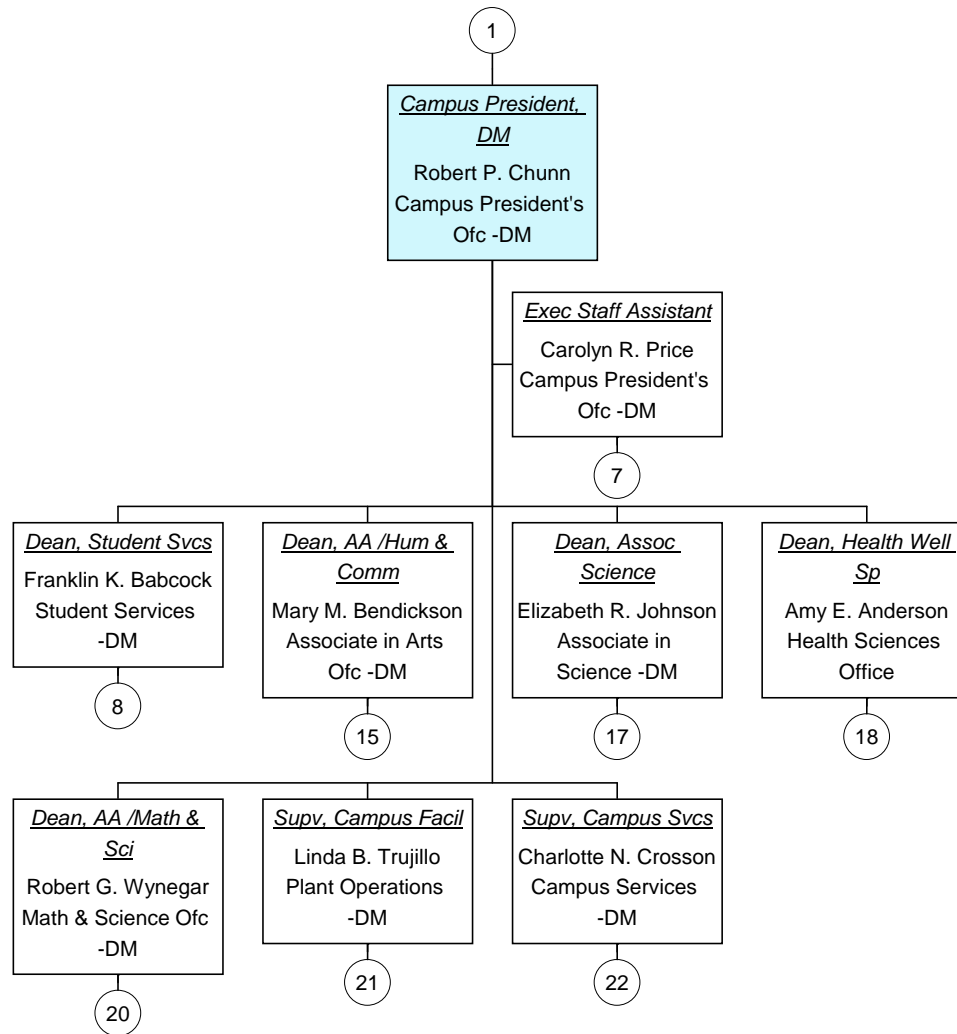

Vacant Position
 Cabinet Position



**Exec Staff Assistant As of
09/04/2008**

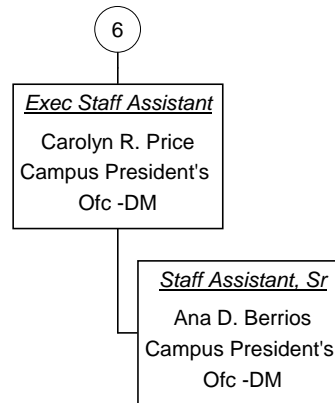

■ Vacant Position
■ Cabinet Position



Dean, Student Svcs As of
09/04/2008

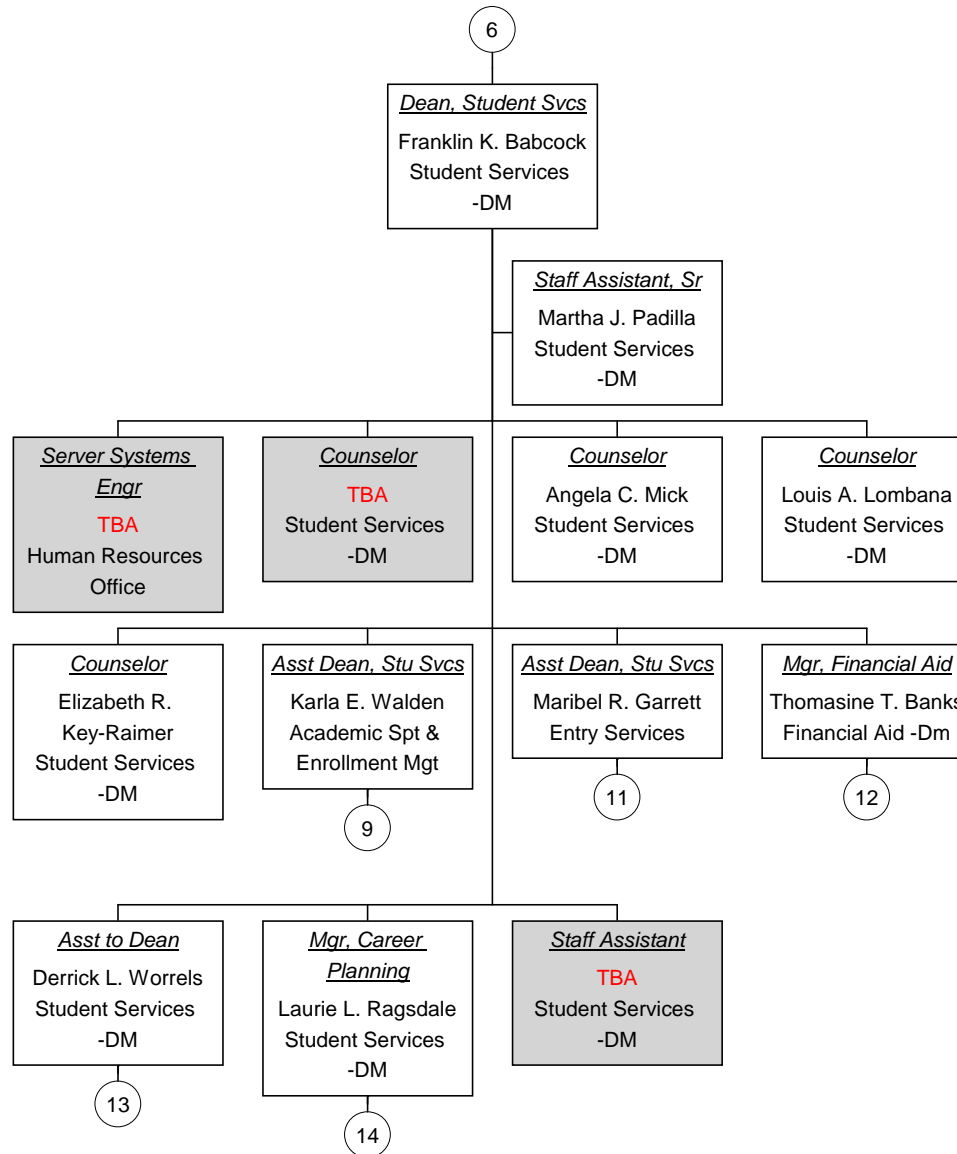

Vacant Position
 Cabinet Position



**Asst Dean, Stu Svcs As of
09/04/2008**

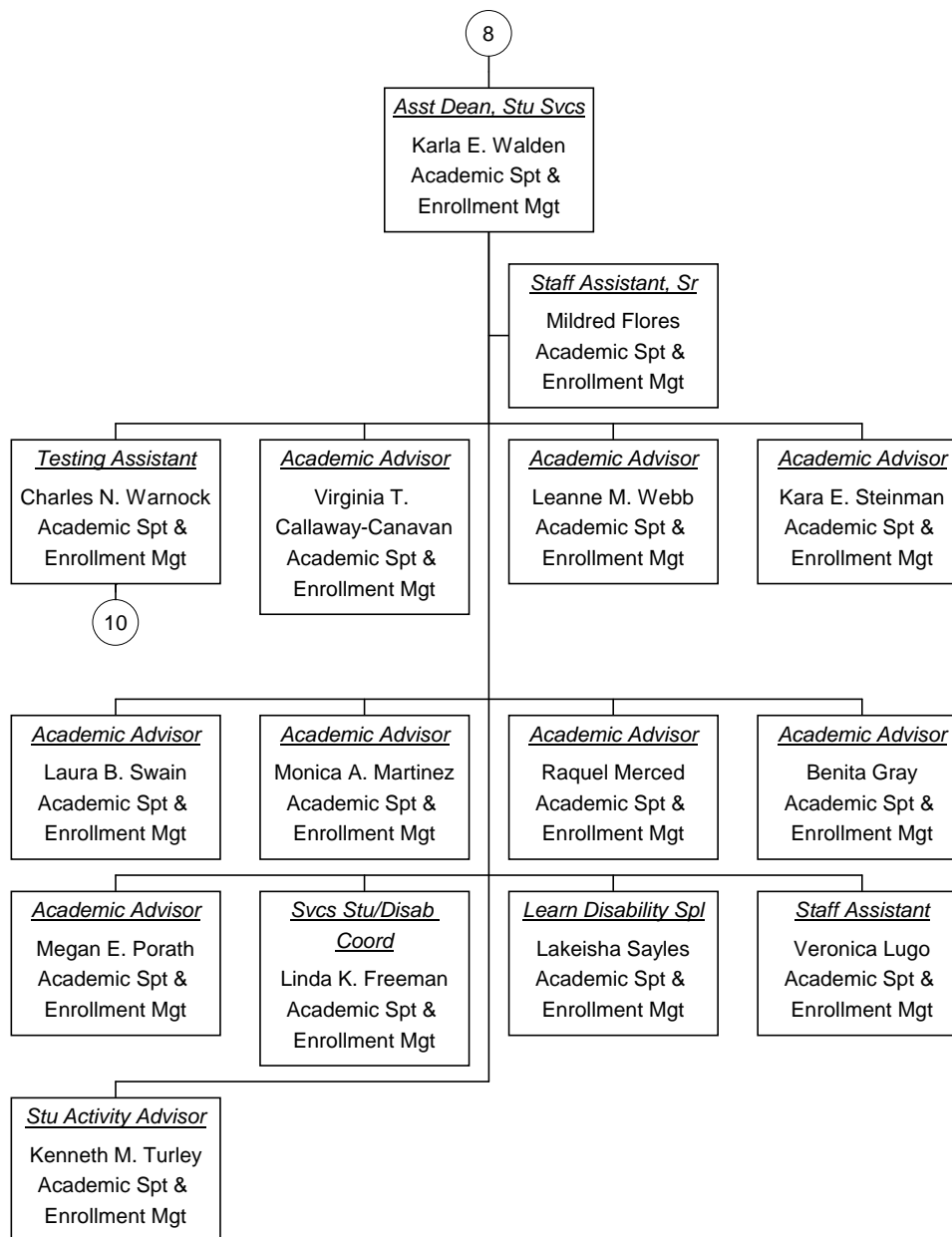

Vacant Position
 Cabinet Position



Testing Assistant As of
09/04/2008

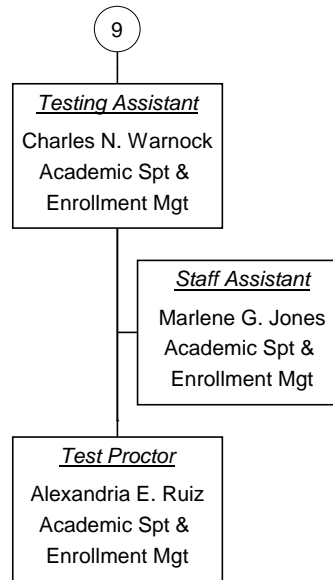

■ Vacant Position
■ Cabinet Position



**Asst Dean, Stu Svcs As of
09/04/2008**

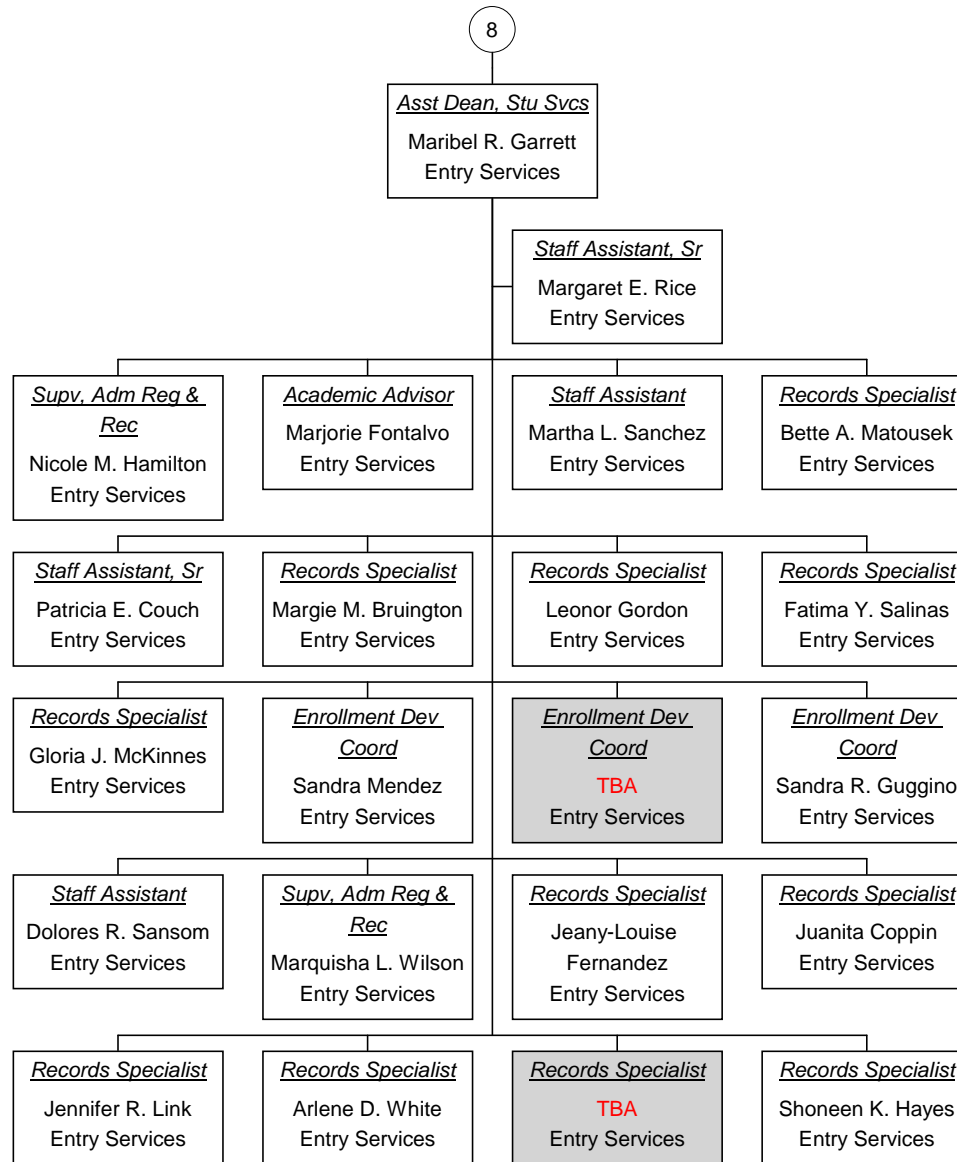

Vacant Position
 Cabinet Position



**Mgr, Financial Aid As of
09/04/2008**

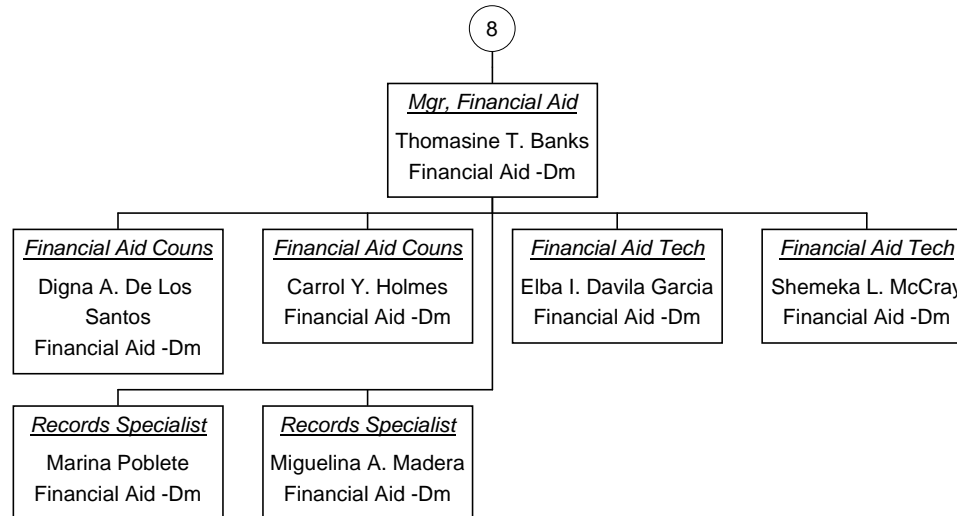

■ Vacant Position
■ Cabinet Position



Asst to Dean As of 09/04/2008

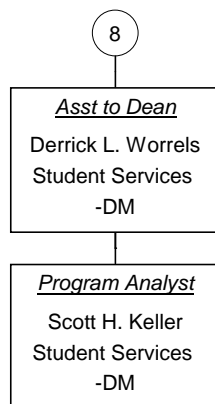

Vacant Position
Cabinet Position



**Mgr, Career Planning As of
09/04/2008**

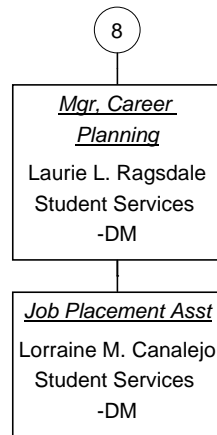

■ Vacant Position
■ Cabinet Position

Dean, AA/Hum & Comm As of
09/04/2008

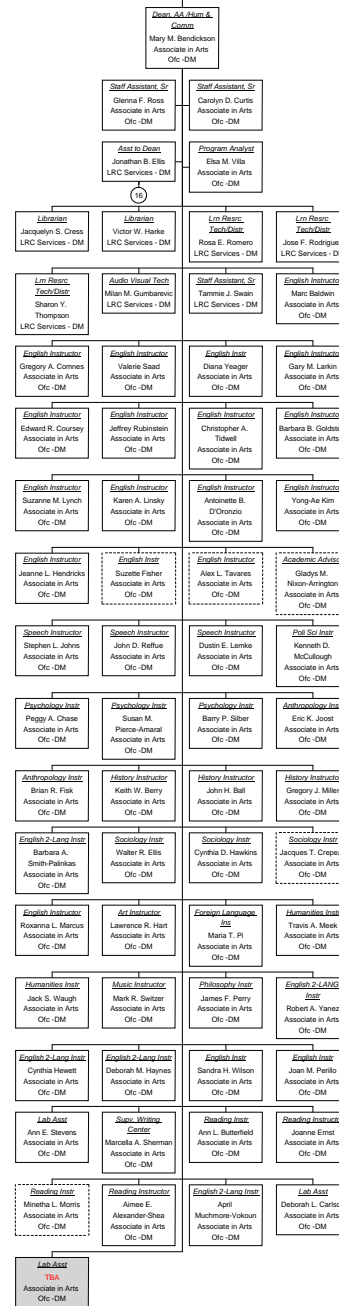

Vacant Position
Cabinet Position



Asst to Dean As of 09/04/2008

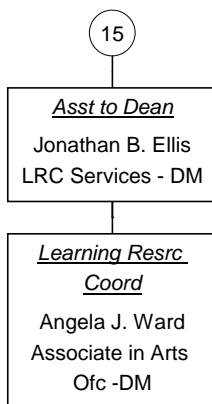

Vacant Position
Cabinet Position



Dean, Assoc Science As of
09/04/2008

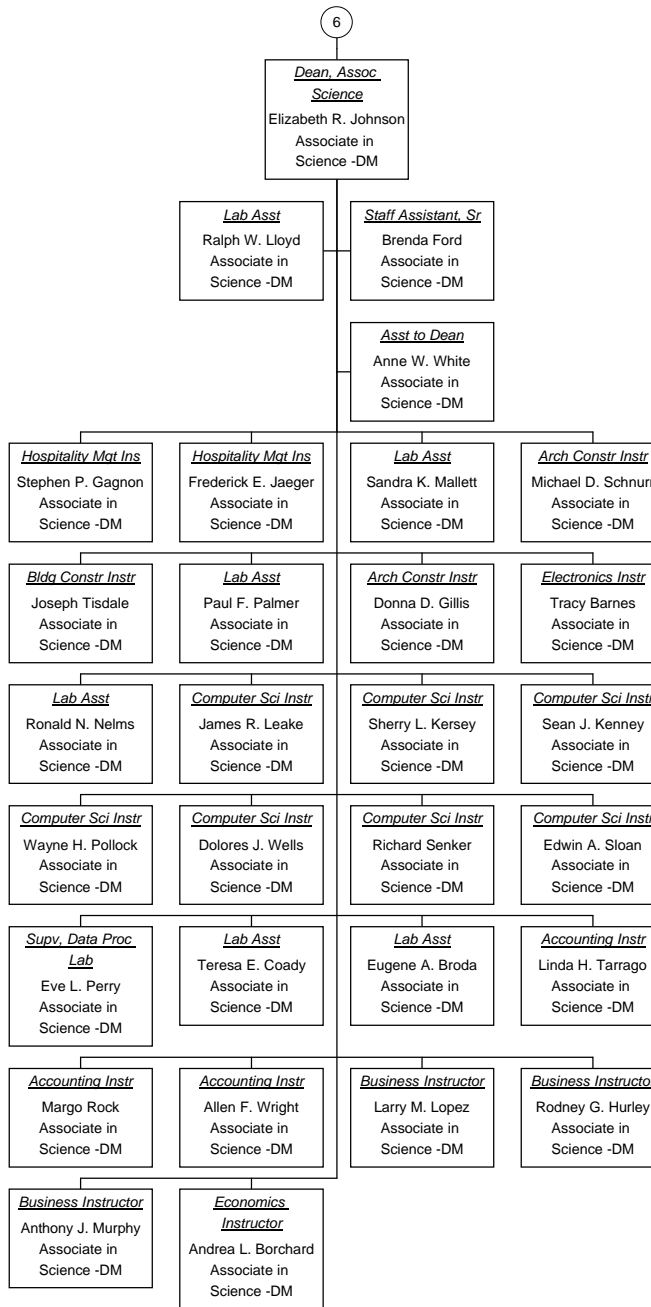

Vacant Position
Cabinet Position

Dean, Health Well Sp As of
09/04/2008

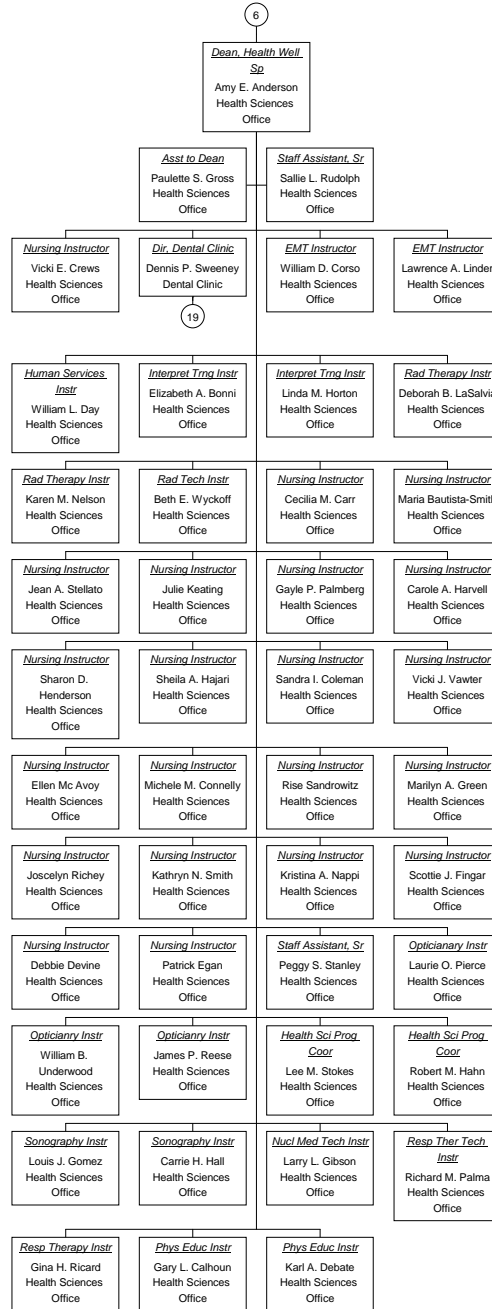

Vacant Position
Cabinet Position



**Dir, Dental Clinic As of
09/04/2008**

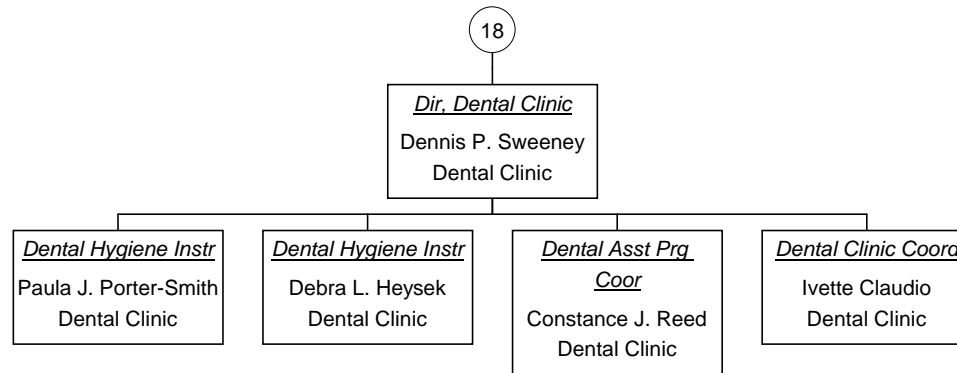

■ Vacant Position
■ Cabinet Position

Dean, AA /Math & Sci as of
09/04/2008

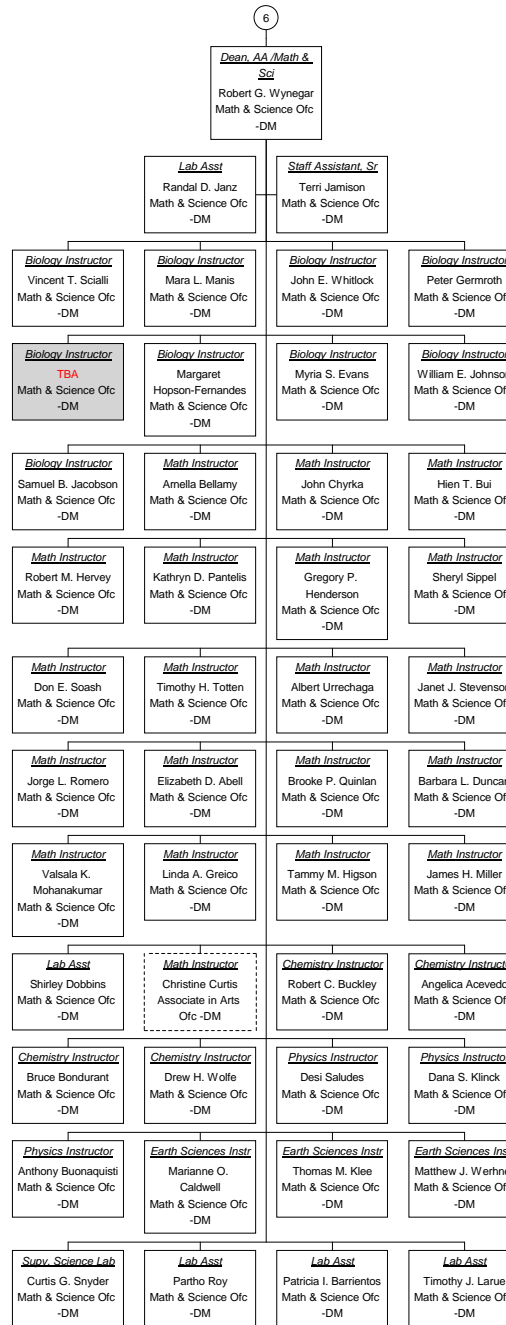

Vacant Position
Cabinet Position



**Supv, Campus Facil As of
09/04/2008**

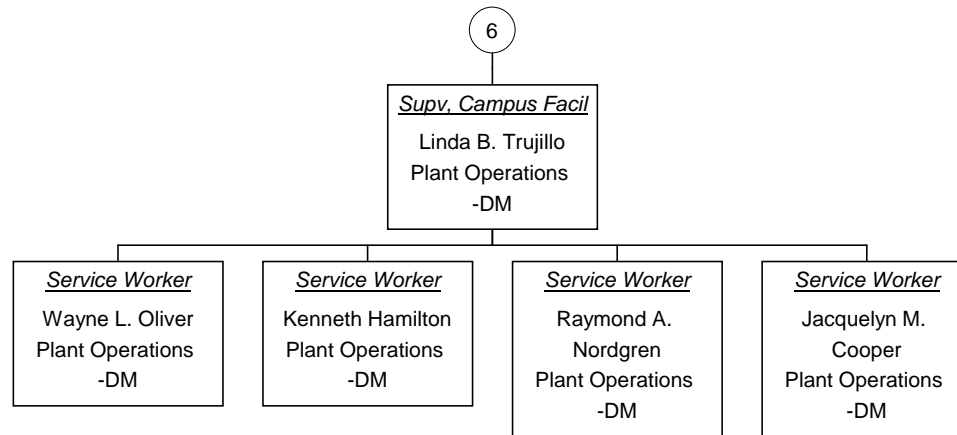

■ Vacant Position
■ Cabinet Position



**Supv, Campus Svcs As of
09/04/2008**

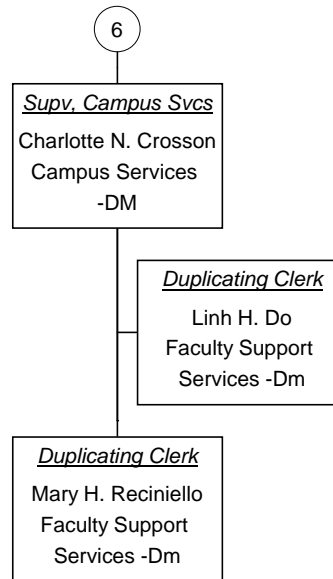

■ Vacant Position
■ Cabinet Position



**Campus President, Yb As of
09/04/2008**

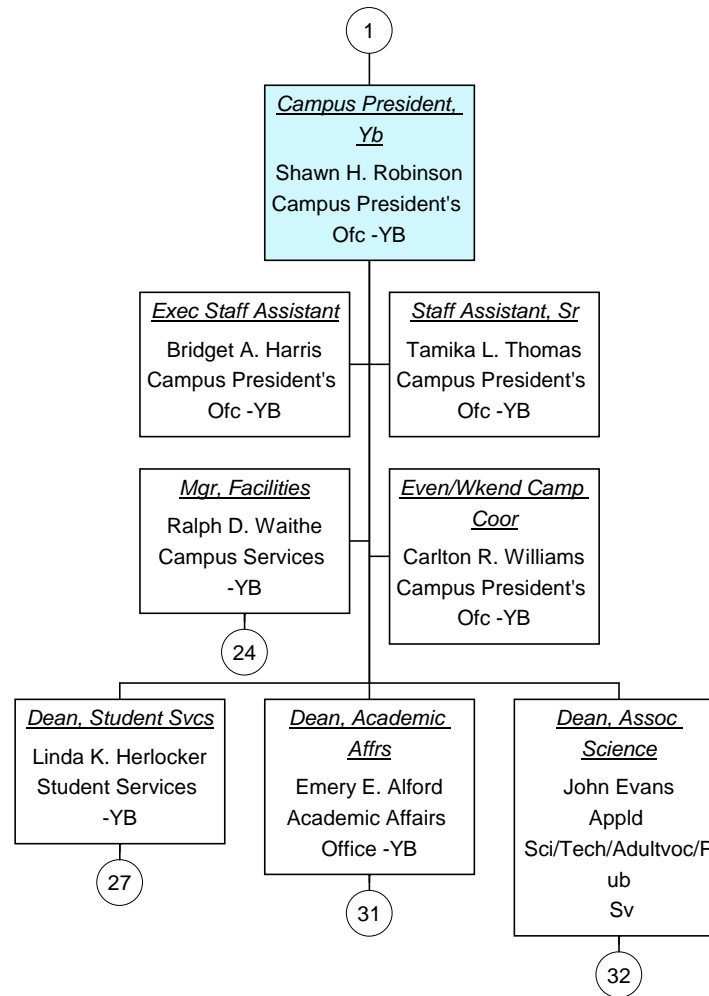

Vacant Position
 Cabinet Position

Mgr, Facilities As of 09/04/2008

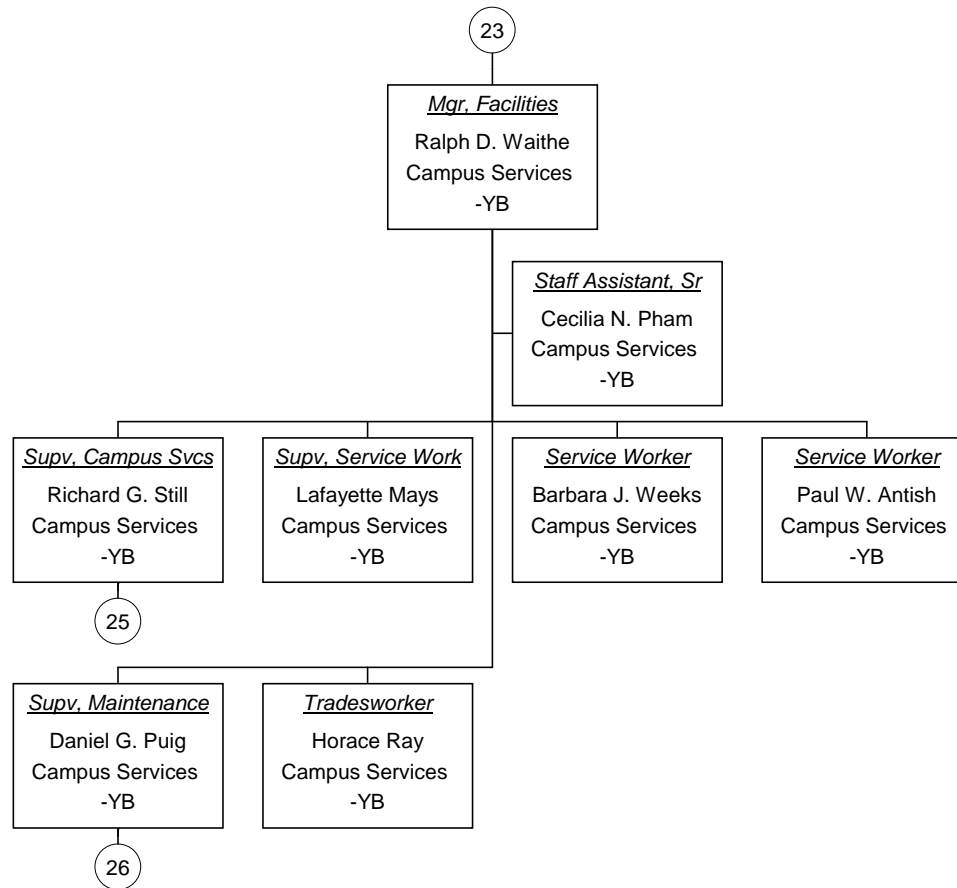

Vacant Position
 Cabinet Position



**Supv, Campus Svcs As of
09/04/2008**

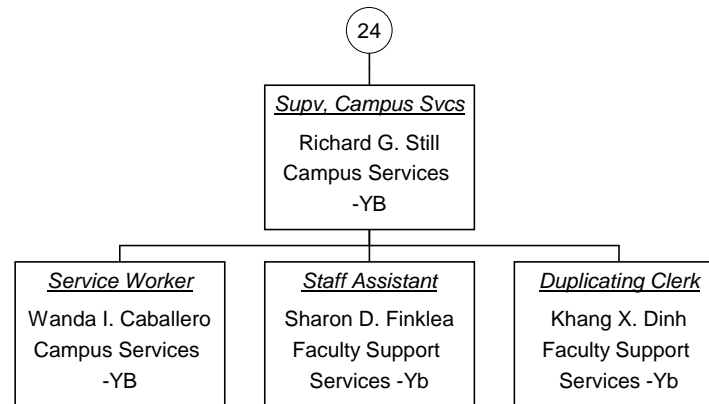

■ Vacant Position
■ Cabinet Position



Supv, Maintenance As of 09/04/2008

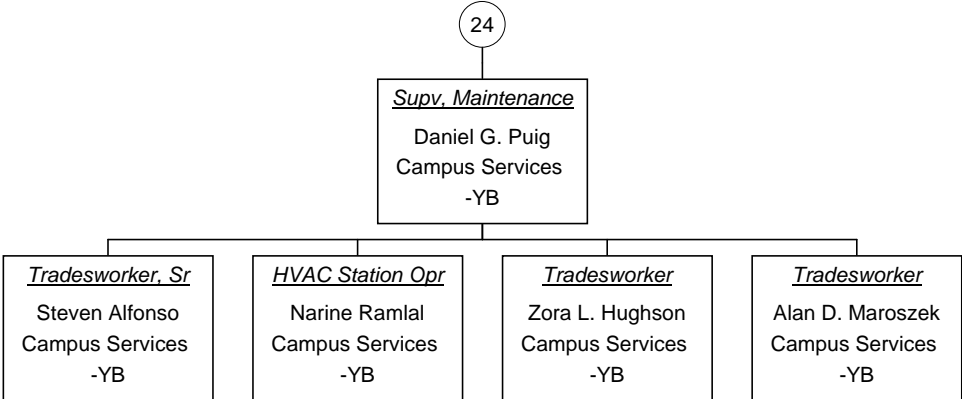

Vacant Position
 Cabinet Position



**Dean, Student Svcs As of
09/04/2008**

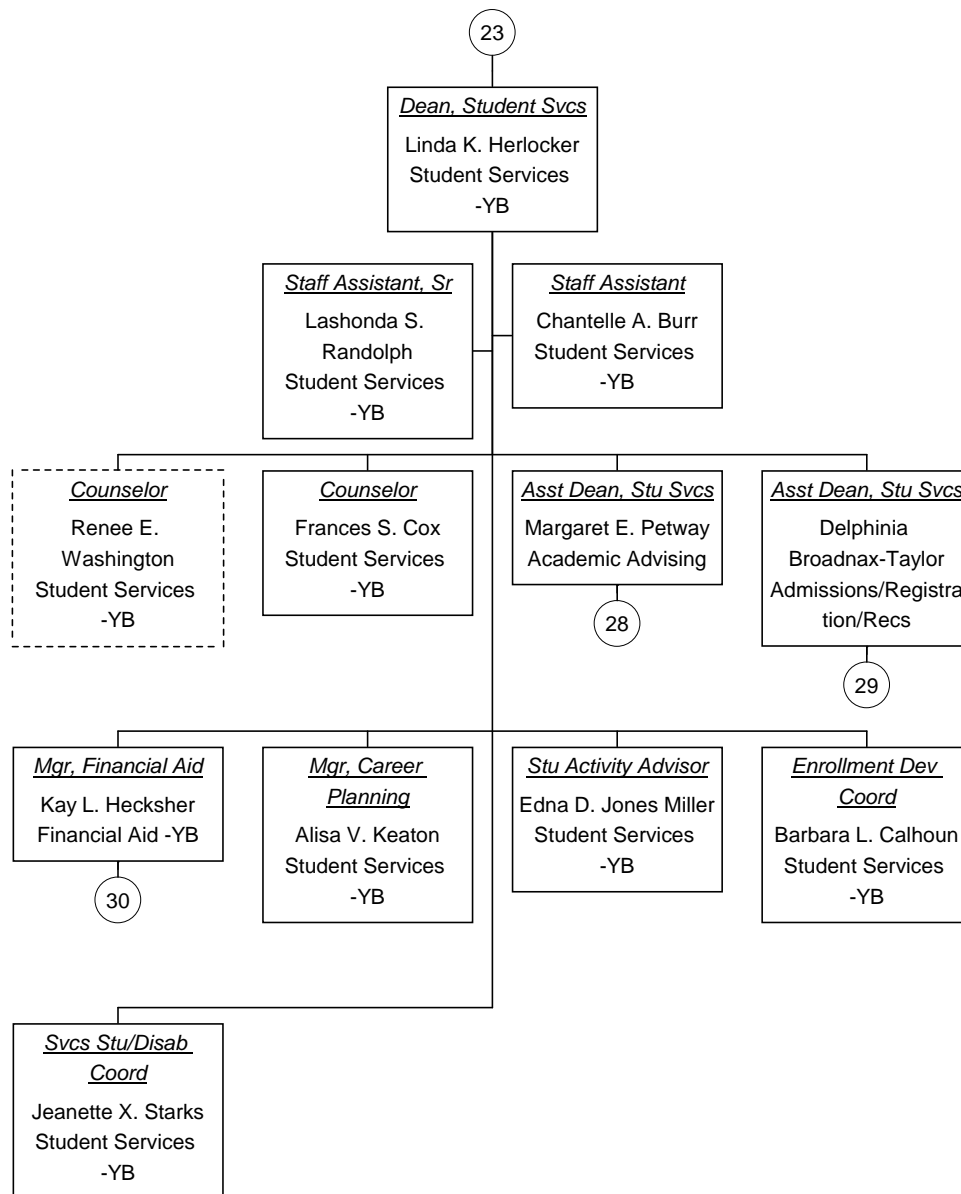

Vacant Position
 Cabinet Position



**Asst Dean, Stu Svcs As of
09/04/2008**

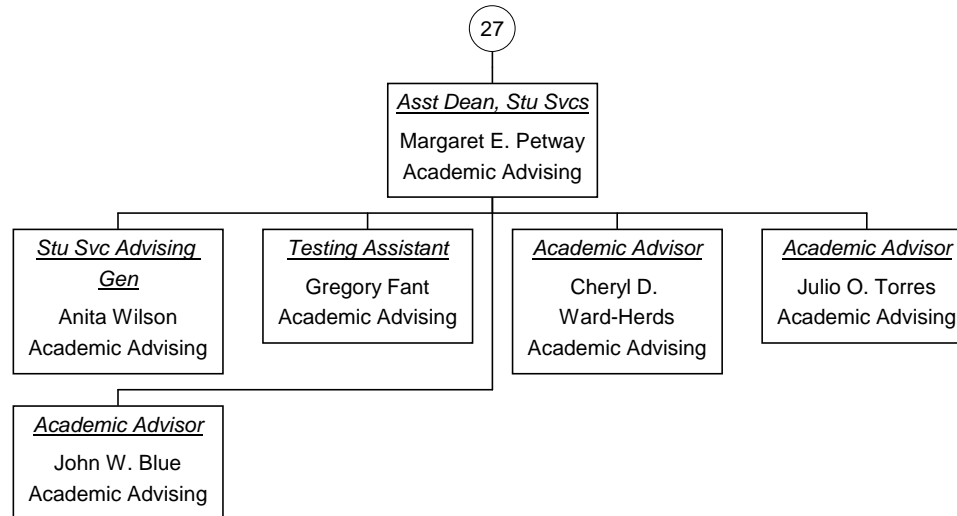

Vacant Position
 Cabinet Position



**Asst Dean, Stu Svcs As of
09/04/2008**

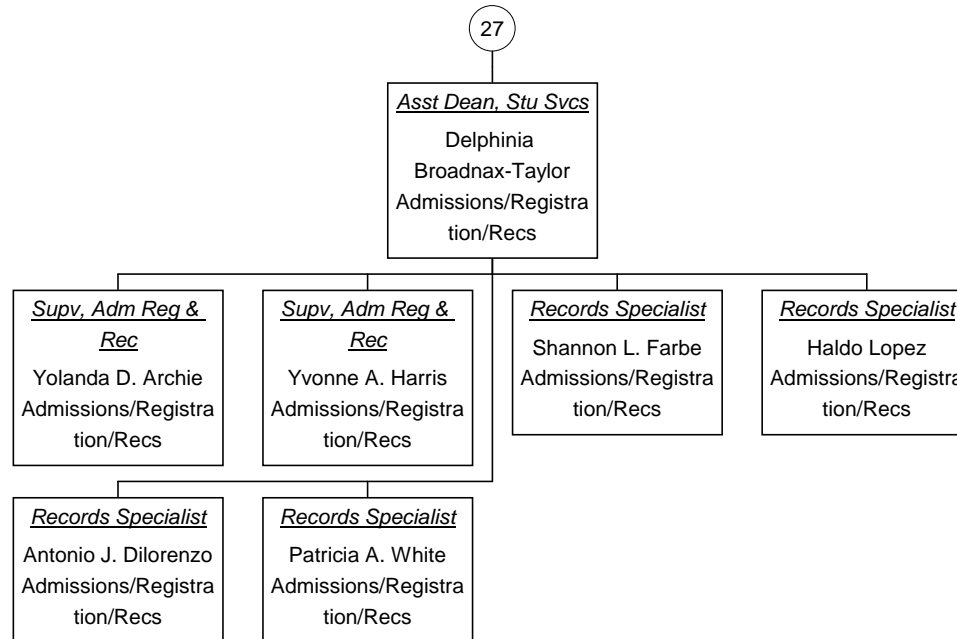

Vacant Position
 Cabinet Position



**Mgr, Financial Aid As of
09/04/2008**

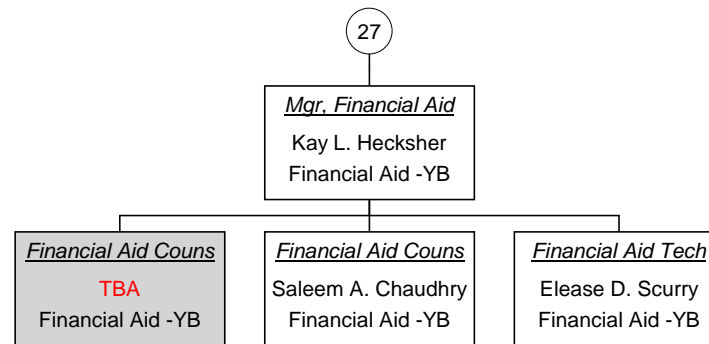

■ Vacant Position
■ Cabinet Position

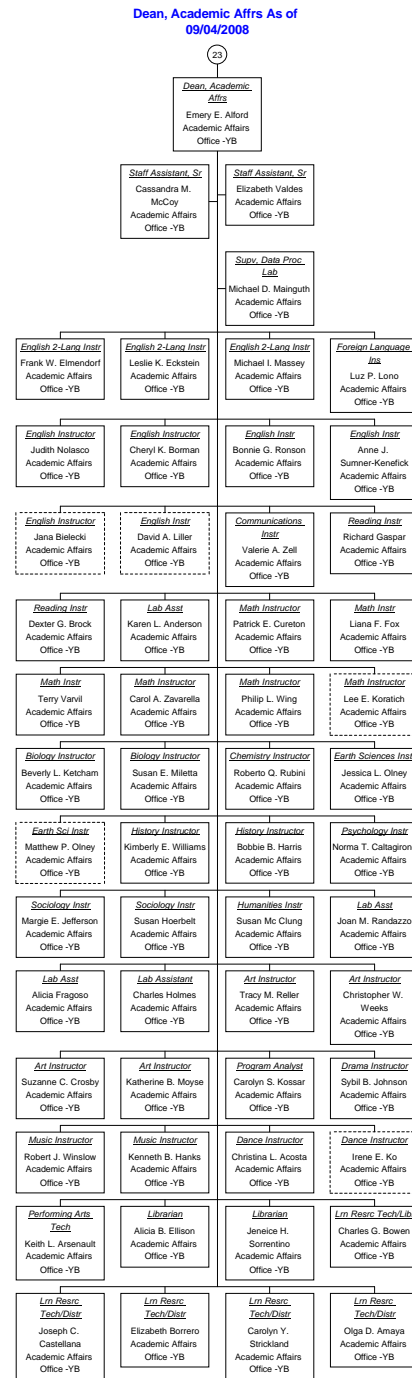

Vacant Position
Cabinet Position
Dotted border = Temp Position

Dean, Assoc Science As of
09/04/2008

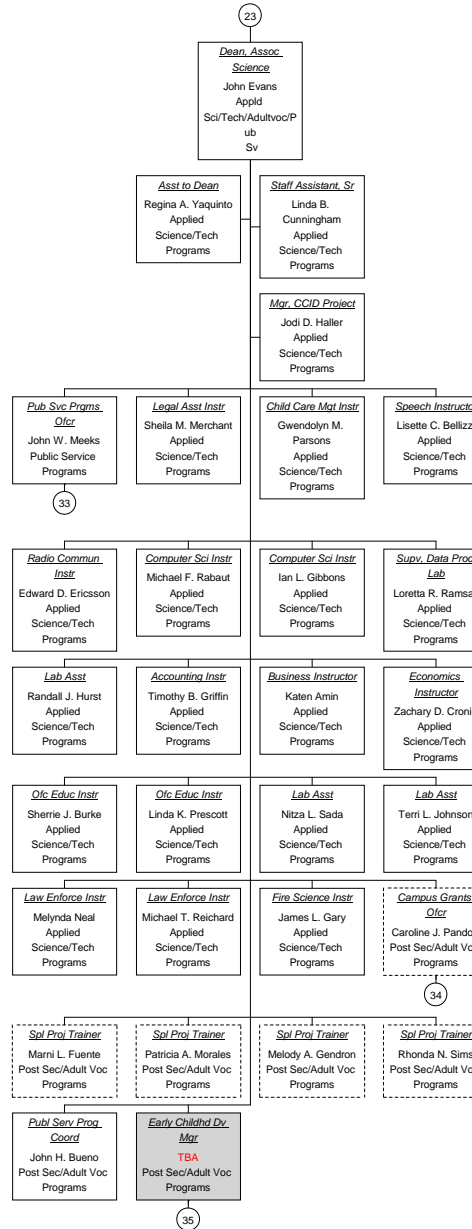

Vacant Position
Cabinet Position



**Pub Svc Prgms Ofcr As of
09/04/2008**

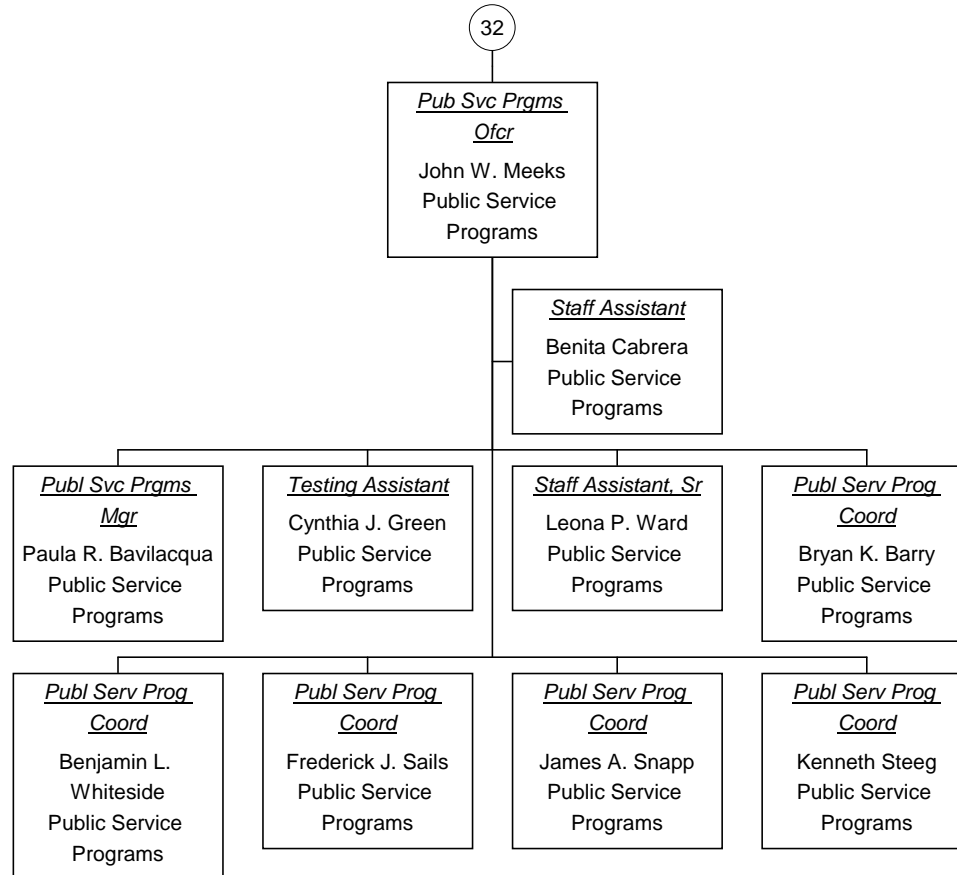

Vacant Position
 Cabinet Position



**Campus Grants Ofcr As of
09/04/2008**

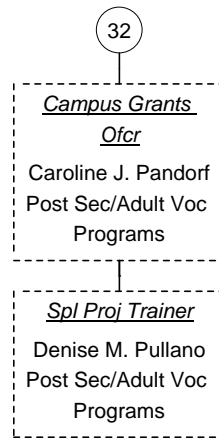

■ Vacant Position
■ Cabinet Position



Early Childhd Dv Mgr As of
09/04/2008

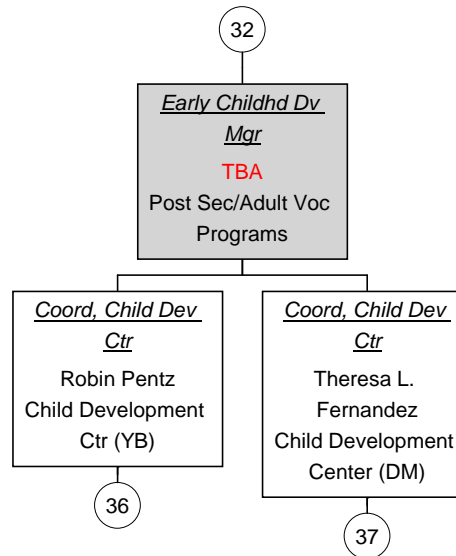

■ Vacant Position
■ Cabinet Position



**Coord, Child Dev Ctr As of
09/04/2008**

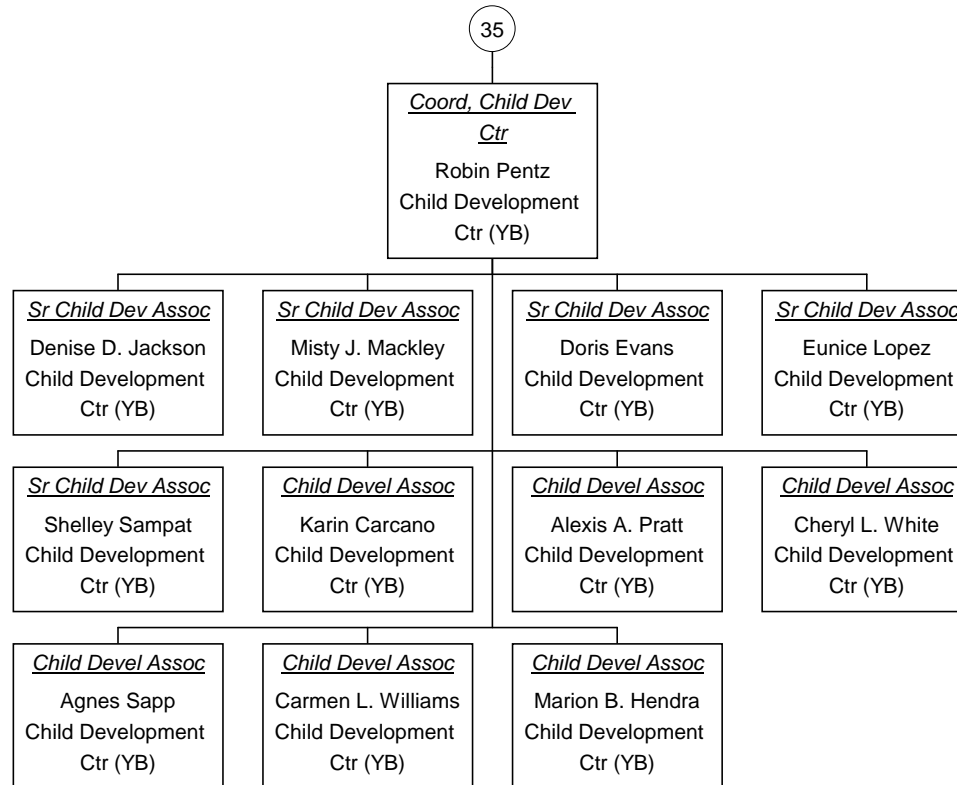

Vacant Position
 Cabinet Position



**Coord, Child Dev Ctr As of
09/04/2008**

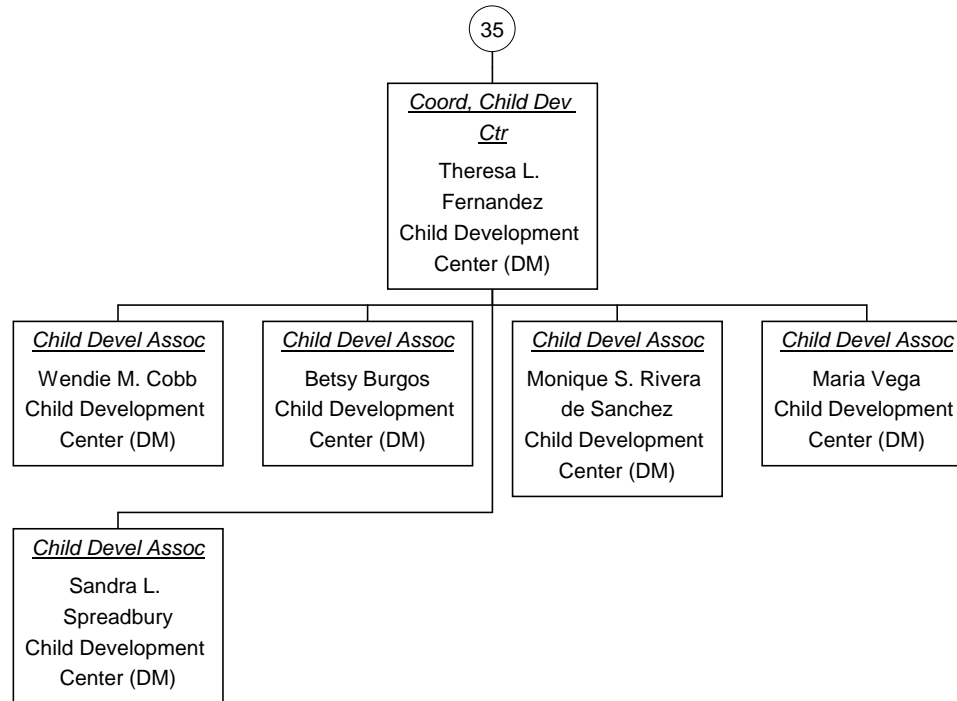

■ Vacant Position
■ Cabinet Position



**Campus President, Br As of
09/04/2008**

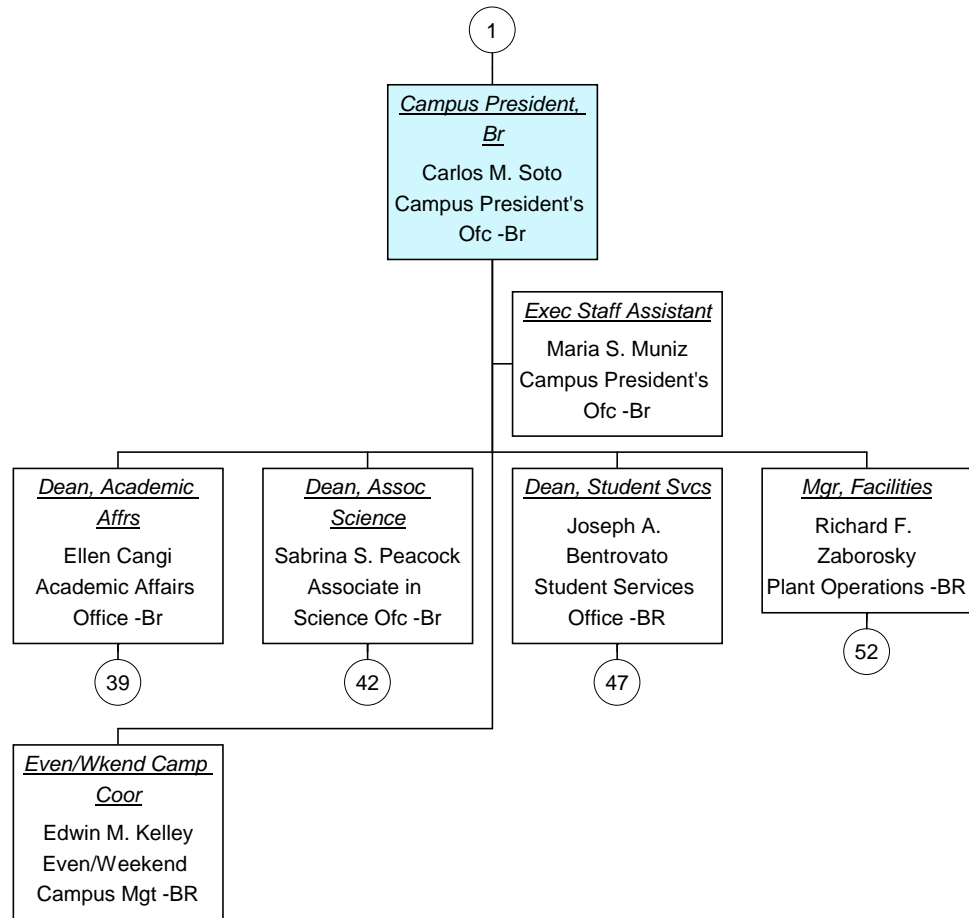

Vacant Position
 Cabinet Position

Dean, Academic Affrs As of
09/04/2008

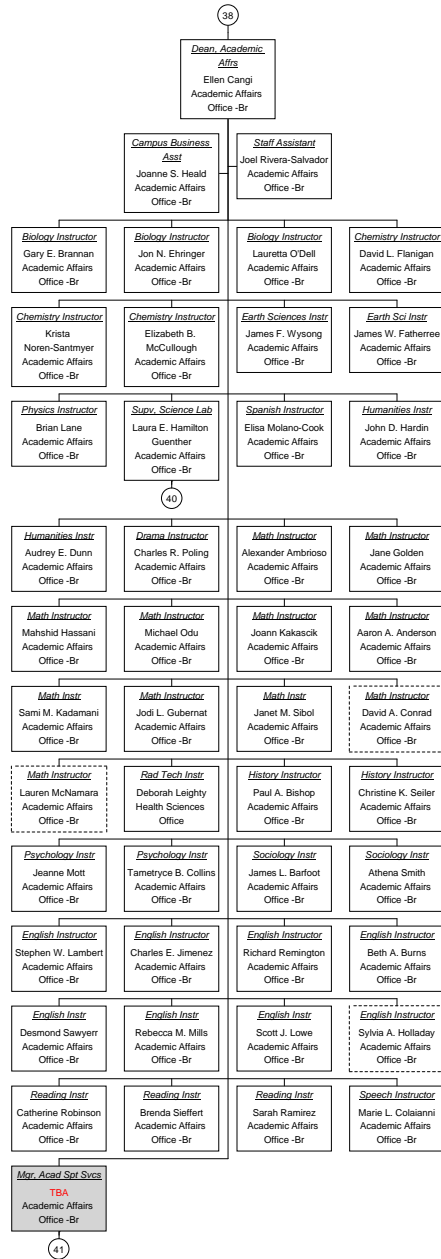

Vacant Position
Cabinet Position



**Supv, Science Lab As of
09/04/2008**

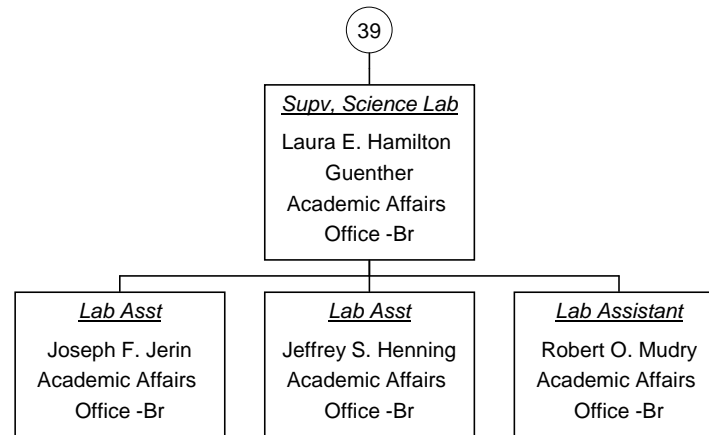

■ Vacant Position
■ Cabinet Position



**Mgr, Acad Spt Svcs As of
09/04/2008**

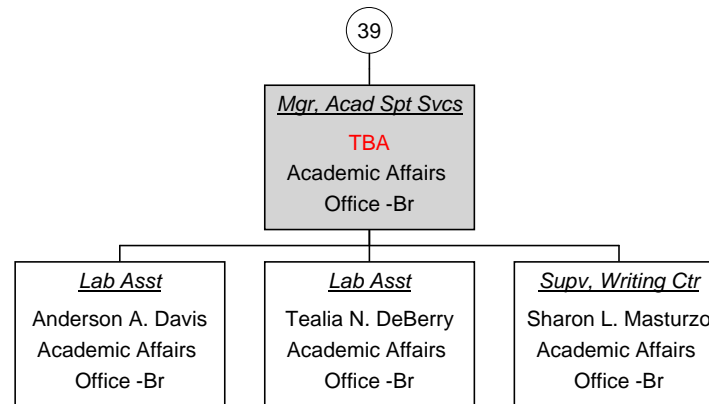

■ Vacant Position
■ Cabinet Position

Dean, Assoc Science As of
09/04/2008

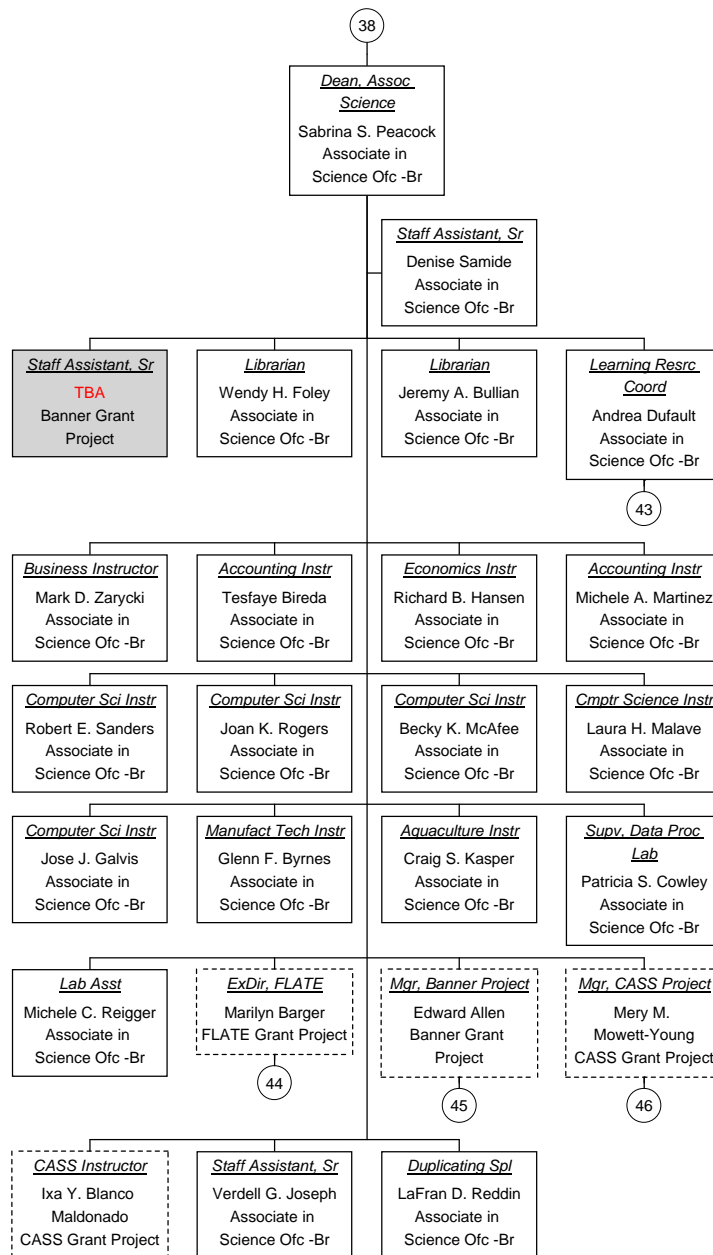

 Vacant Position
 Cabinet Position



**Learning Resrc Coord As of
09/04/2008**

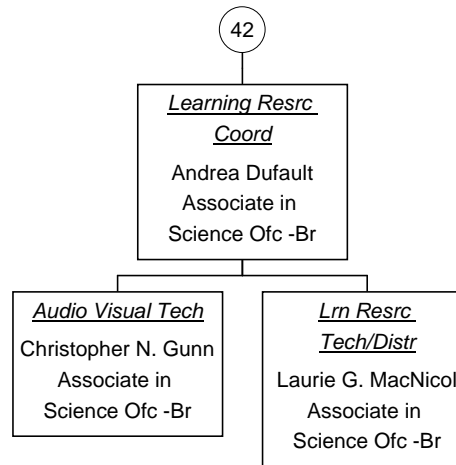

■ Vacant Position
■ Cabinet Position



ExDir, FLATE As of 09/04/2008

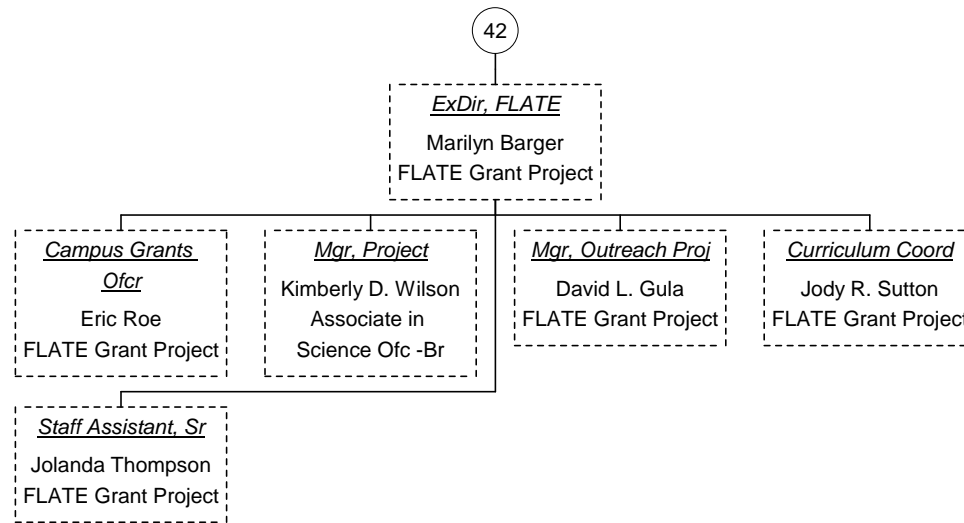

Vacant Position
 Cabinet Position



**Mgr, Banner Project As of
09/04/2008**

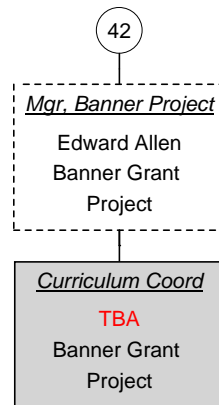

■ Vacant Position
■ Cabinet Position



**Mgr, CASS Project As of
09/04/2008**

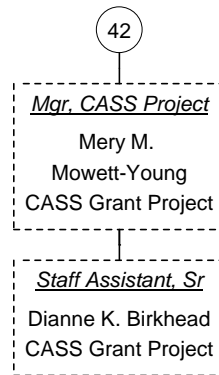

■ Vacant Position
■ Cabinet Position



**Dean, Student Svcs As of
09/04/2008**

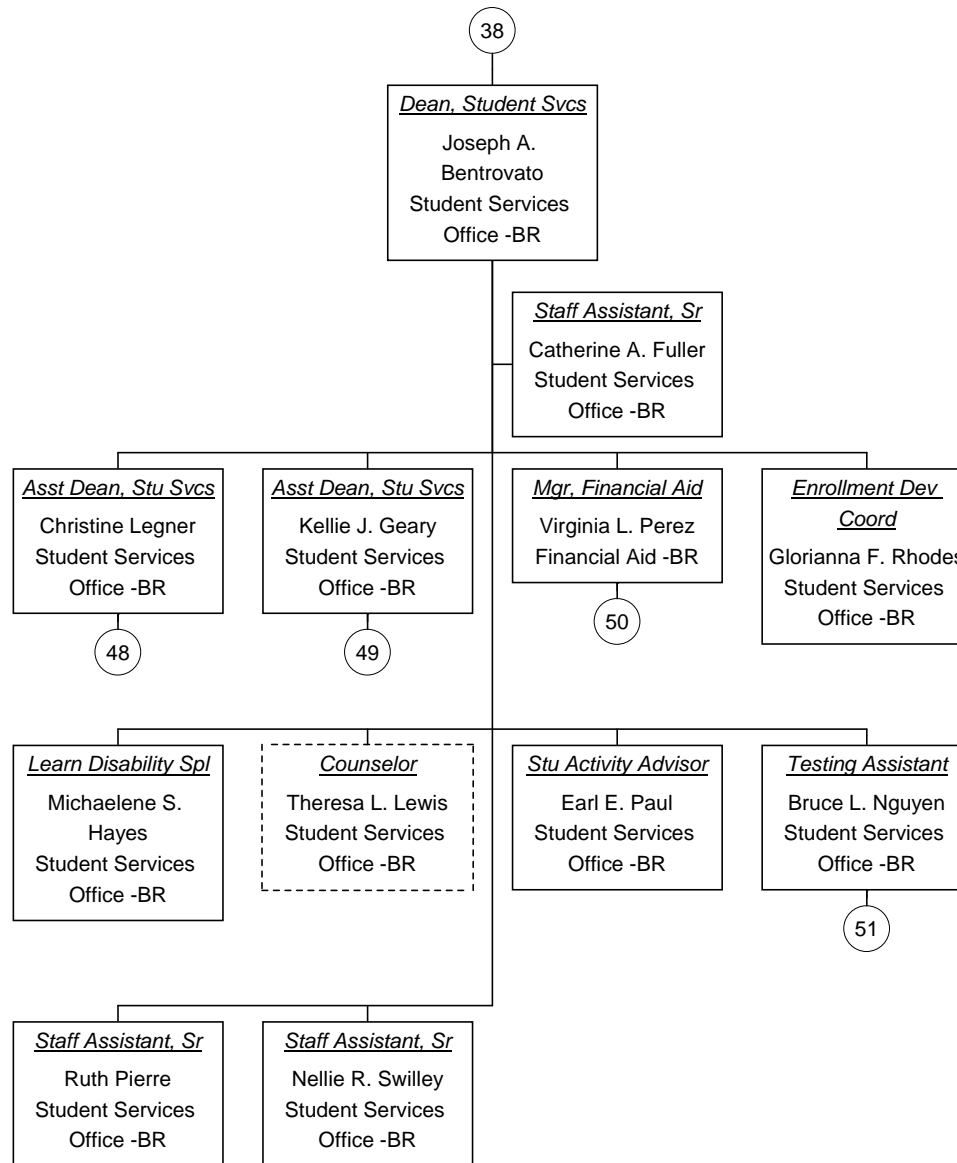

Vacant Position
 Cabinet Position



**Asst Dean, Stu Svcs As of
09/04/2008**

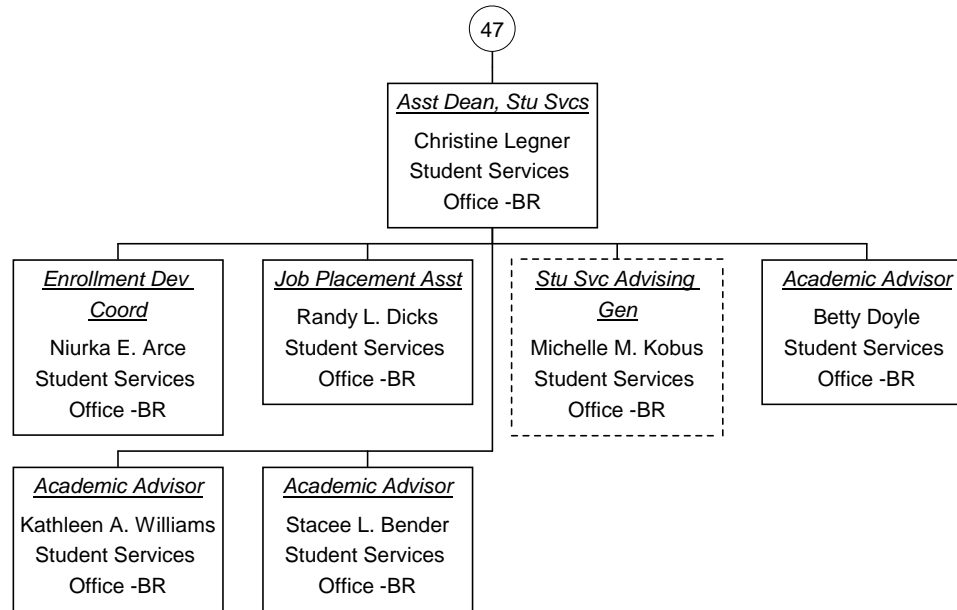

Vacant Position
 Cabinet Position



**Asst Dean, Stu Svcs As of
09/04/2008**

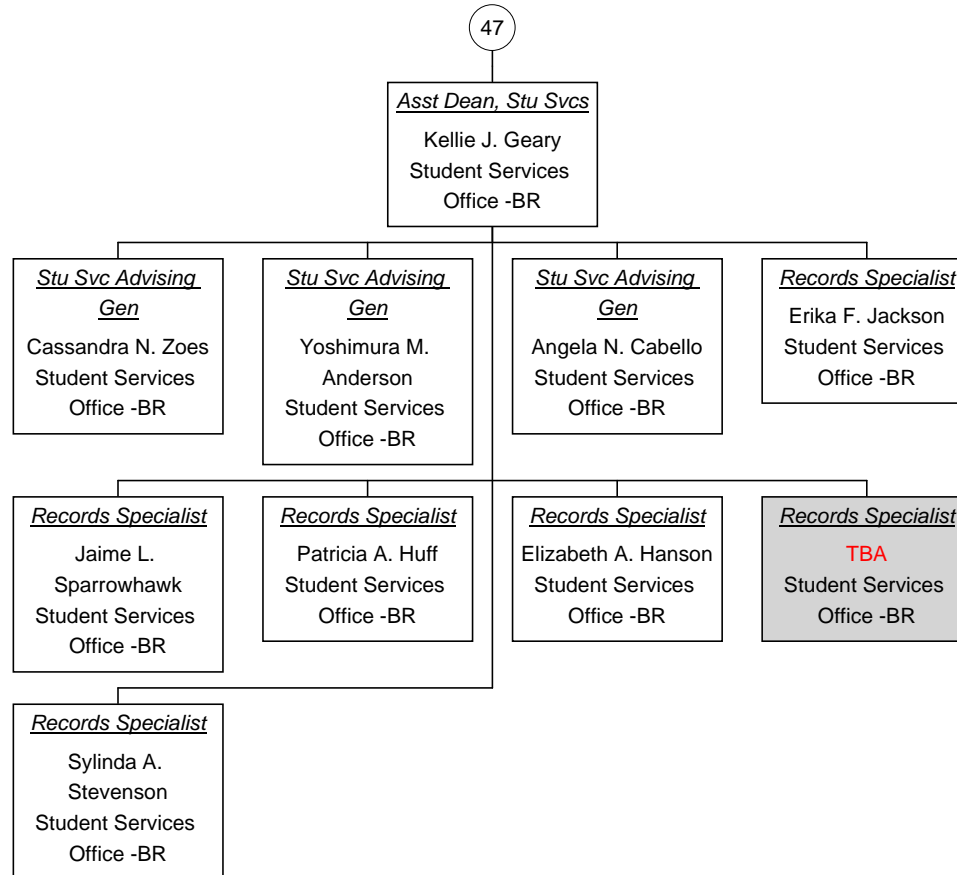

Vacant Position
 Cabinet Position



Mgr, Financial Aid As of 09/04/2008

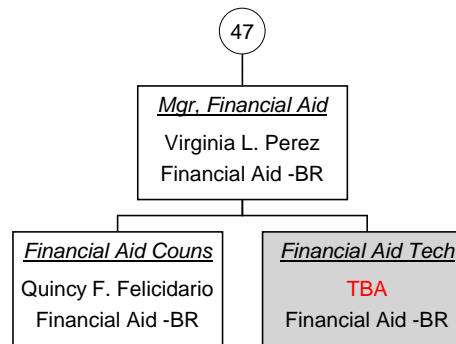

■ Vacant Position
■ Cabinet Position



Testing Assistant As of
09/04/2008

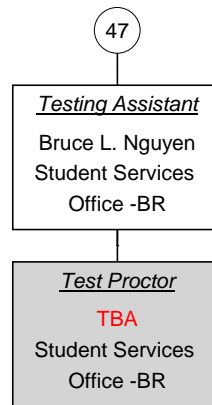

■ Vacant Position
■ Cabinet Position



Mgr, Facilities As of 09/04/2008

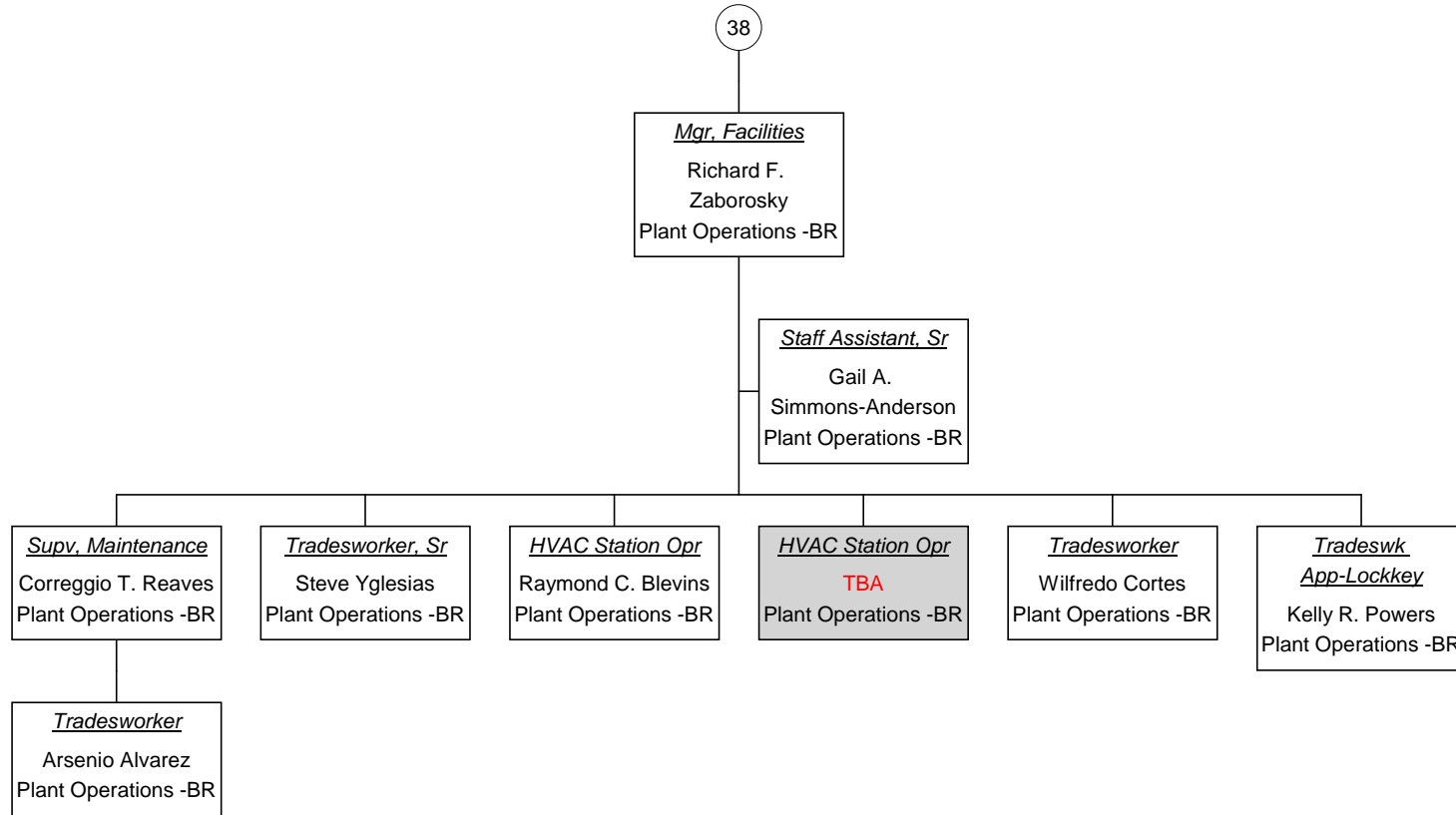

Vacant Position
 Cabinet Position



**Campus President, PC As of
09/04/2008**

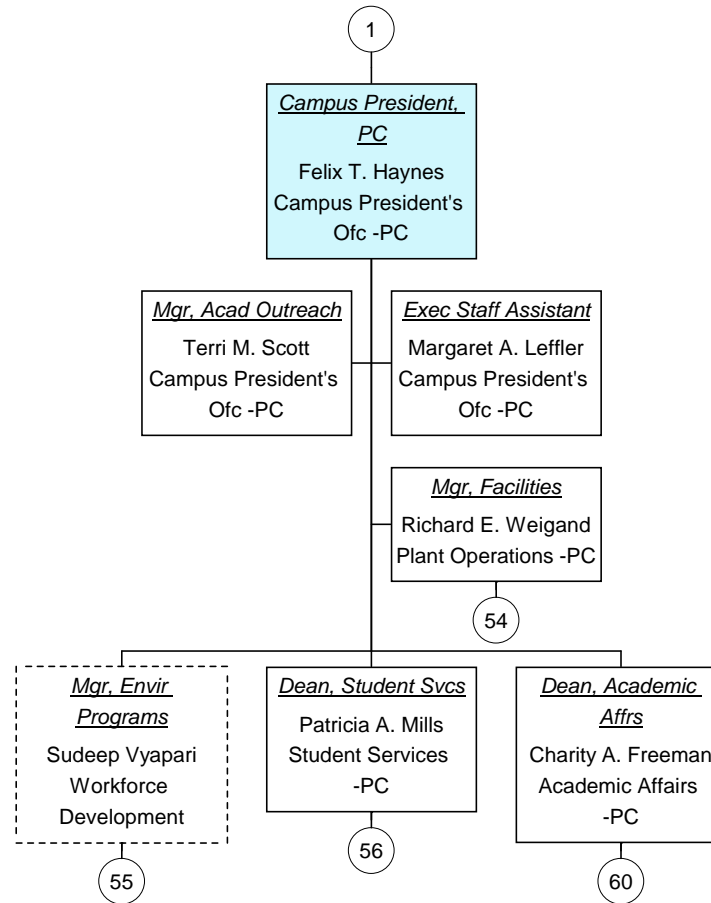

Vacant Position
 Cabinet Position



Mgr, Facilities As of 09/04/2008

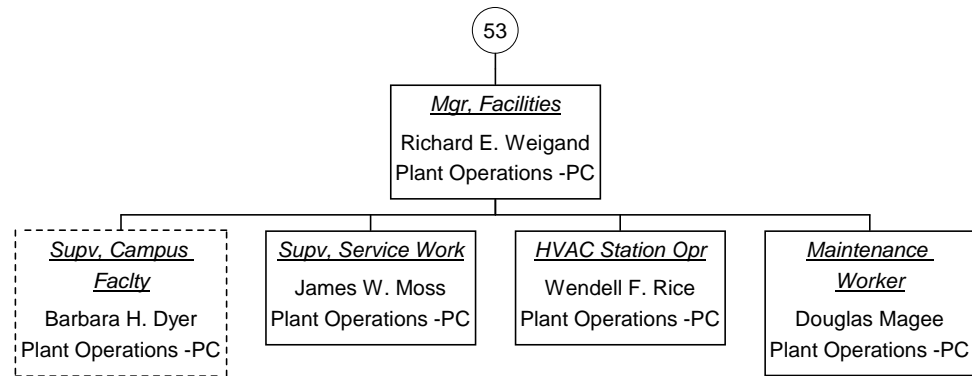

Vacant Position
Cabinet Position



**Mgr, Envir Programs As of
09/04/2008**

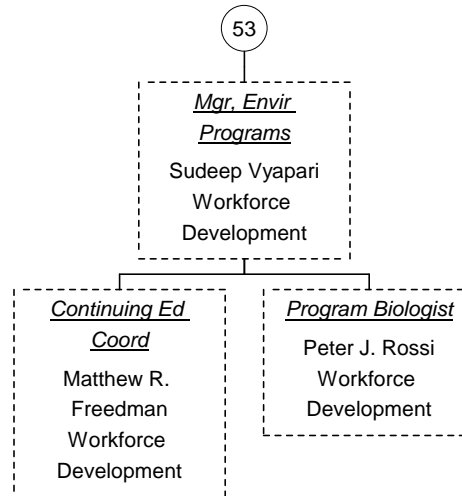

■ Vacant Position
■ Cabinet Position



Dean, Student Svcs As of 09/04/2008

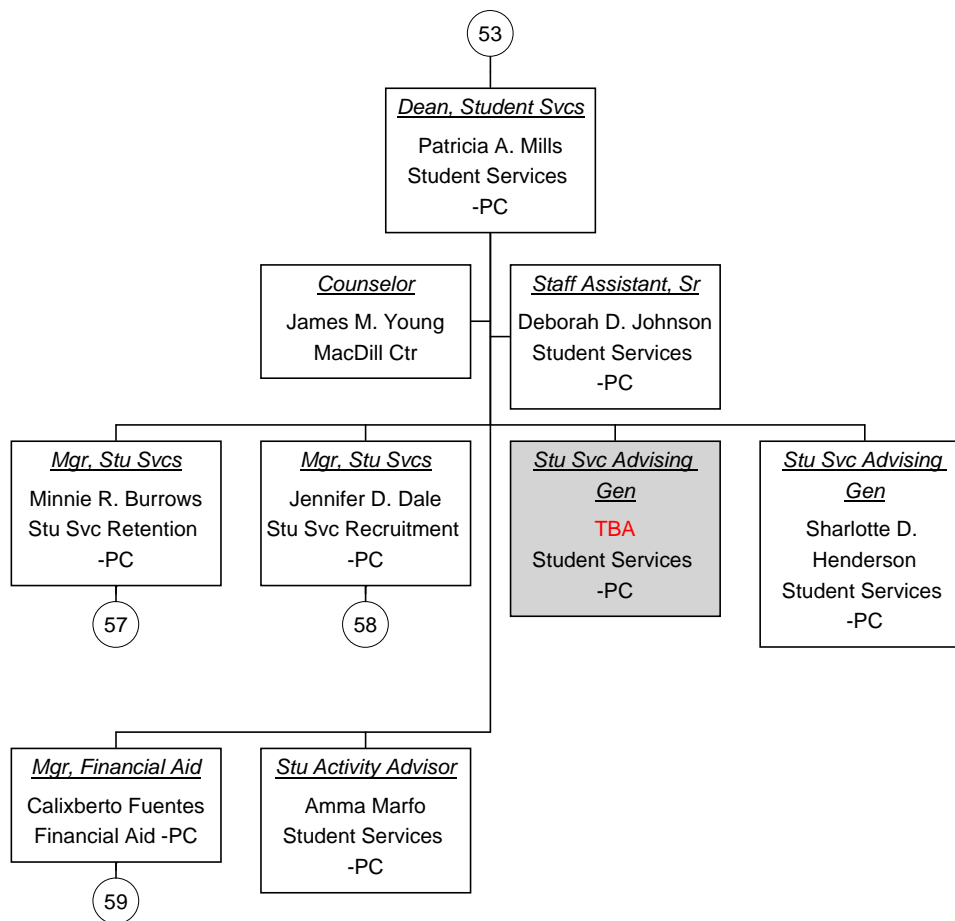

Vacant Position
 Cabinet Position

Mgr, Stu Svcs As of 09/04/2008

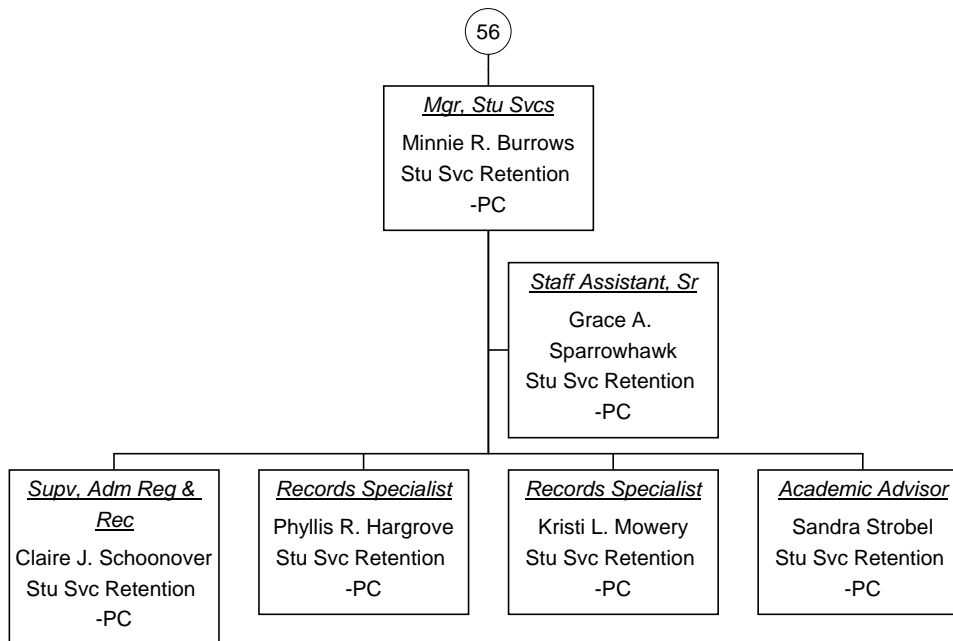

Vacant Position
Cabinet Position



Mgr, Stu Svcs As of 09/04/2008

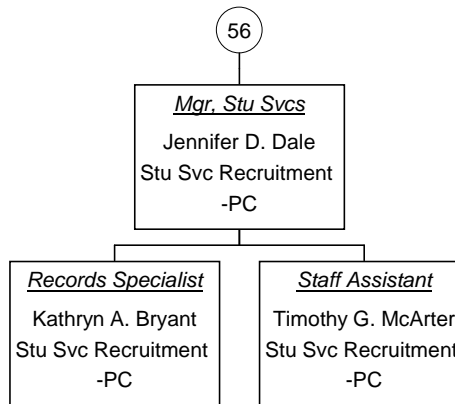

■ Vacant Position
■ Cabinet Position



Mgr, Financial Aid As of 09/04/2008

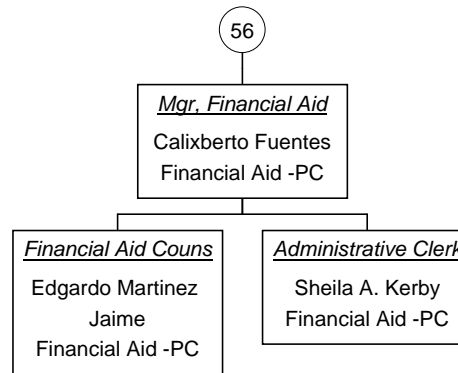

Vacant Position
Cabinet Position

Dean, Academic Affrs As of
09/04/2008

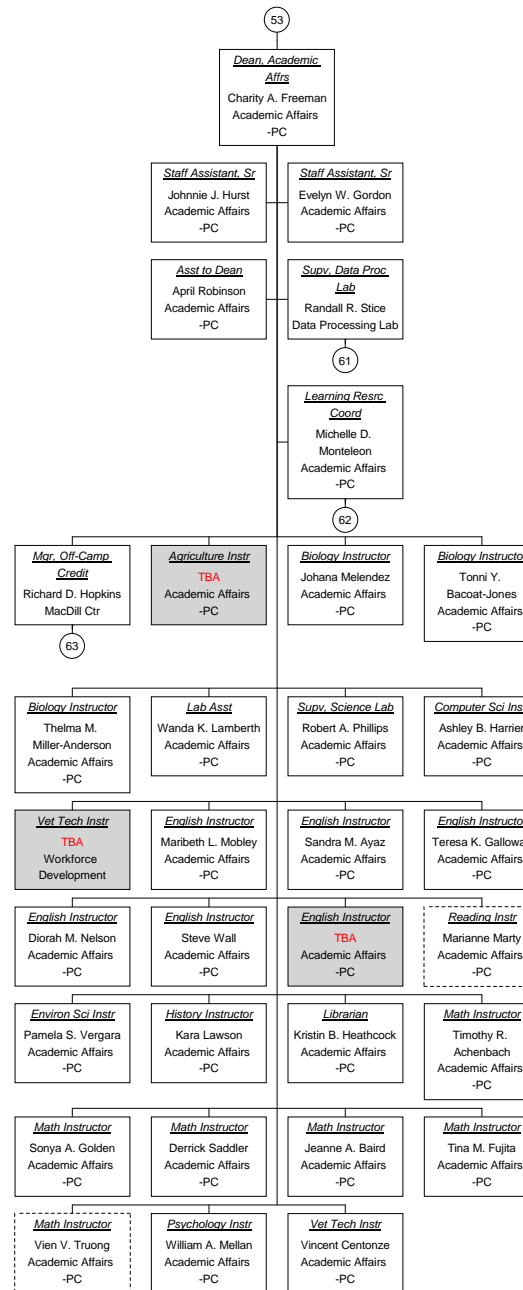

Vacant Position
Cabinet Position
Dotted border = Temp Position



**Supv, Data Proc Lab As of
09/04/2008**

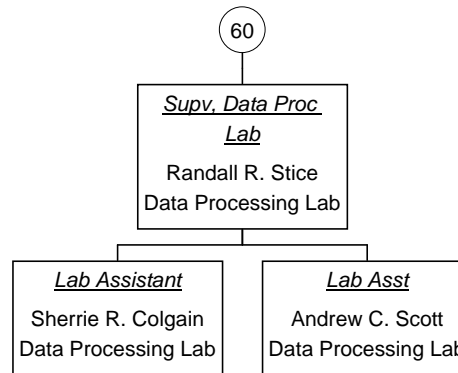

■ Vacant Position
■ Cabinet Position



Learning Resrc Coord As of
09/04/2008

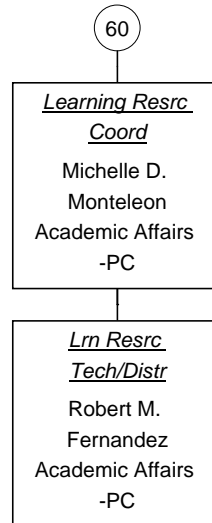

■ Vacant Position
■ Cabinet Position



**Mgr, Off-Camp Credit As of
09/04/2008**

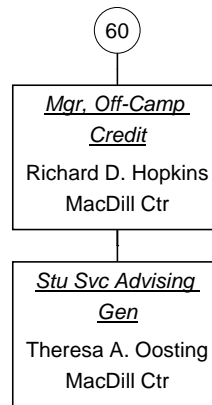

■ Vacant Position
■ Cabinet Position



Campus President, SS As of 09/04/2008

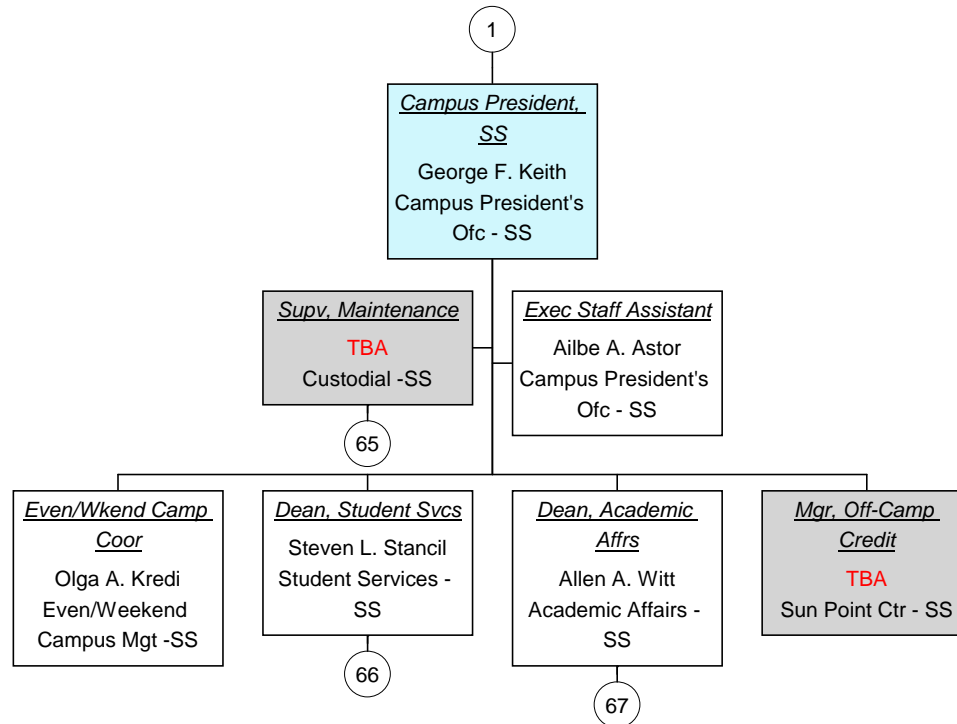

Vacant Position
 Cabinet Position



Supv, Maintenance As of 09/04/2008

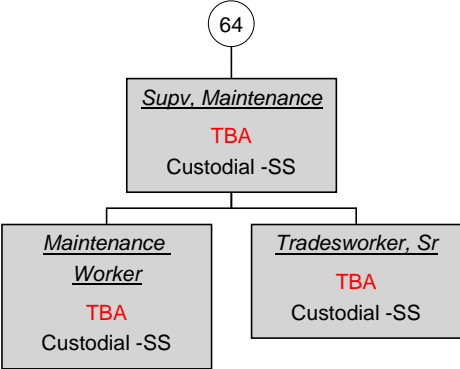

Vacant Position
 Cabinet Position



**Dean, Student Svcs As of
09/04/2008**

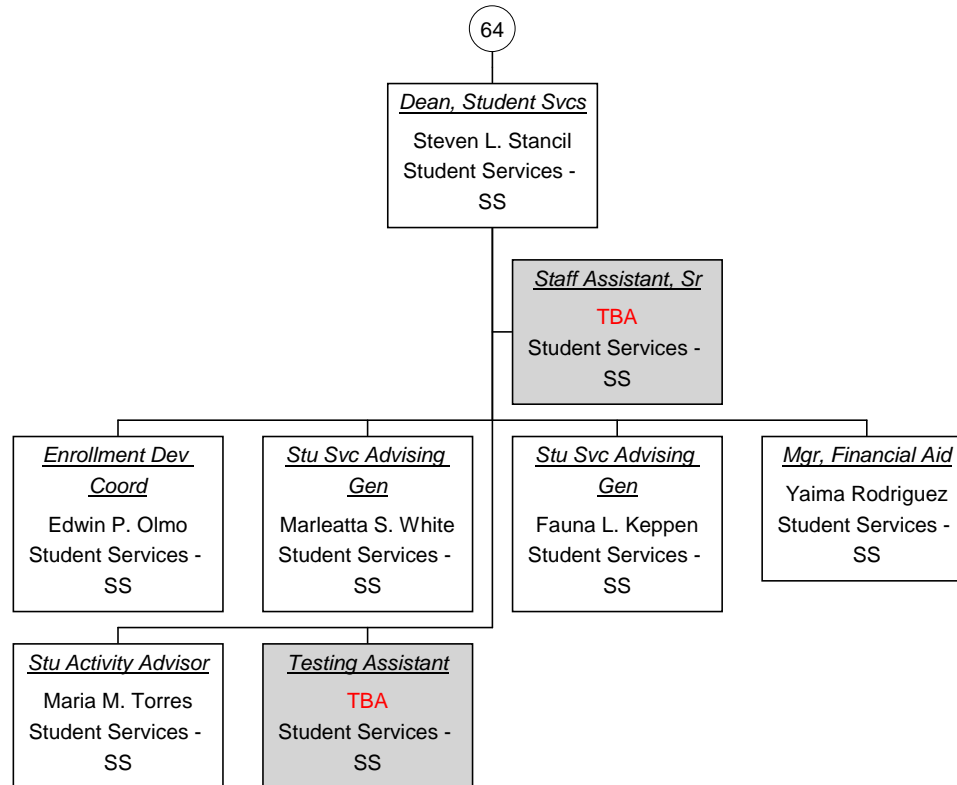

Vacant Position
 Cabinet Position



**Dean, Academic Affrs As of
09/04/2008**

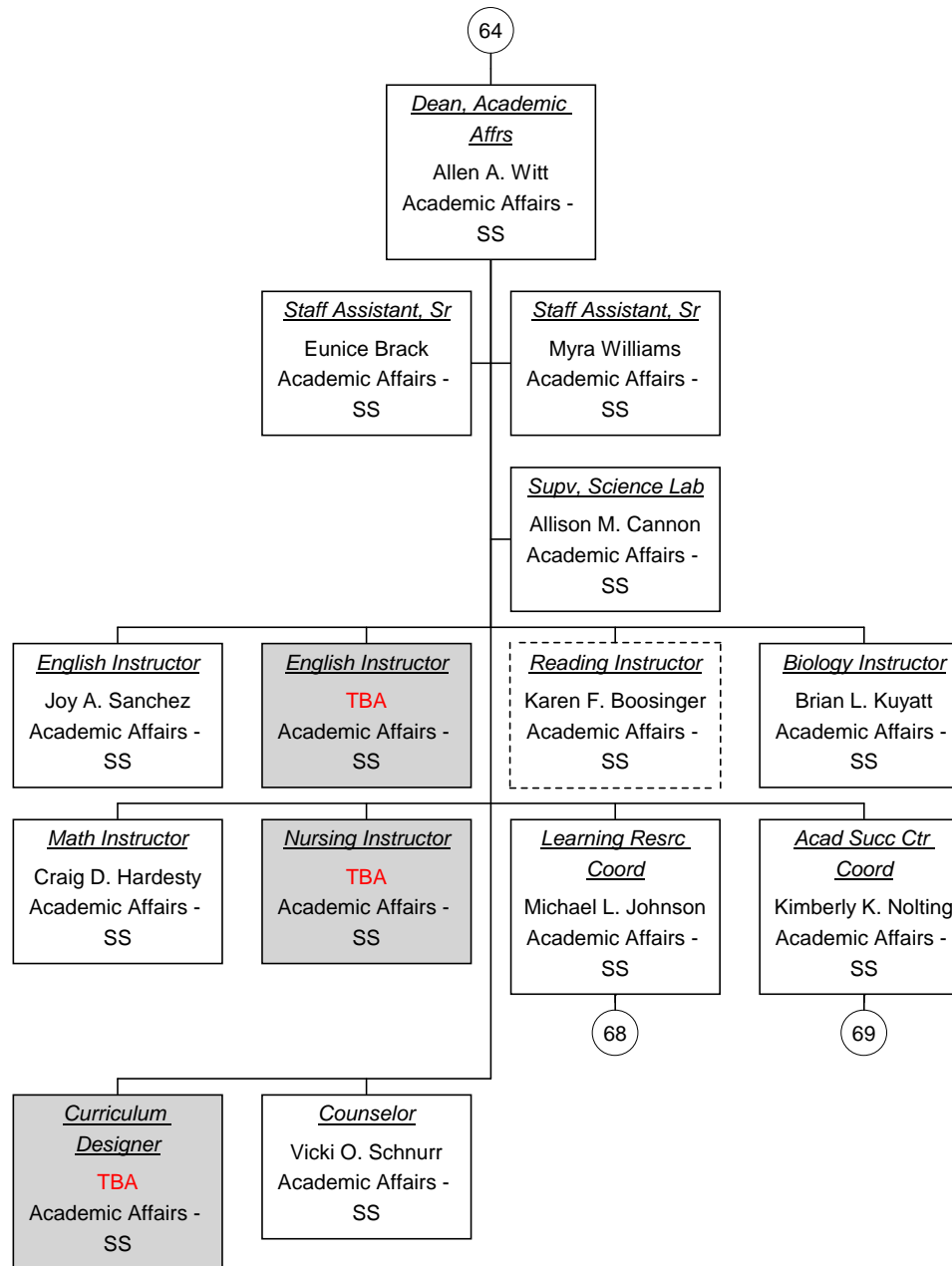

Vacant Position
 Cabinet Position



Learning Resrc Coord As of 09/04/2008

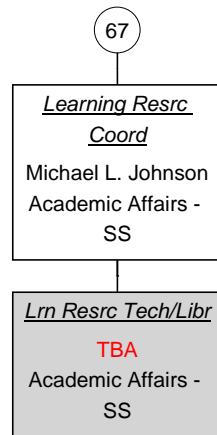

■ Vacant Position
■ Cabinet Position



**Acad Succ Ctr Coord As of
09/04/2008**

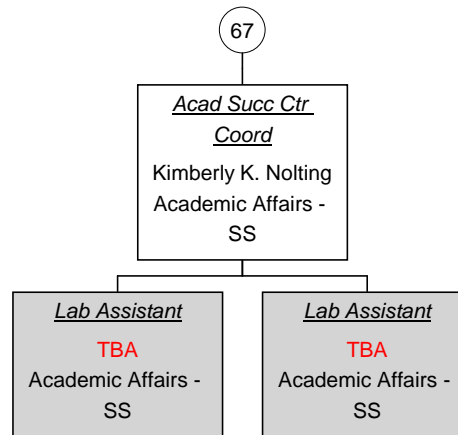

■ Vacant Position
■ Cabinet Position



**VP, Stu Svc Enr Mgt As of
09/04/2008**

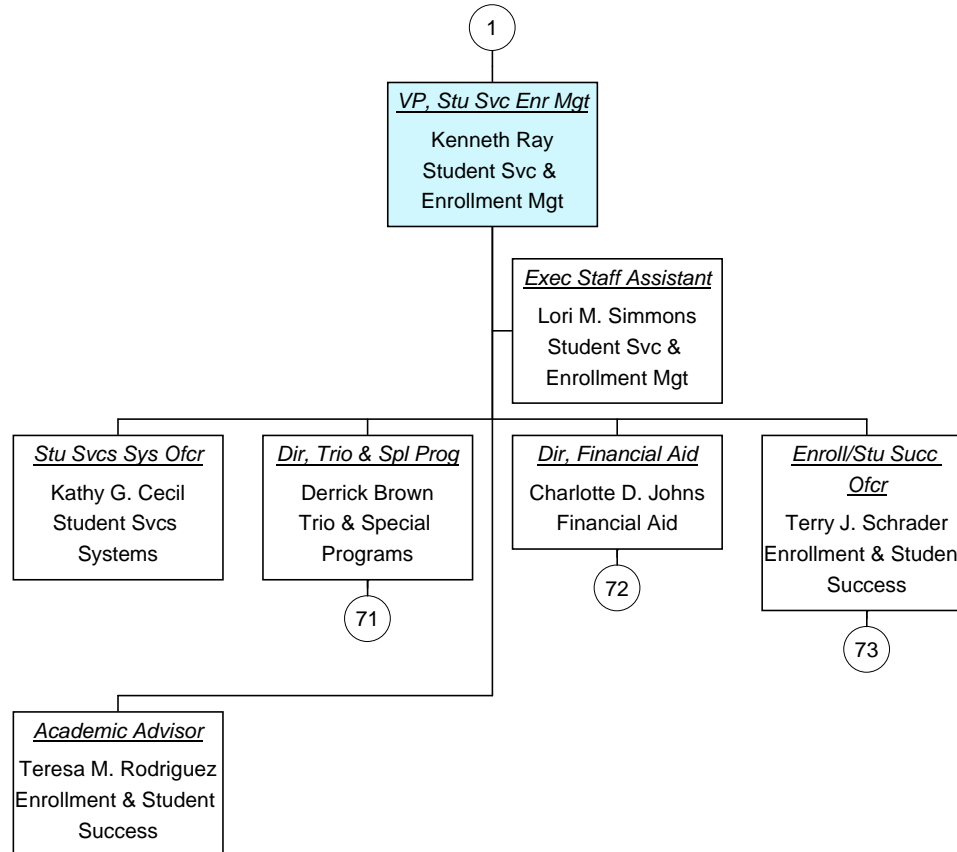

Vacant Position
 Cabinet Position

Dir, Trio & Spl Prog As of 09/04/2008

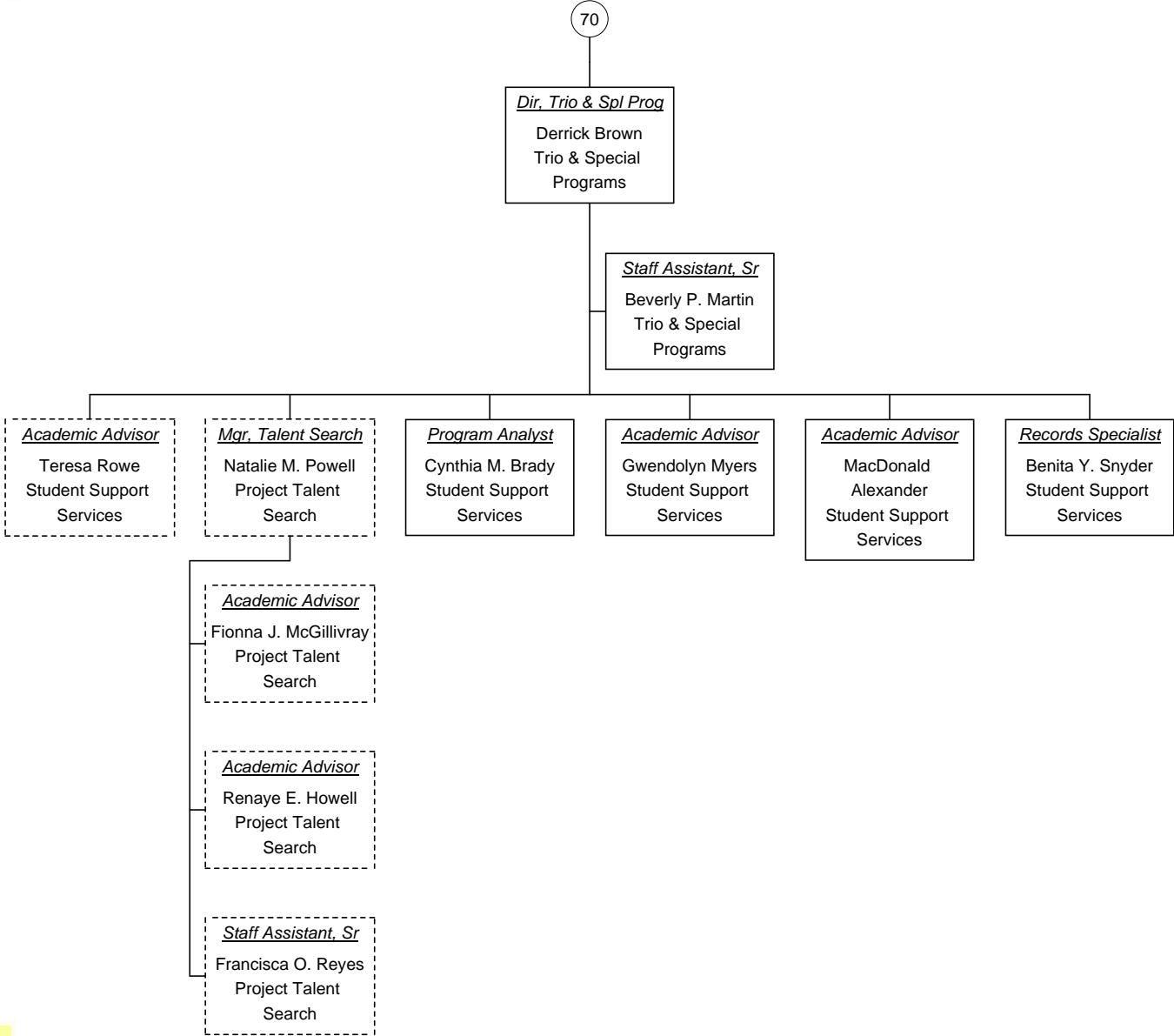

Vacant Position

Cabinet Position



**Dir, Financial Aid As of
09/04/2008**

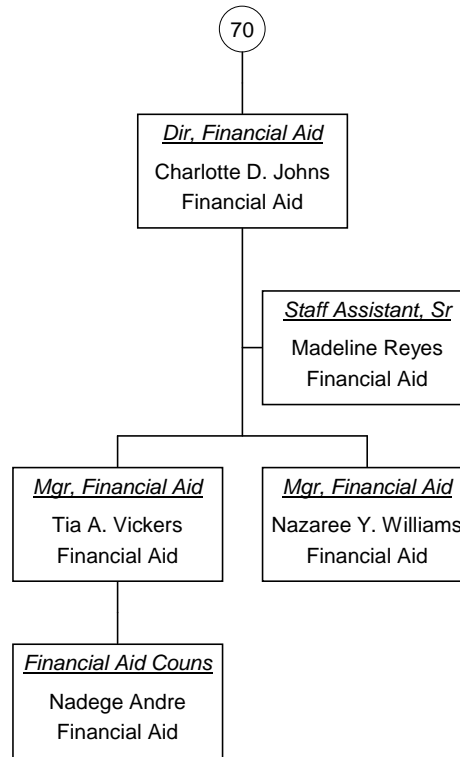

■ Vacant Position
■ Cabinet Position



**Enroll/Stu Succ Ofcr As of
09/04/2008**

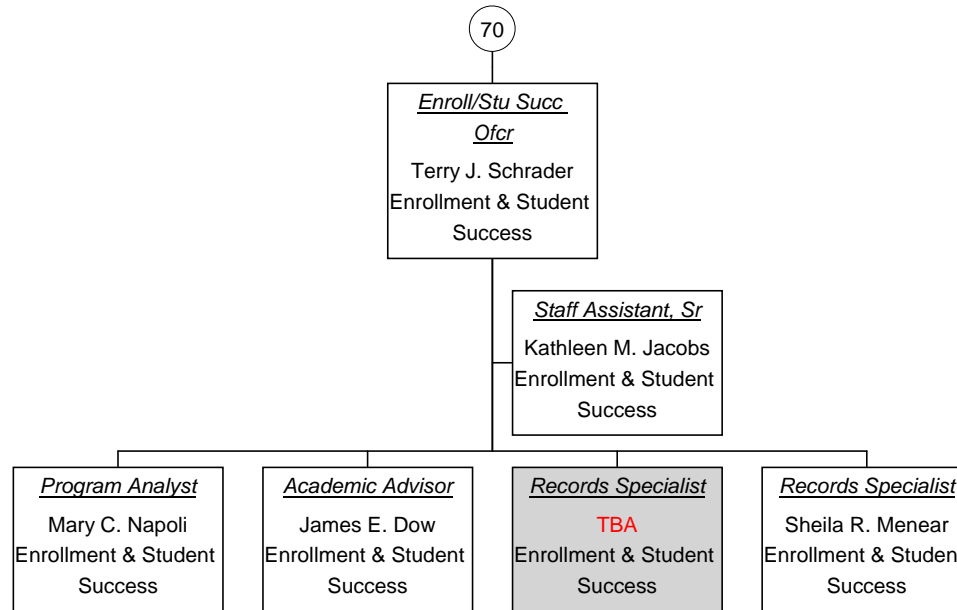

Vacant Position
 Cabinet Position



VP, Acad Affrs As of 09/04/2008

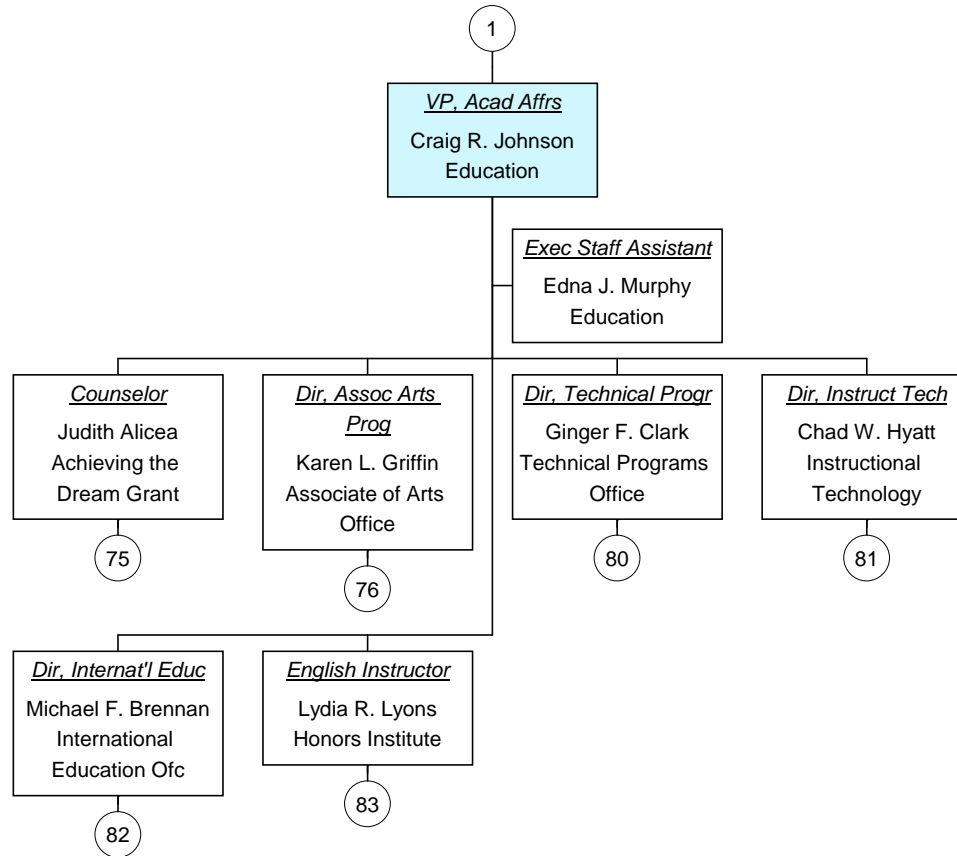

Vacant Position
 Cabinet Position



Counselor As of 09/04/2008

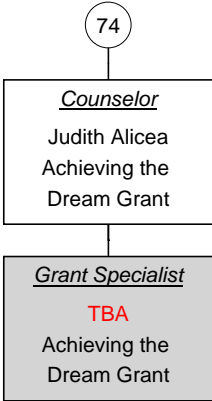

Vacant Position
 Cabinet Position



Dir, Assoc Arts Prog As of 09/04/2008

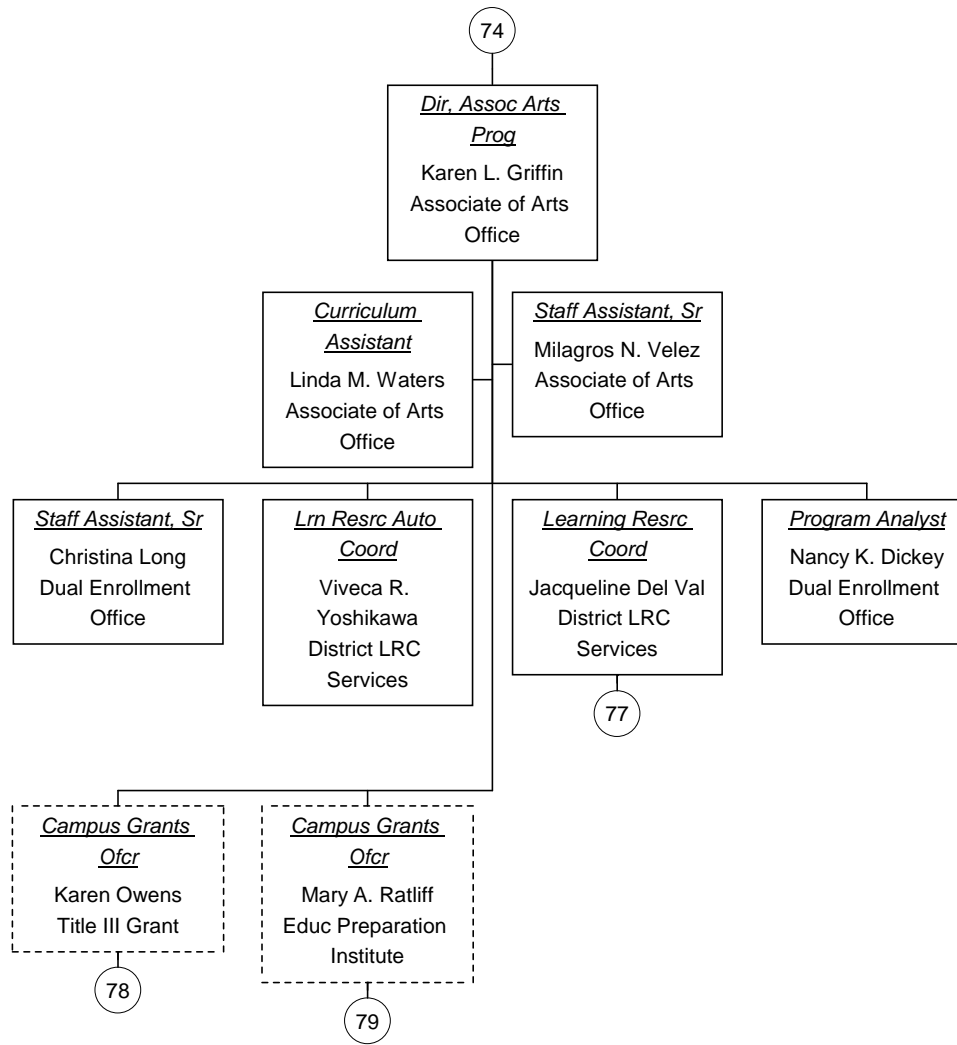

Vacant Position
 Cabinet Position



Learning Resrc Coord As of
09/04/2008

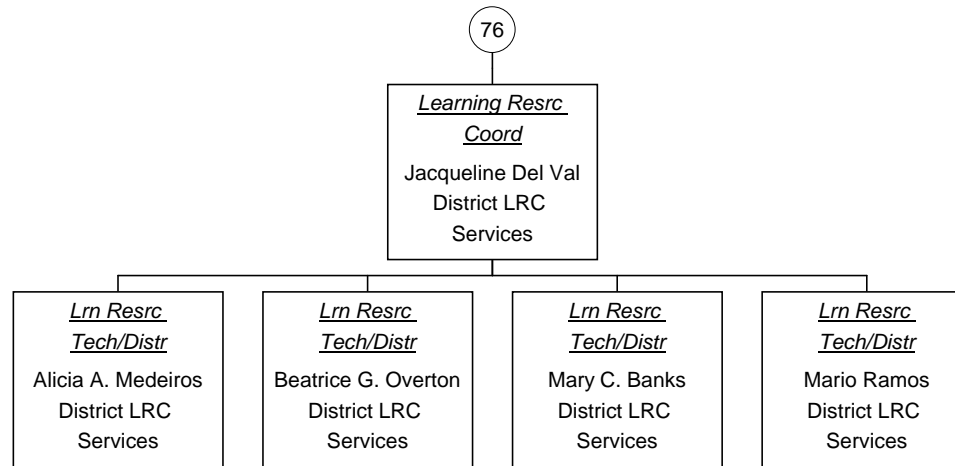

Vacant Position
Cabinet Position



**Campus Grants Ofcr As of
09/04/2008**

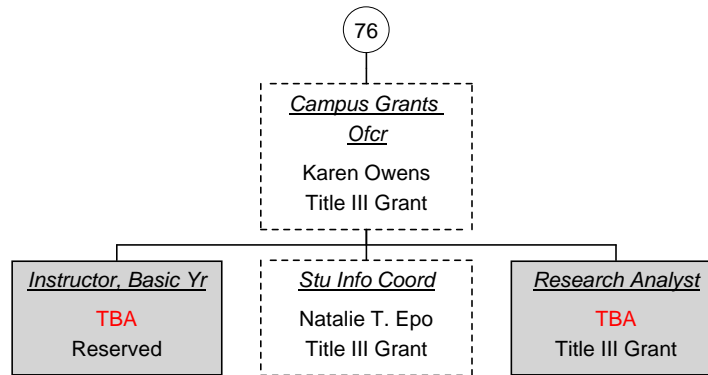

■ Vacant Position
■ Cabinet Position



**Campus Grants Ofcr As of
09/04/2008**

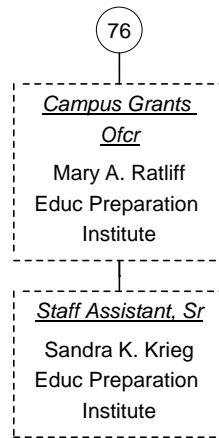

■ Vacant Position
■ Cabinet Position

Dir, Technical Progr As of
09/04/2008

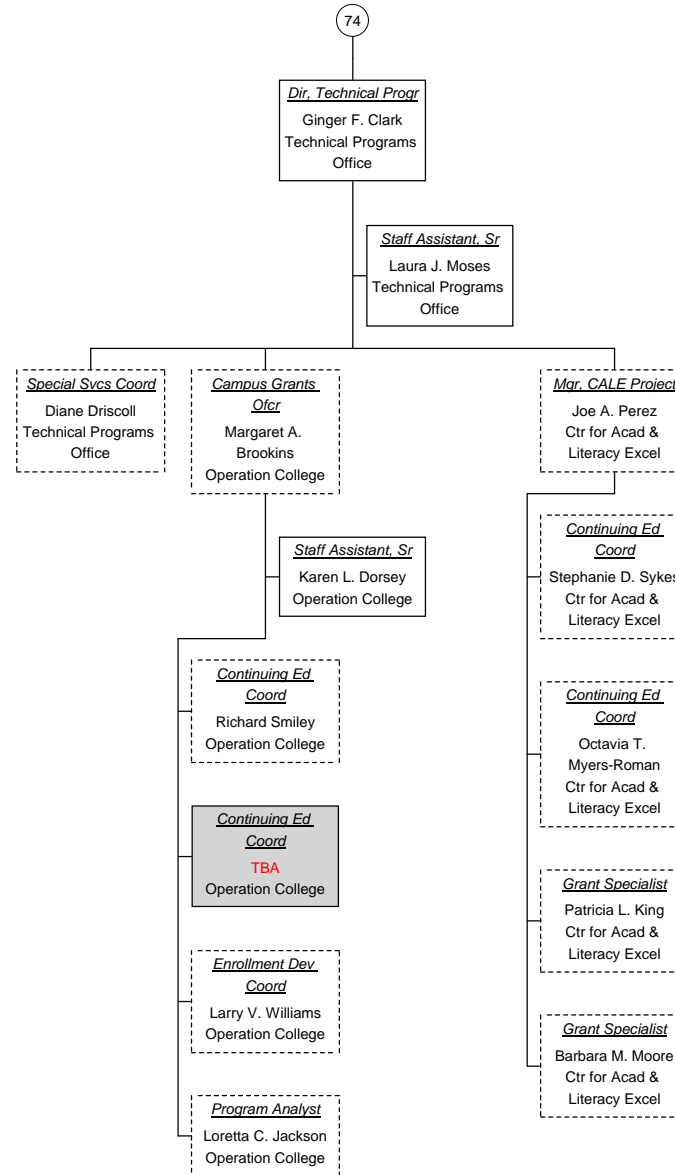

Vacant Position
 Cabinet Position



Dir, Instruct Tech As of 09/04/2008

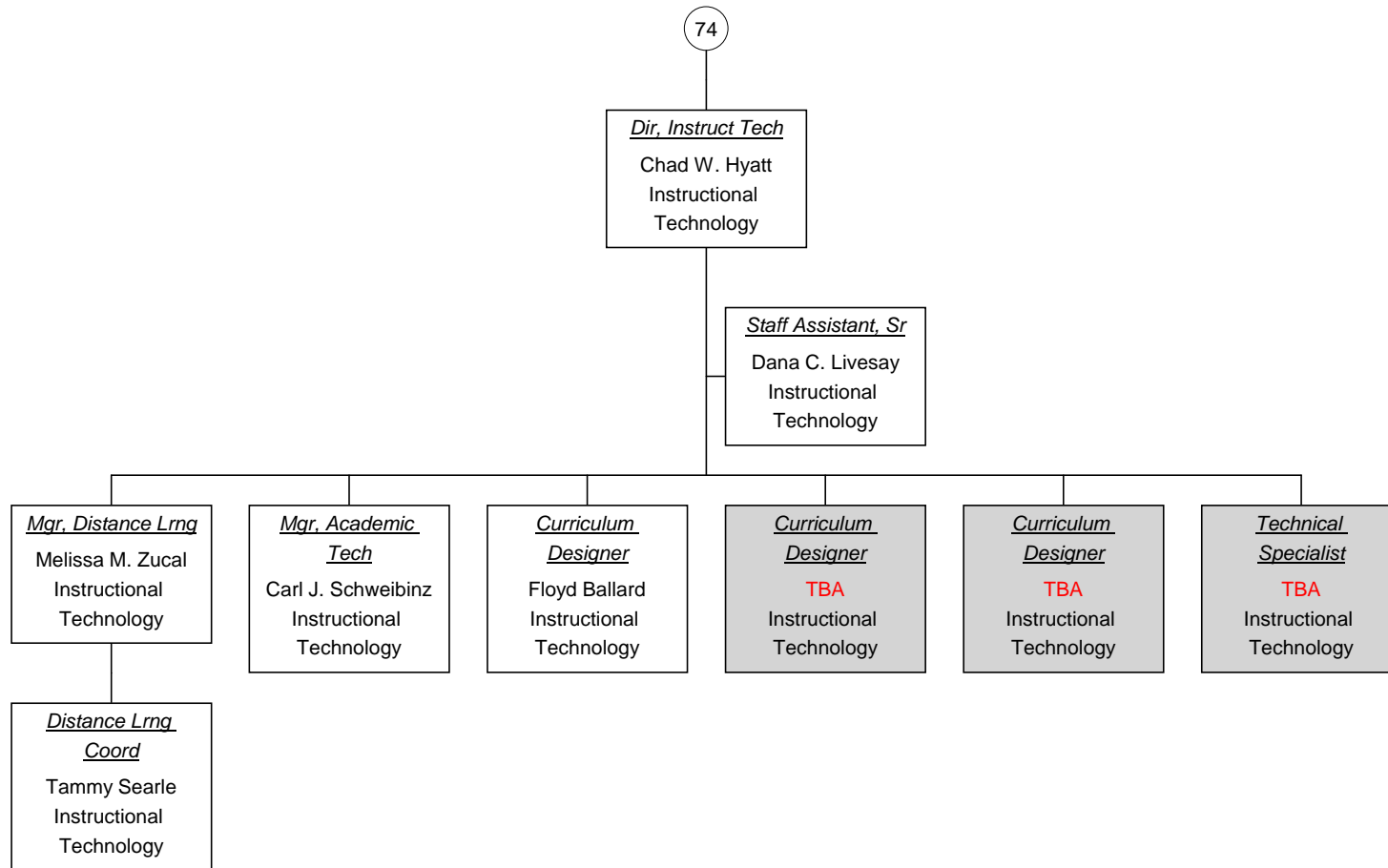

Vacant Position
 Cabinet Position



**Dir, Internat'l Educ As of
09/04/2008**

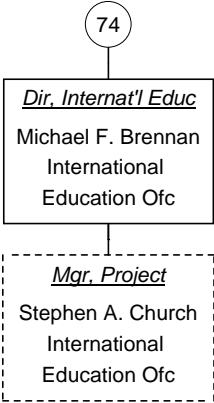

Vacant Position
 Cabinet Position



English Instructor As of 09/04/2008

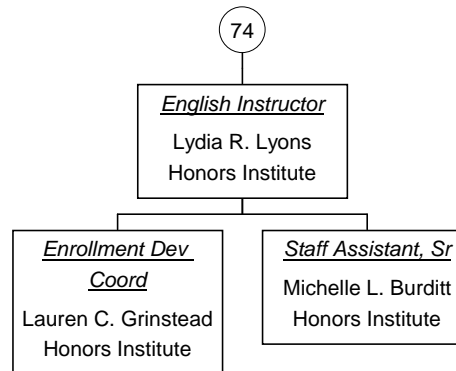

■ Vacant Position
■ Cabinet Position



**VP, Admin / CFO As of
09/04/2008**

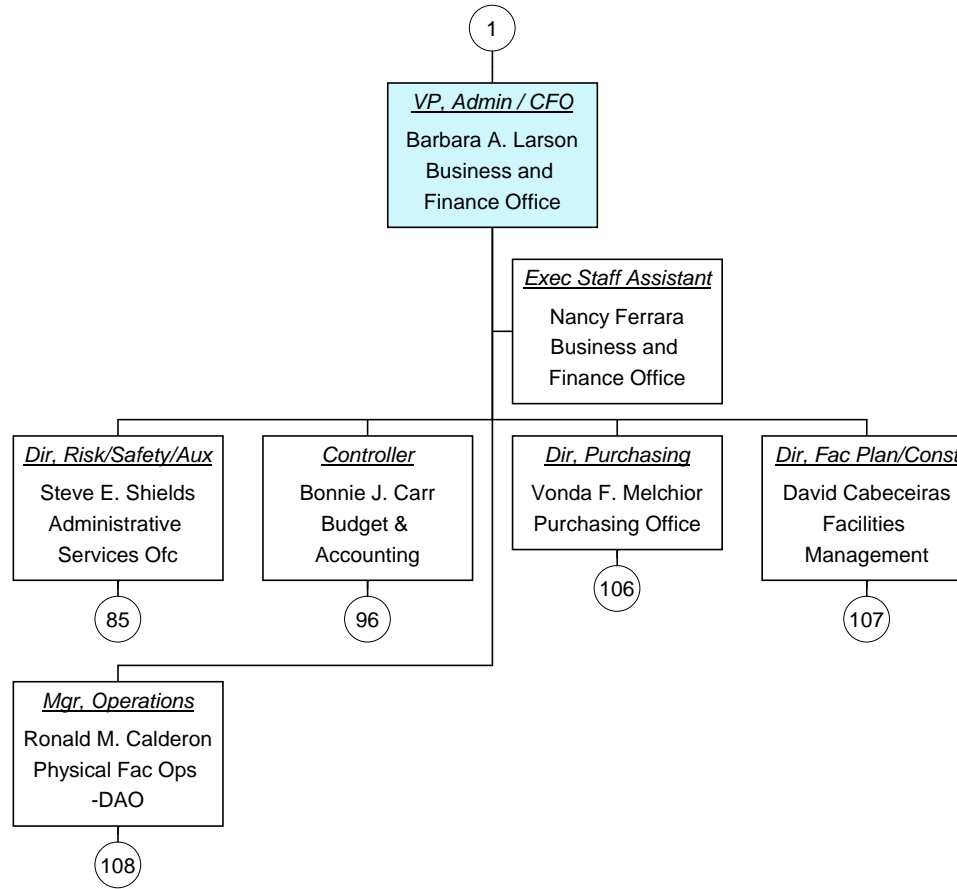

Vacant Position
 Cabinet Position

**Dir, Risk/Safety/Aux As of
09/04/2008**

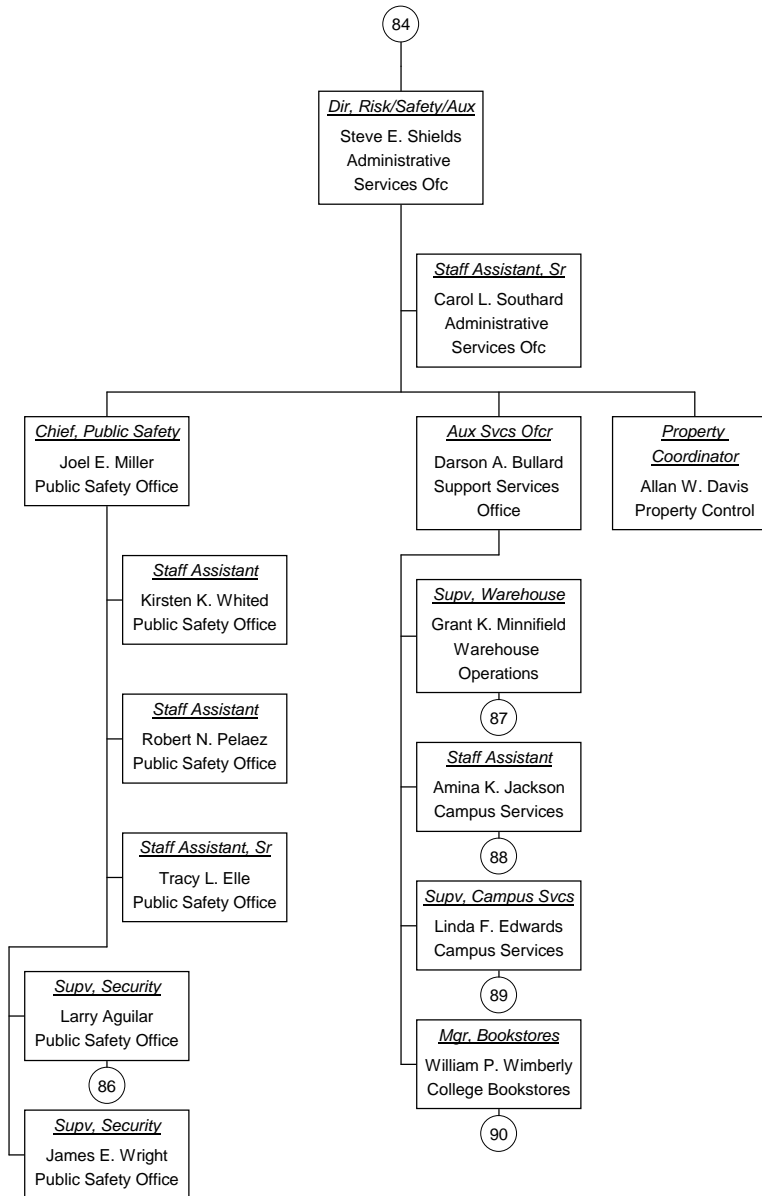

Vacant Position
 Cabinet Position

Supv, Security As of 09/04/2008

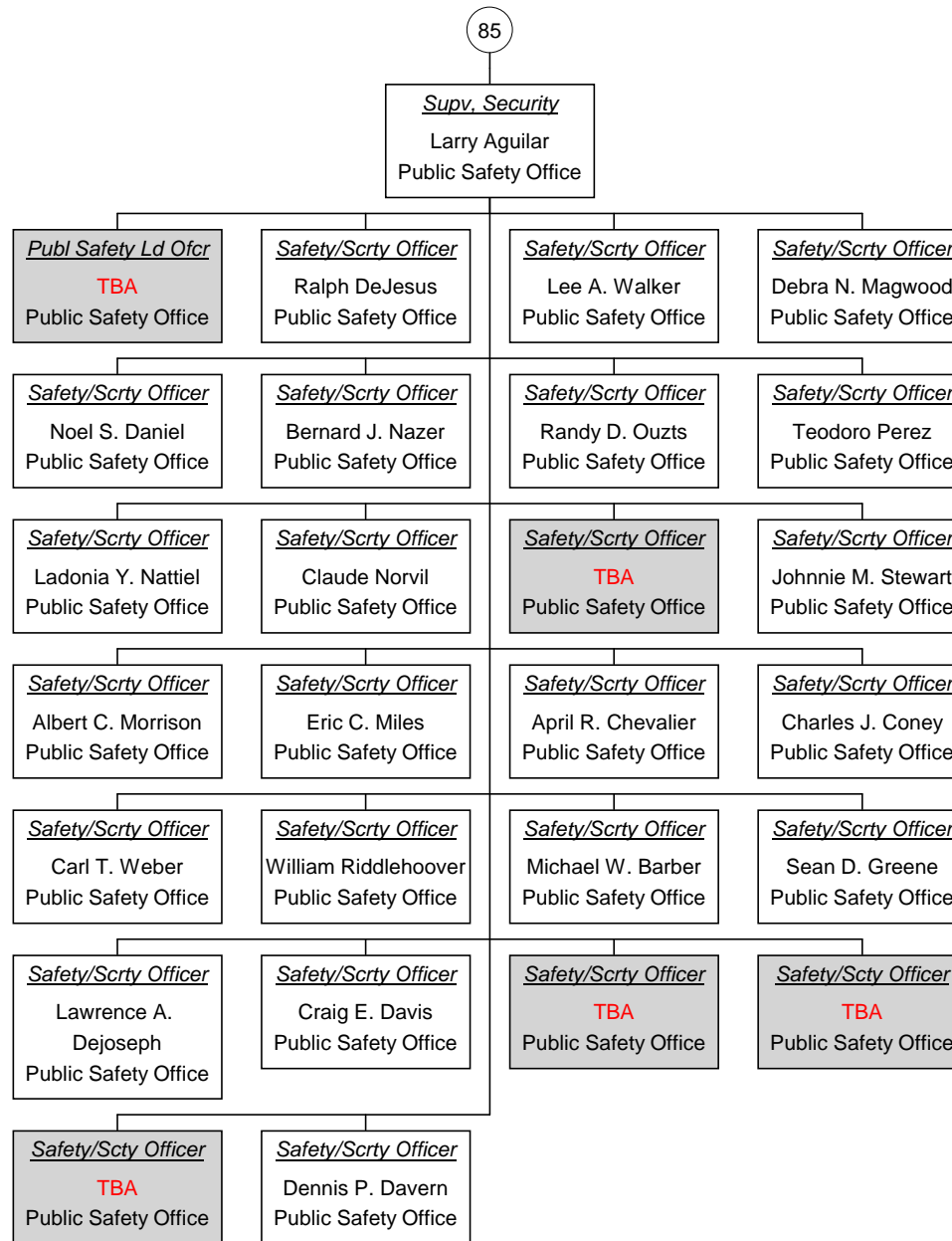

Vacant Position
 Cabinet Position



**Supv, Warehouse As of
09/04/2008**

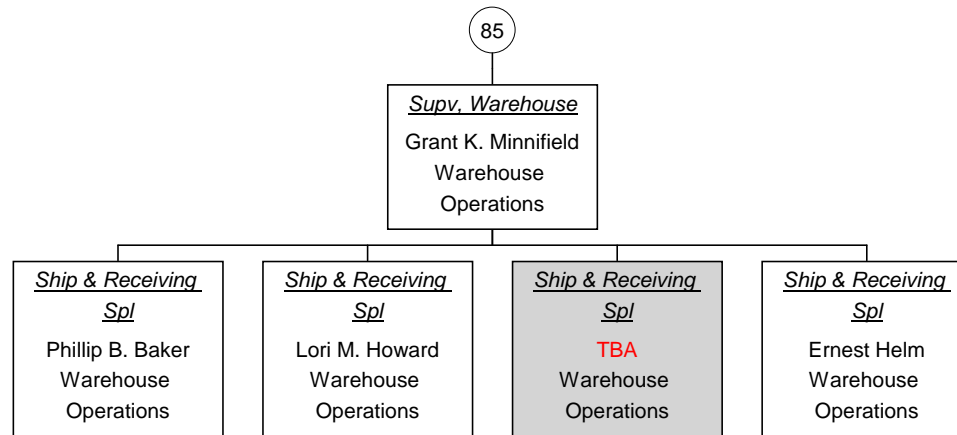

■ Vacant Position
■ Cabinet Position



Staff Assistant As of 09/04/2008

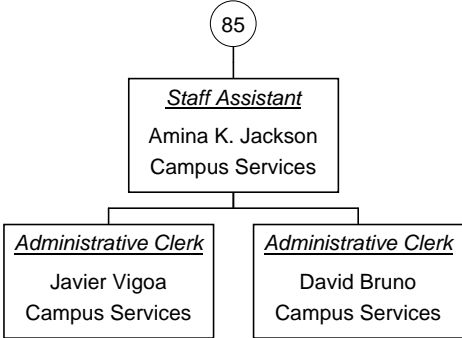

Vacant Position
 Cabinet Position



**Supv, Campus Svcs As of
09/04/2008**

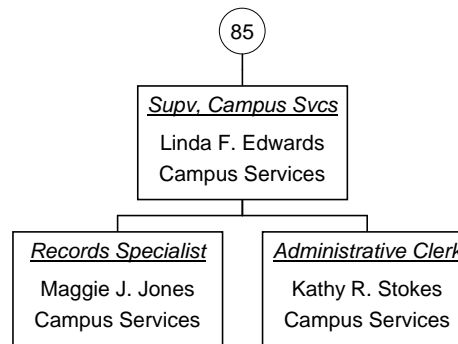

■ Vacant Position
■ Cabinet Position



**Mgr, Bookstores As of
09/04/2008**

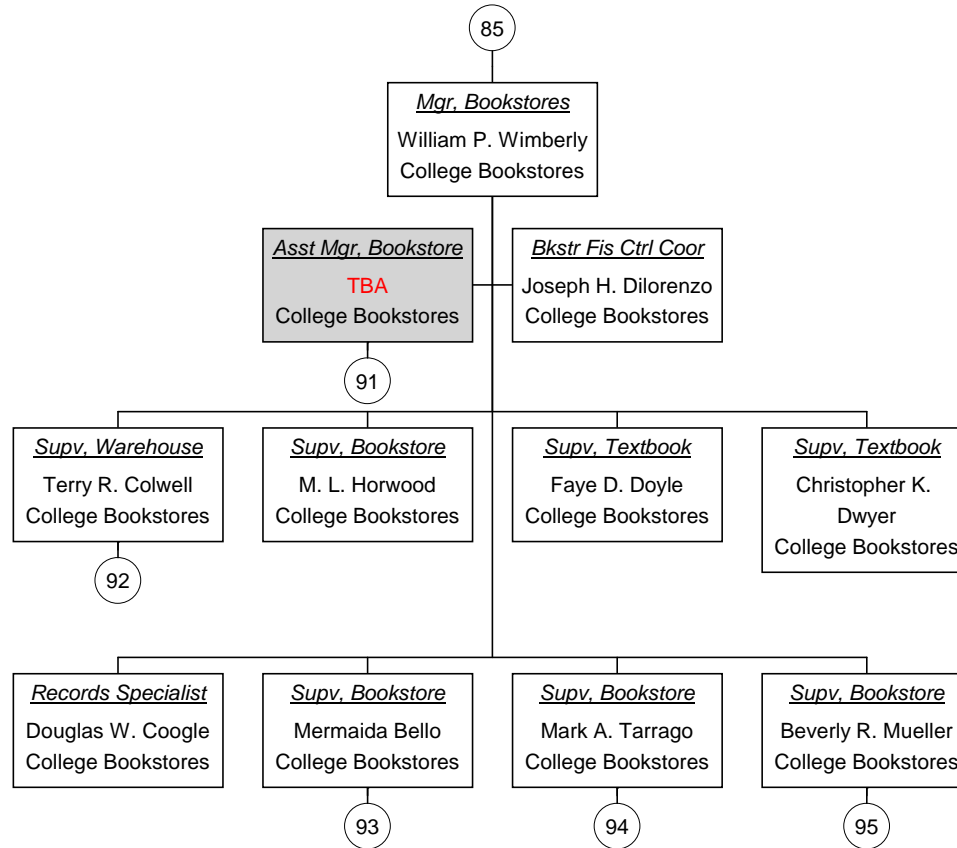

Vacant Position
 Cabinet Position



**Asst Mgr, Bookstore As of
09/04/2008**

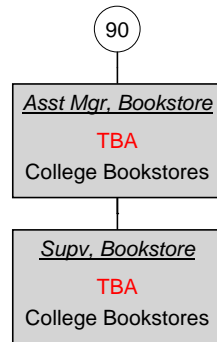

■ Vacant Position
■ Cabinet Position



**Supv, Warehouse As of
09/04/2008**

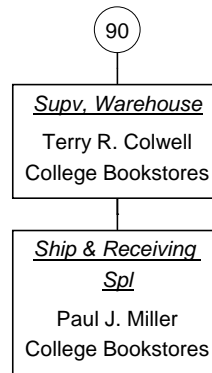

■ Vacant Position
■ Cabinet Position



**Supv, Bookstore As of
09/04/2008**

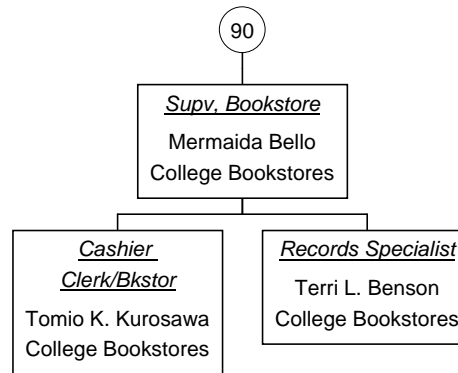

■ Vacant Position
■ Cabinet Position



**Supv, Bookstore As of
09/04/2008**

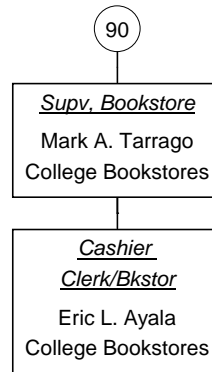

■ Vacant Position
■ Cabinet Position



**Supv, Bookstore As of
09/04/2008**

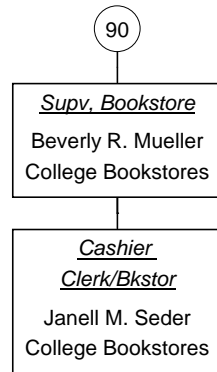

■ Vacant Position
■ Cabinet Position



Controller As of 09/04/2008

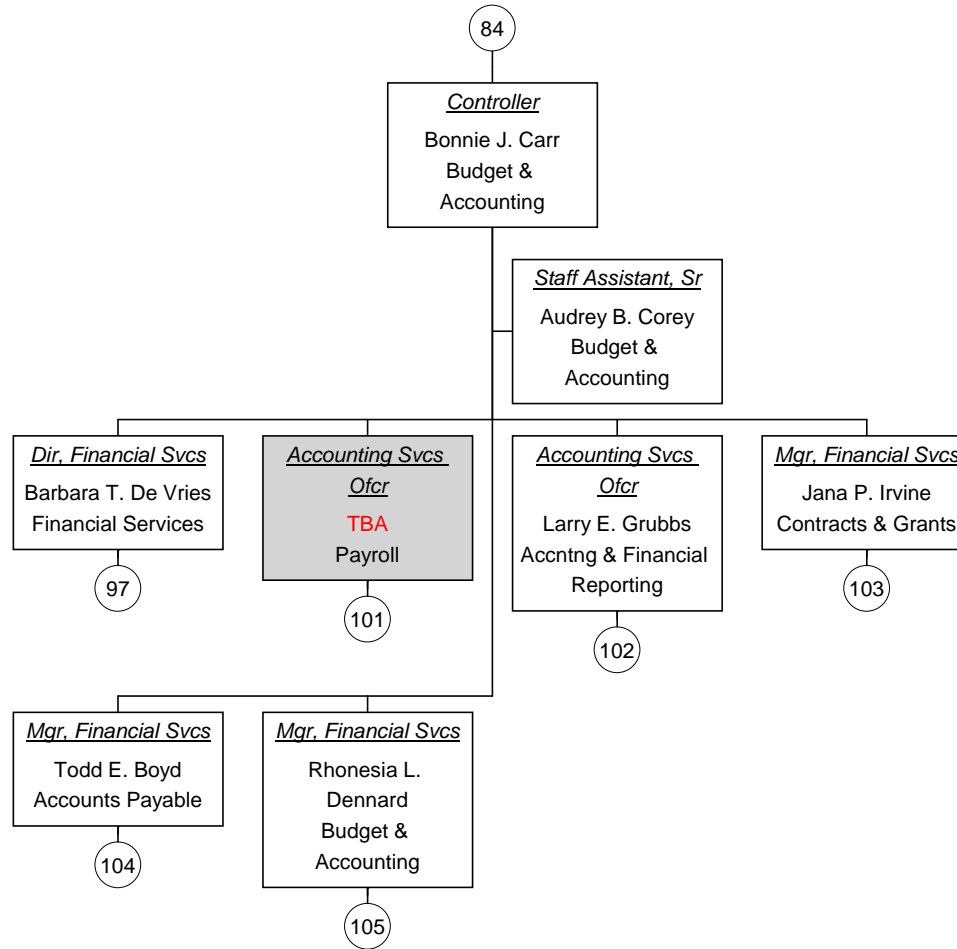

Vacant Position
 Cabinet Position



Dir, Financial Svcs As of 09/04/2008

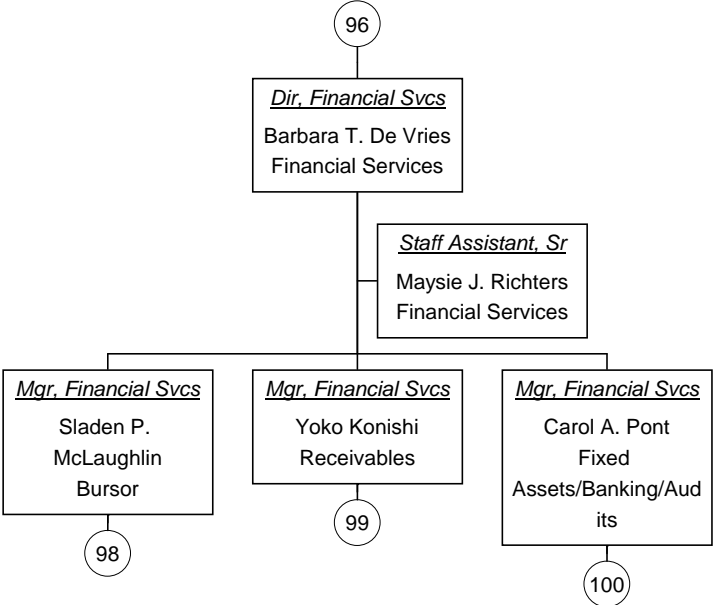

Vacant Position
 Cabinet Position



**Mgr, Financial Svcs As of
09/04/2008**

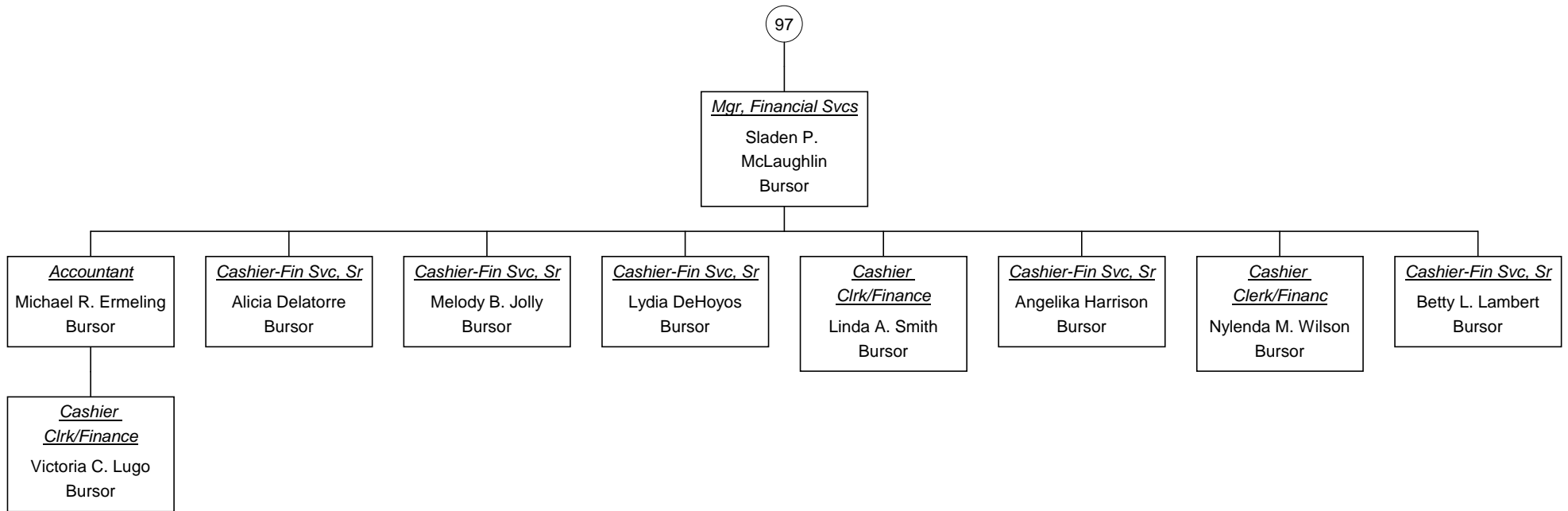

Vacant Position
 Cabinet Position



**Mgr, Financial Svcs As of
09/04/2008**

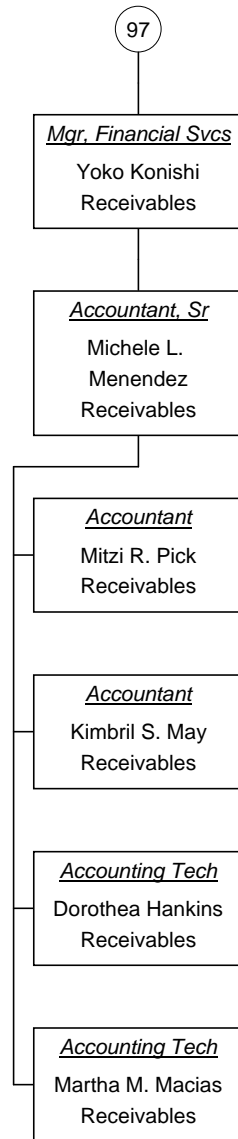

■ Vacant Position
■ Cabinet Position



**Mgr, Financial Svcs As of
09/04/2008**

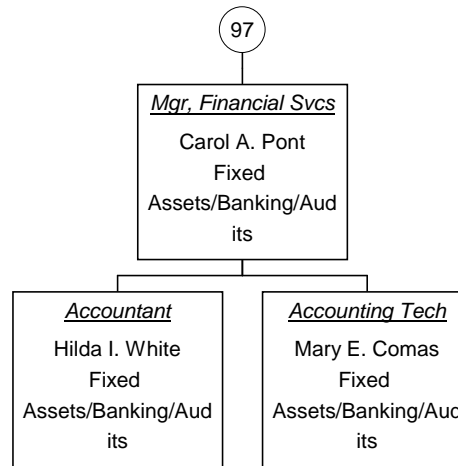

■ Vacant Position
■ Cabinet Position



Accounting Svcs Ofcr As of
09/04/2008

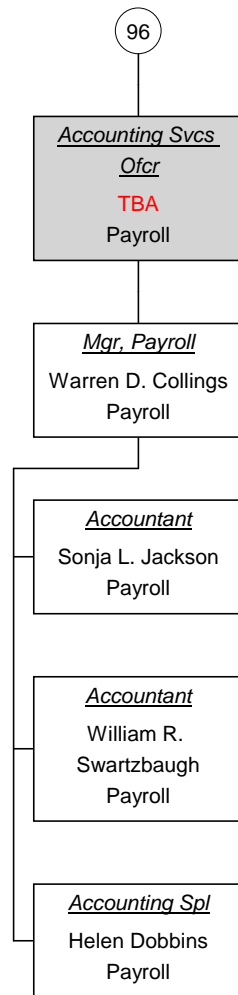

Vacant Position
Cabinet Position



**Accounting Svcs Ofcr As of
09/04/2008**

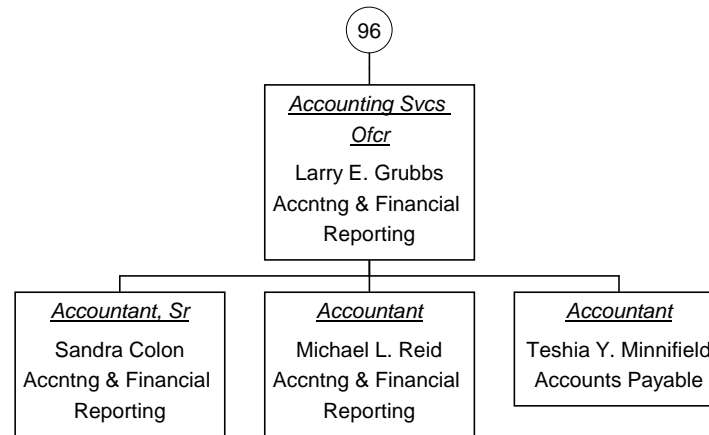

■ Vacant Position
■ Cabinet Position



**Mgr, Financial Svcs As of
09/04/2008**

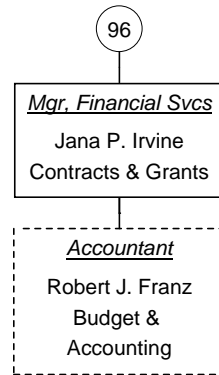

Vacant Position
Cabinet Position



**Mgr, Financial Svcs As of
09/04/2008**

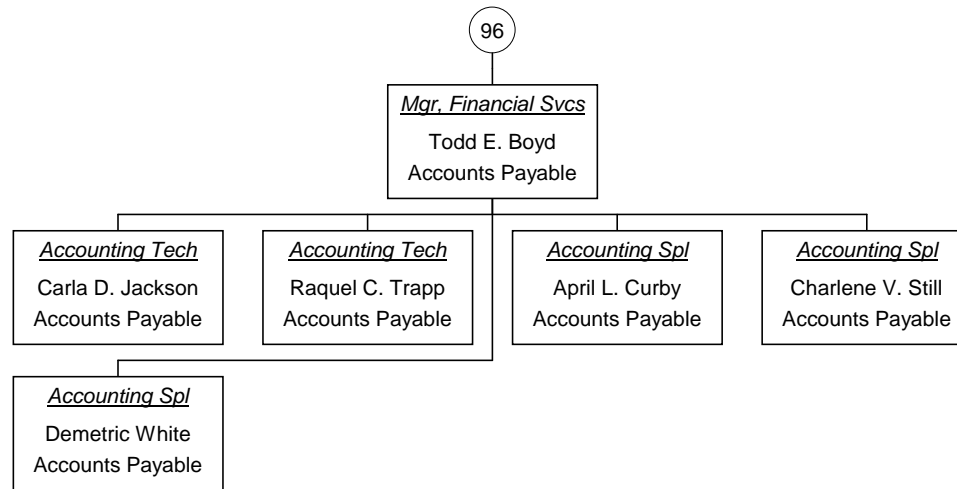

Vacant Position
Cabinet Position



**Mgr, Financial Svcs As of
09/04/2008**

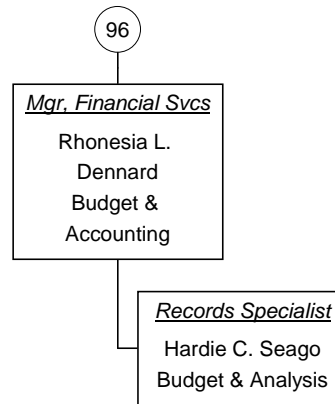

■ Vacant Position
■ Cabinet Position



**Dir, Purchasing As of
09/04/2008**

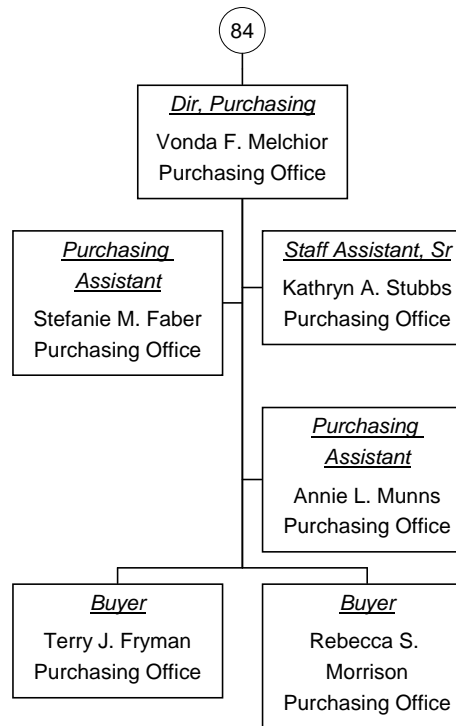

■ Vacant Position
■ Cabinet Position



Dir, Fac Plan/Const As of
09/04/2008

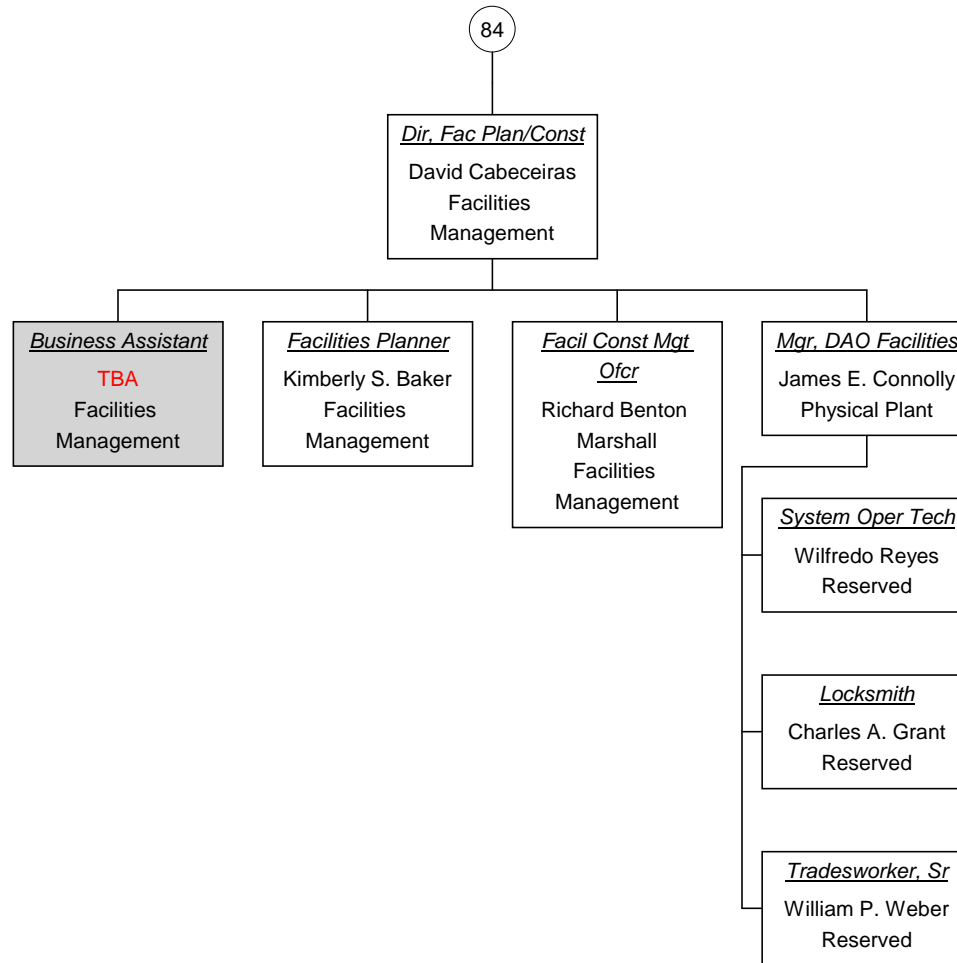

Vacant Position
Cabinet Position

Mgr, Operations As of
09/04/2008

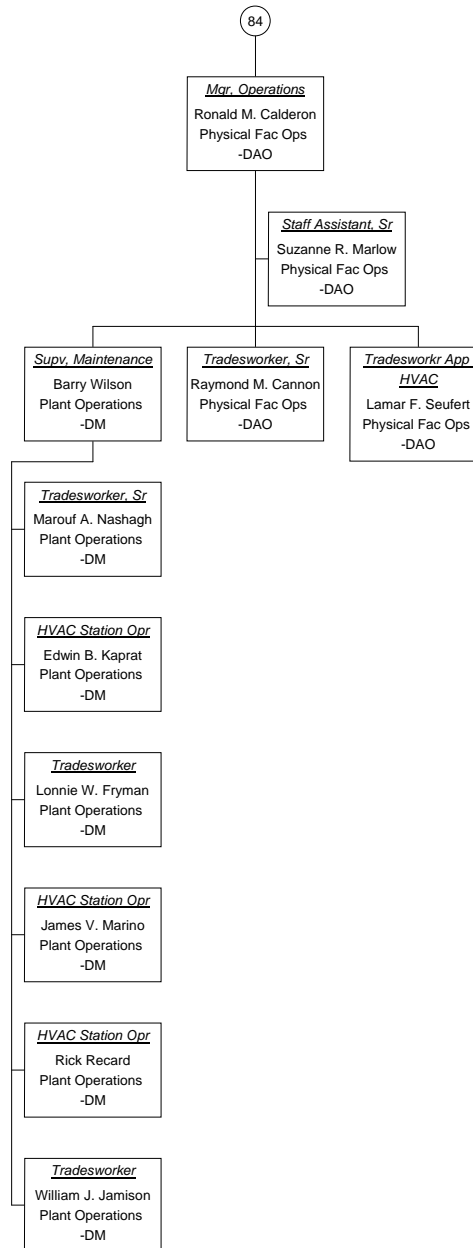

Vacant Position
Cabinet Position



**VP, Info Technology As of
09/04/2008**

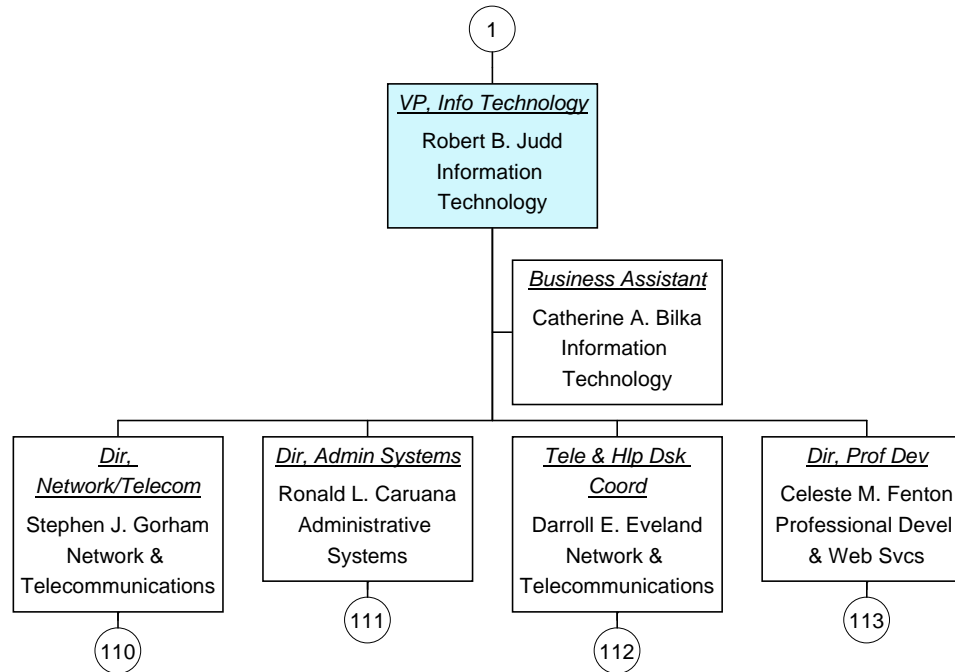

Vacant Position
 Cabinet Position



**Dir, Network/Telecom As of
09/04/2008**

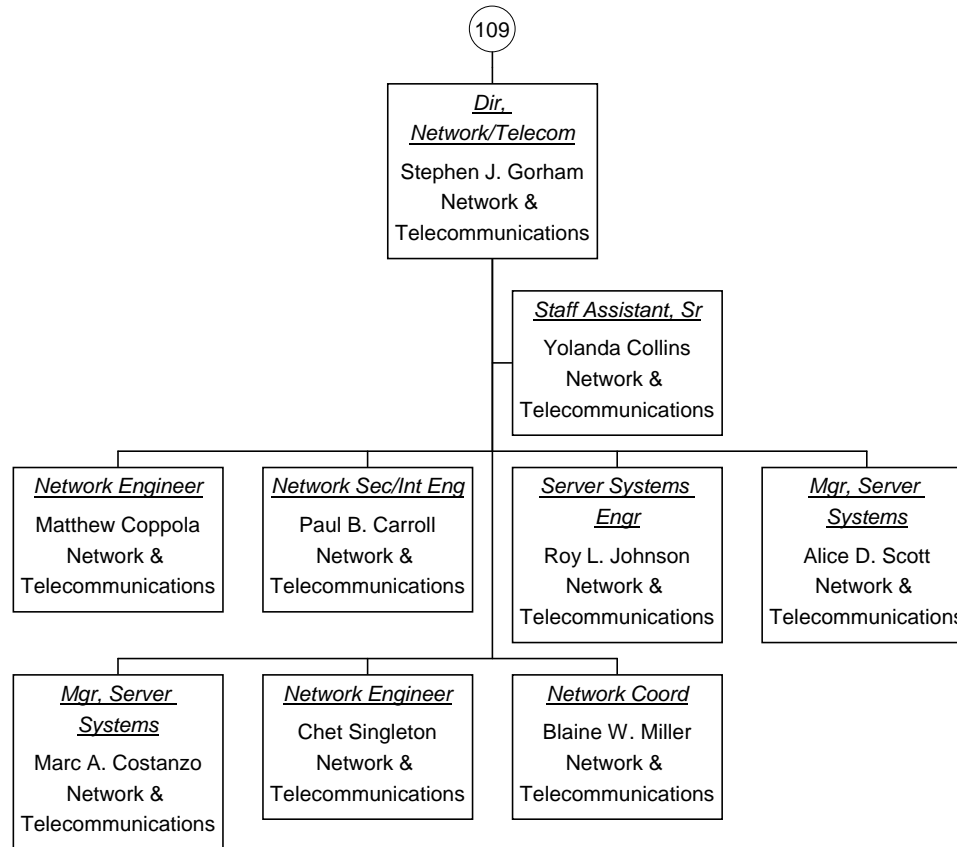

Vacant Position
 Cabinet Position



**Dir, Admin Systems As of
09/04/2008**

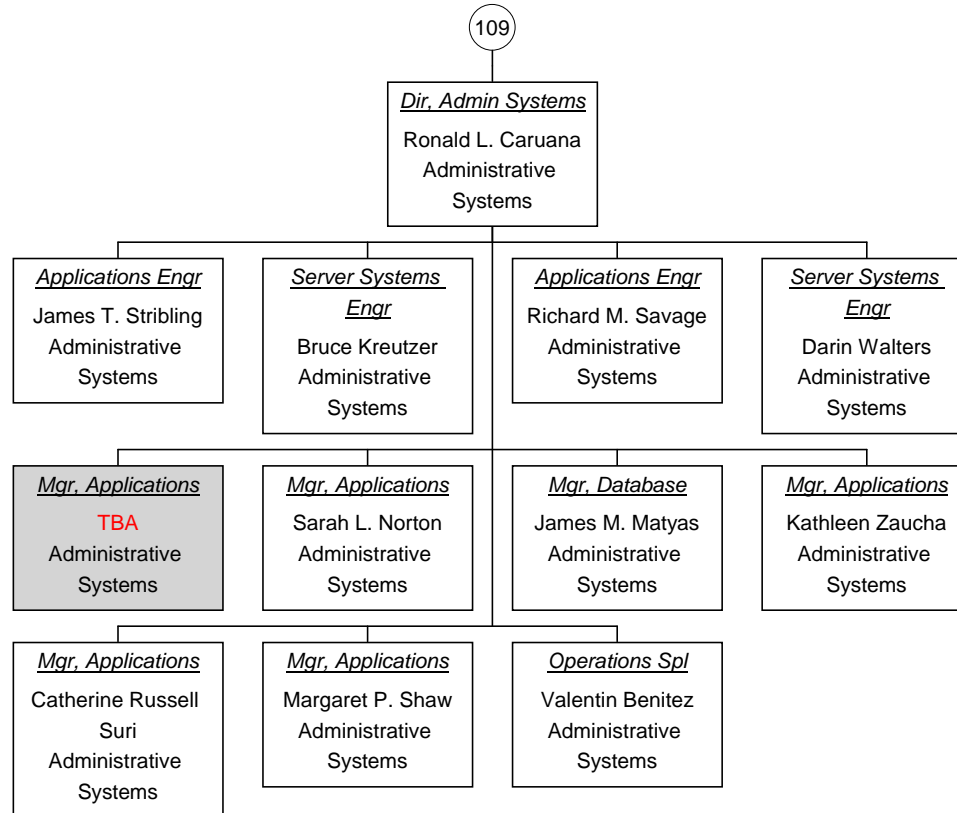

Vacant Position
 Cabinet Position



**Tele & Hlp Dsk Coord As of
09/04/2008**

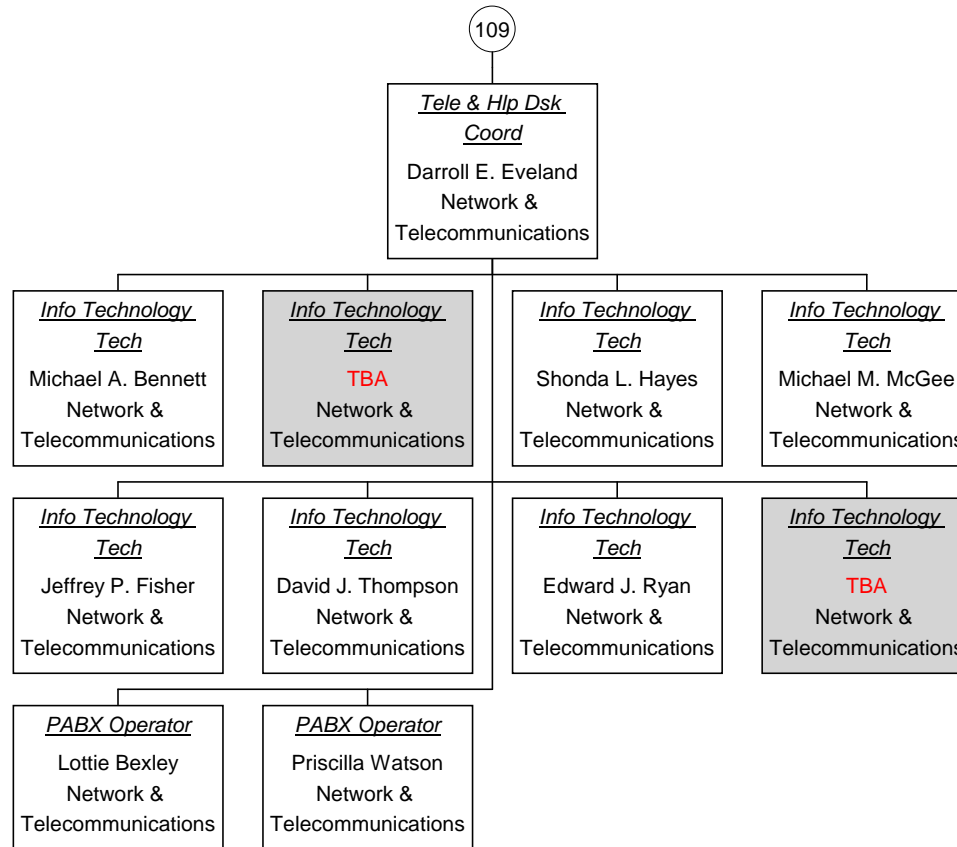

Vacant Position
 Cabinet Position



Dir, Prof Dev As of 09/04/2008

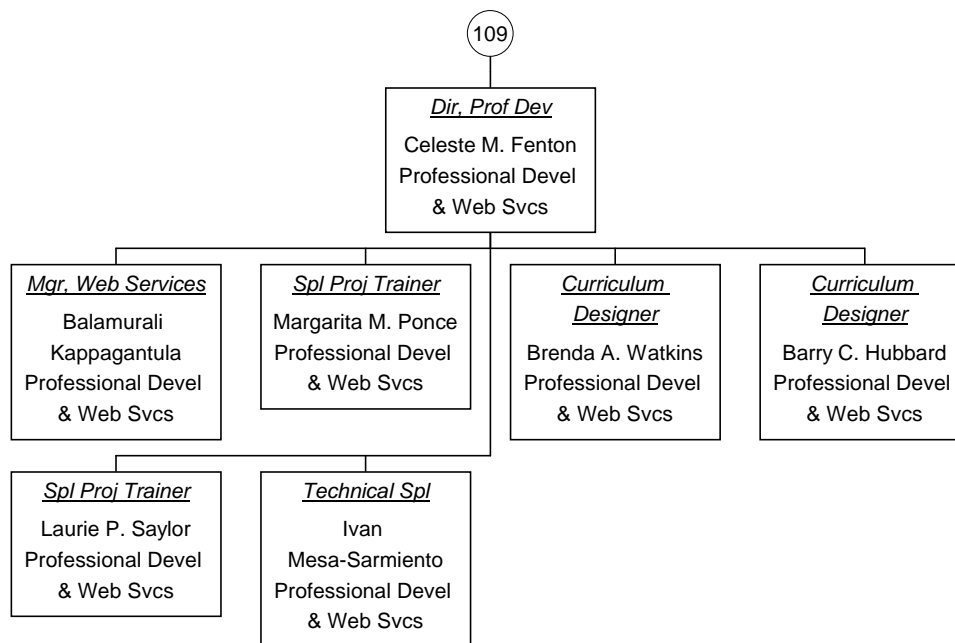

Vacant Position
Cabinet Position

**Spl Asst to Pres As of
09/04/2008**

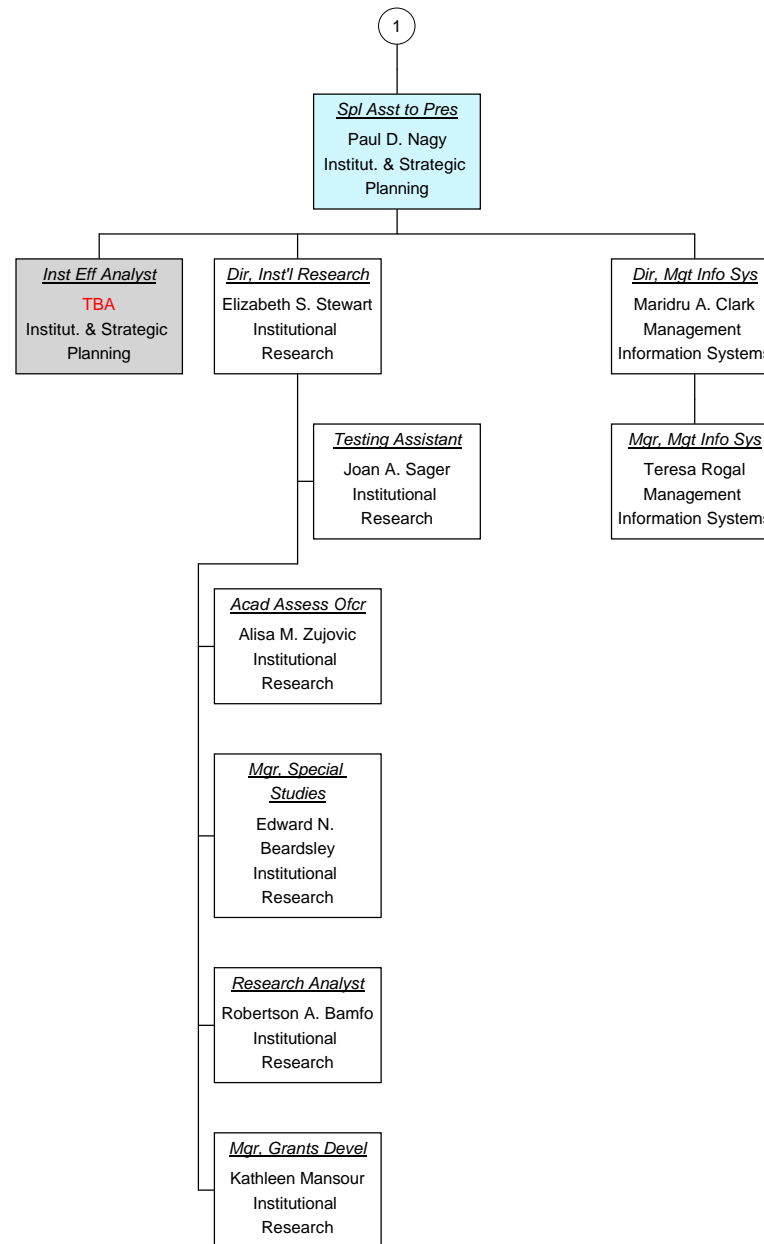

Vacant Position
 Cabinet Position

**ExDir, Human Rsrcs As of
09/04/2008**

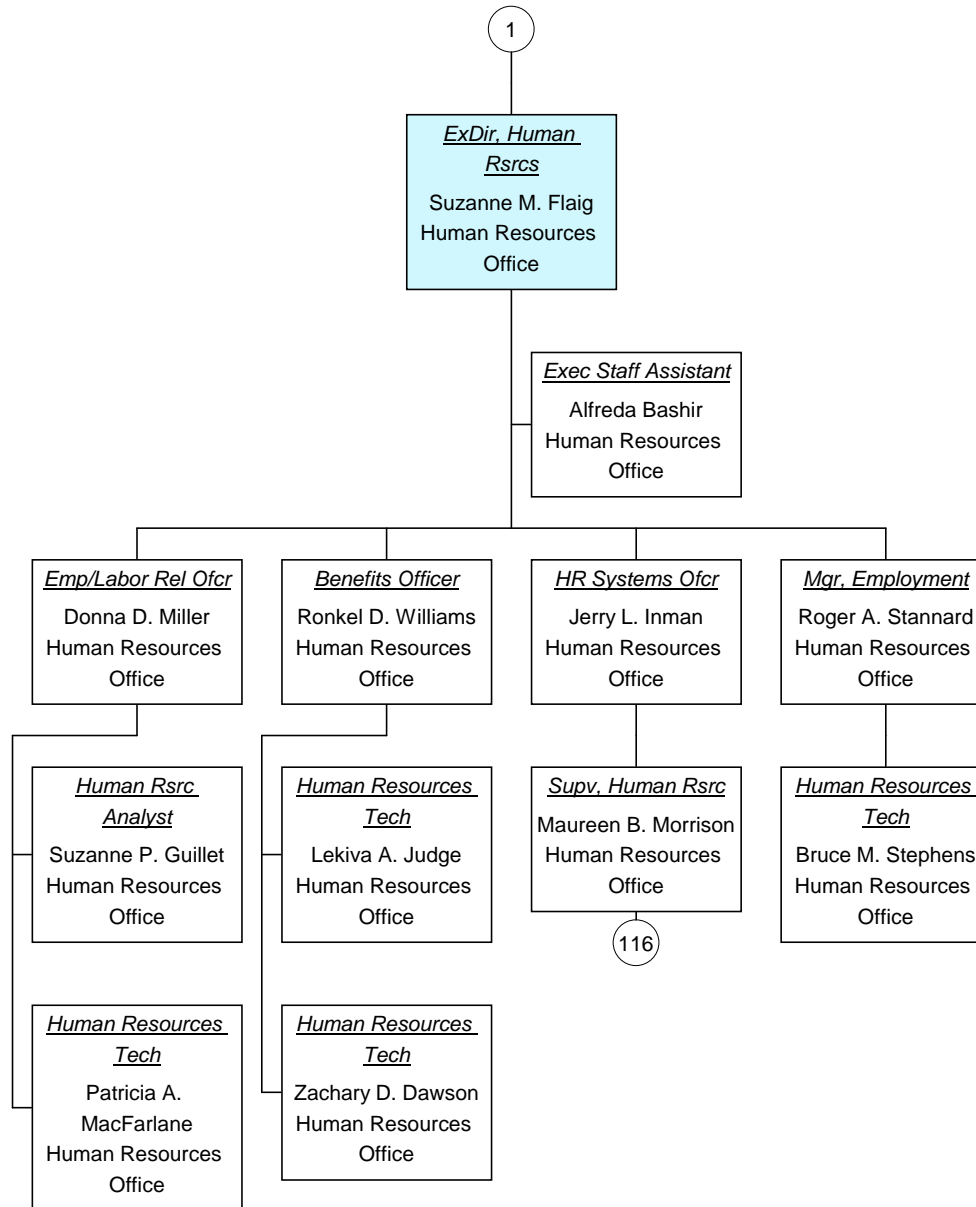

Vacant Position
 Cabinet Position



Supv, Human Rsrc As of 09/04/2008

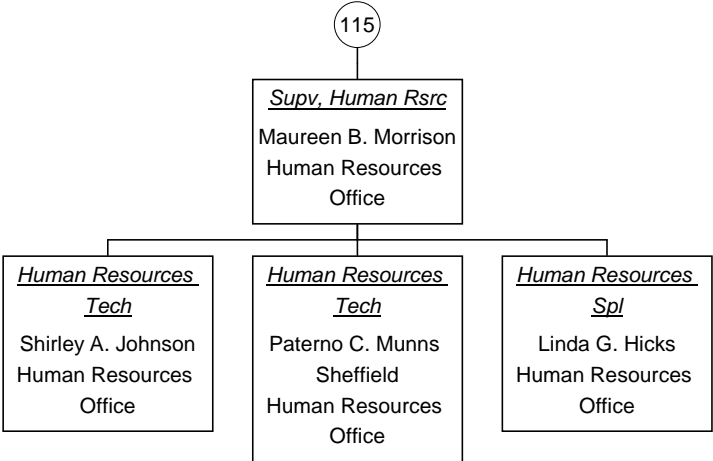

Vacant Position
 Cabinet Position



**ExDir, Mktg & PubRel As of
09/04/2008**

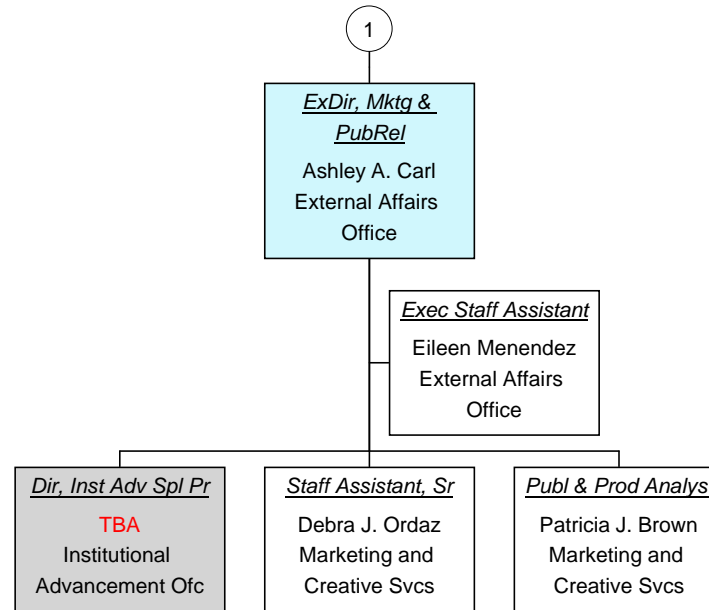

Vacant Position
 Cabinet Position



**Exdir, Foundation As of
09/04/2008**

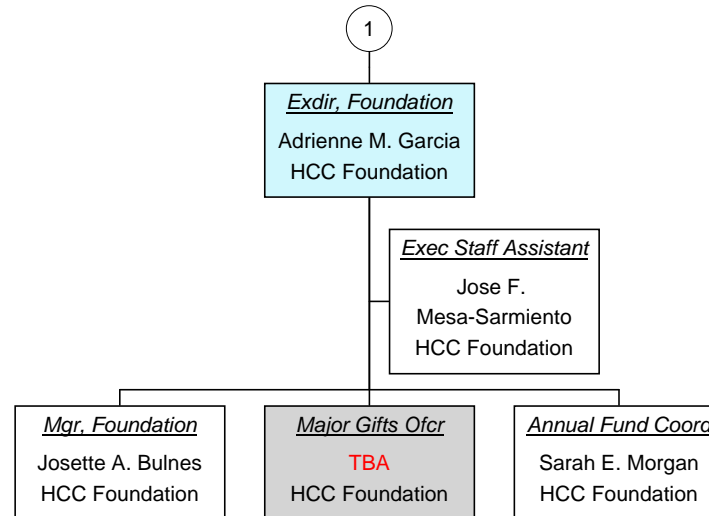

Vacant Position
 Cabinet Position