

# HILLSBOROUGH

Community College



*October 2008*



College President As of  
10/22/2008

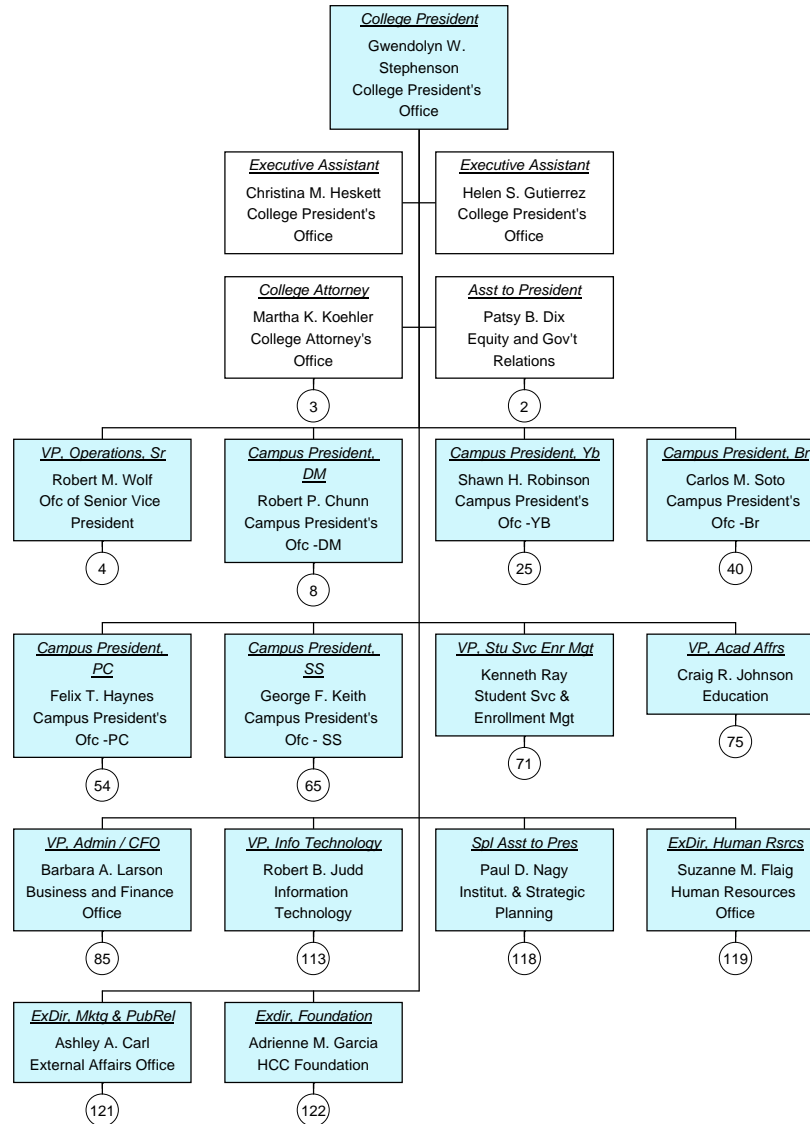

Vacant Position  
 Cabinet Position



**Asst to President As of  
10/22/2008**

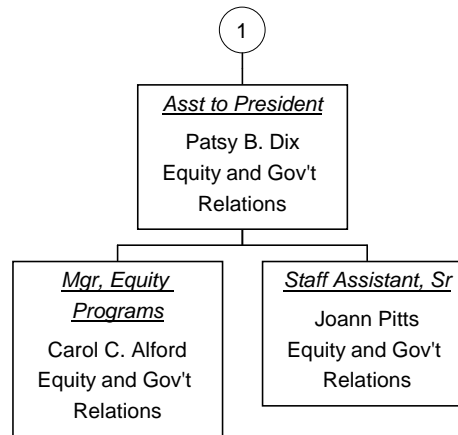

■ Vacant Position  
■ Cabinet Position



College Attorney As of  
10/22/2008

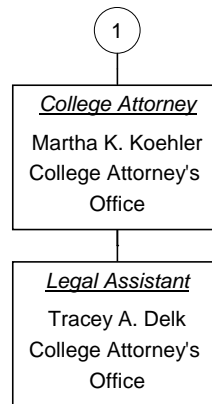

■ Vacant Position  
■ Cabinet Position

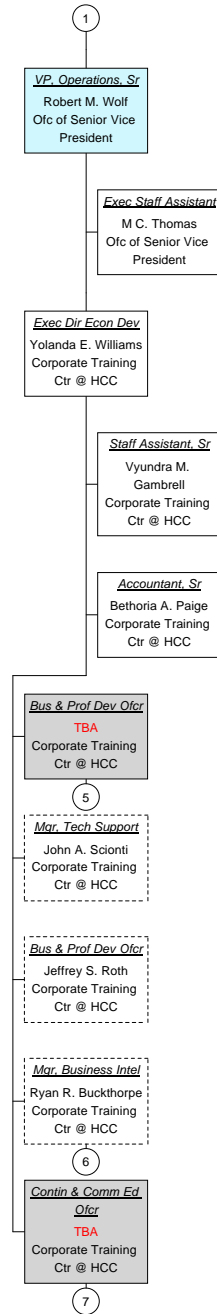

Vacant Position  
Cabinet Position



**Bus & Prof Dev Ofcr As of  
10/22/2008**

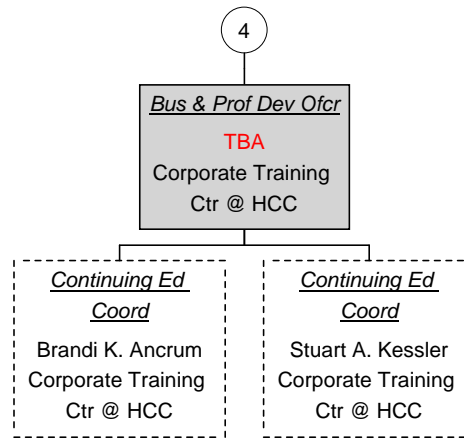

■ Vacant Position  
■ Cabinet Position



**Mgr, Business Intel As of  
10/22/2008**

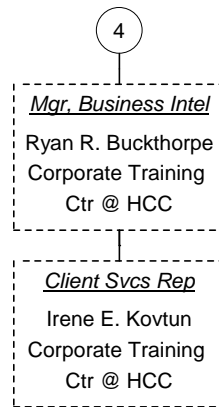

■ Vacant Position  
■ Cabinet Position



**Contin & Comm Ed Ofcr As of  
10/22/2008**

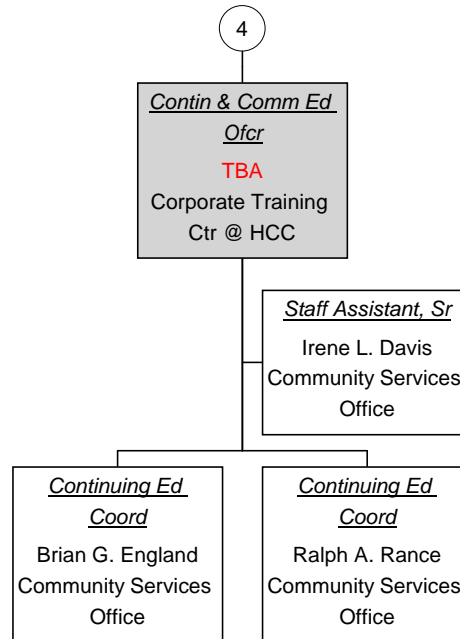

■ Vacant Position  
■ Cabinet Position



**Campus President, DM As of  
10/22/2008**

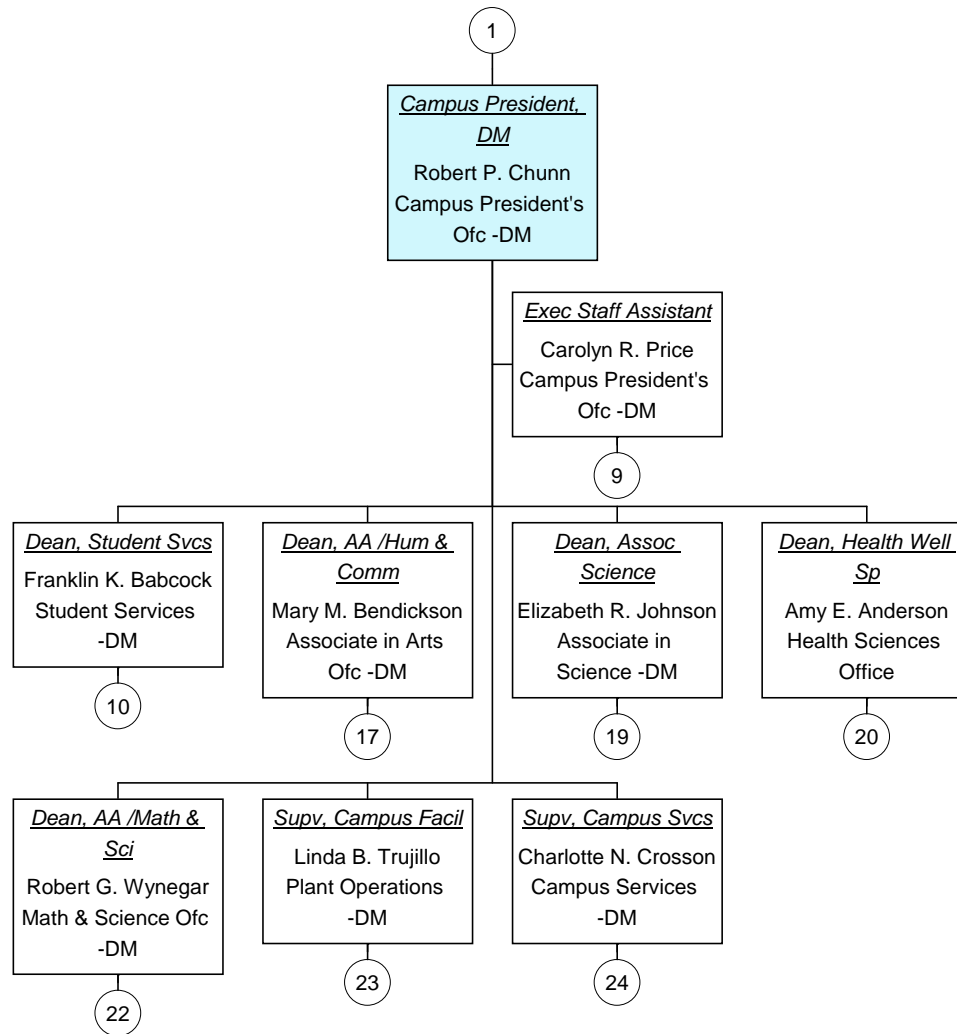

Vacant Position  
 Cabinet Position



**Exec Staff Assistant As of  
10/22/2008**

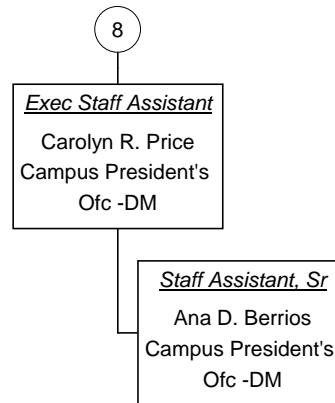

■ Vacant Position  
■ Cabinet Position



Dean, Student Svcs As of  
10/22/2008

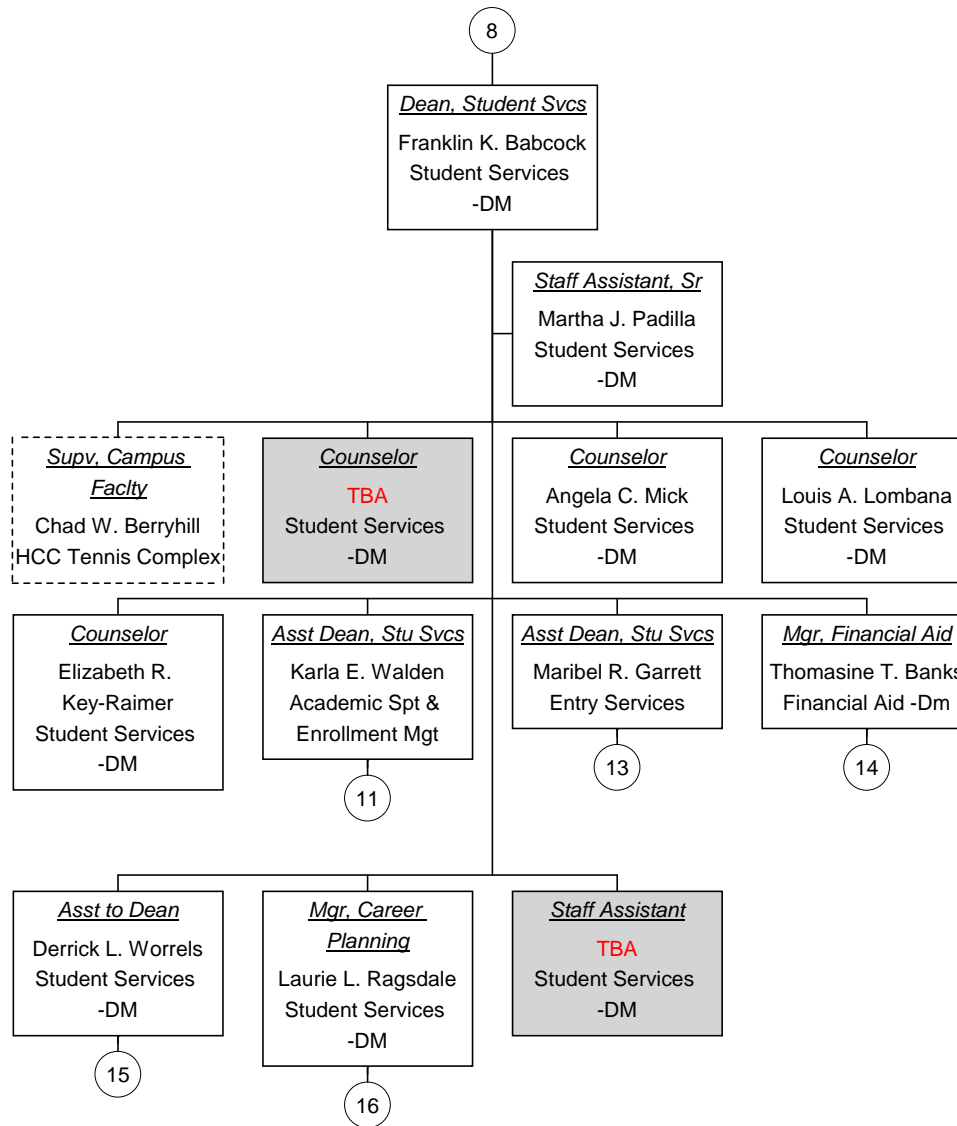

Vacant Position  
 Cabinet Position



**Asst Dean, Stu Svcs As of  
10/22/2008**

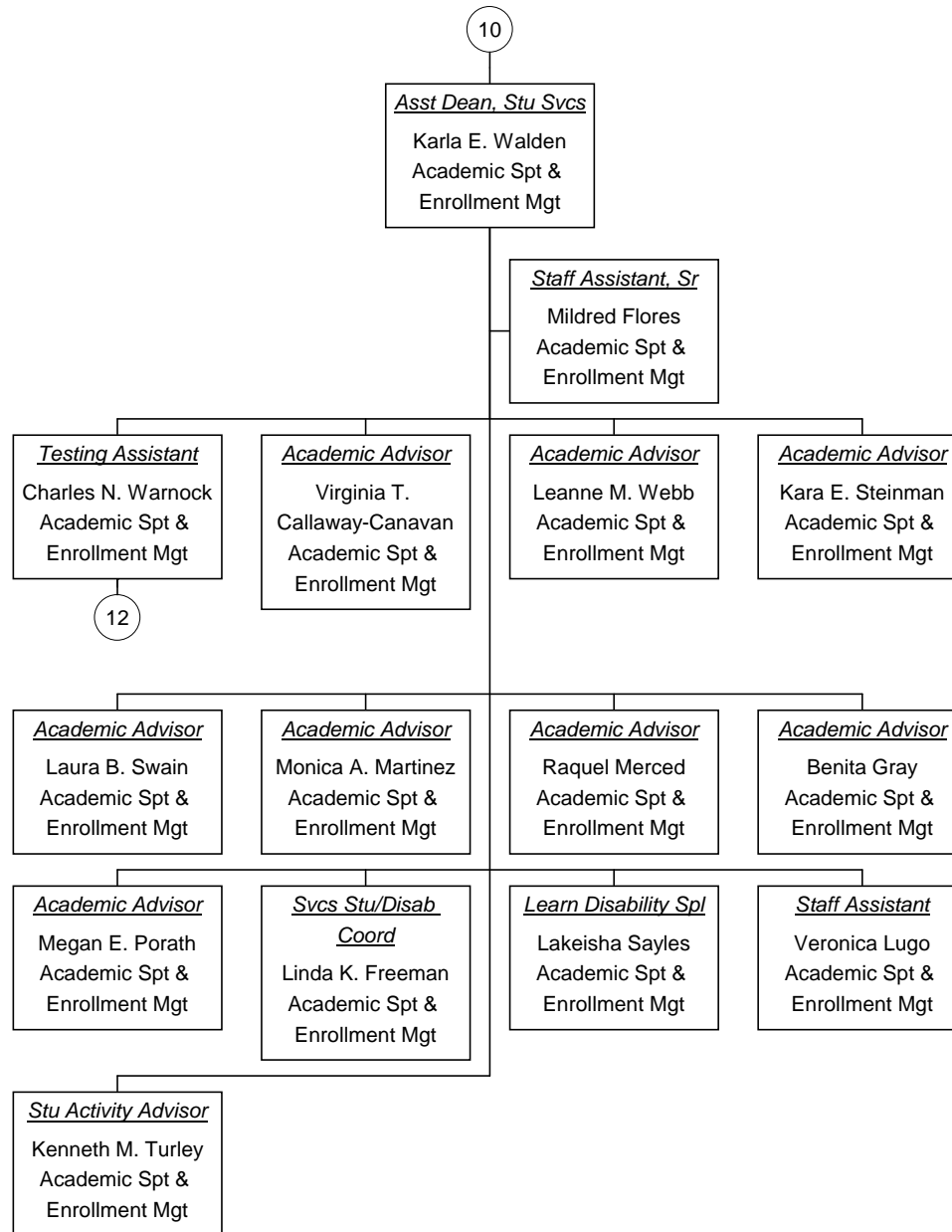

Vacant Position  
 Cabinet Position



Testing Assistant As of  
10/22/2008

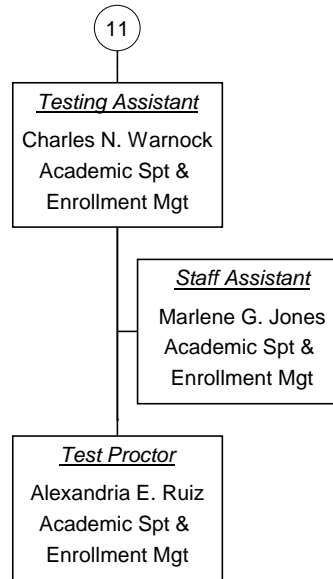

■ Vacant Position  
■ Cabinet Position



**Asst Dean, Stu Svcs As of  
10/22/2008**

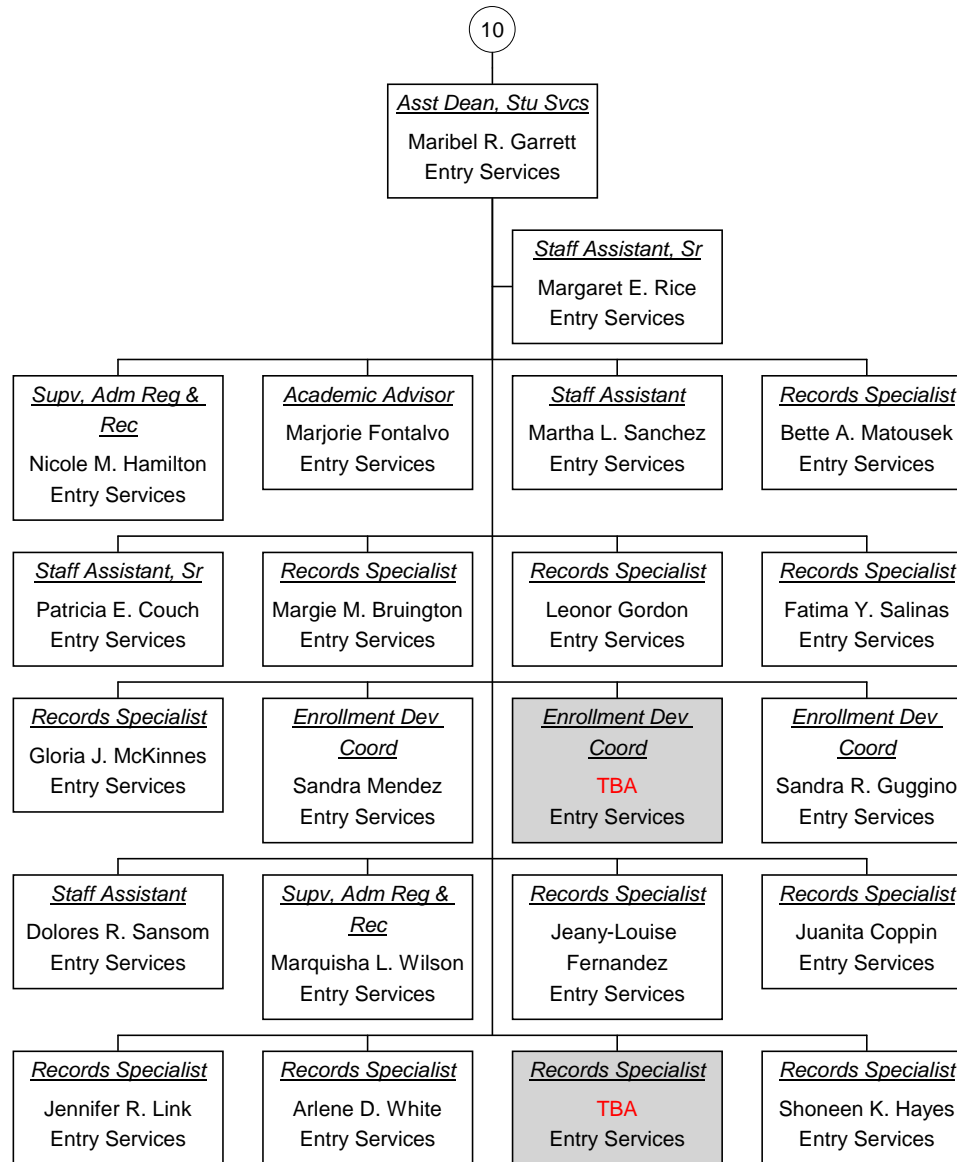

Vacant Position  
 Cabinet Position



**Mgr, Financial Aid As of  
10/22/2008**

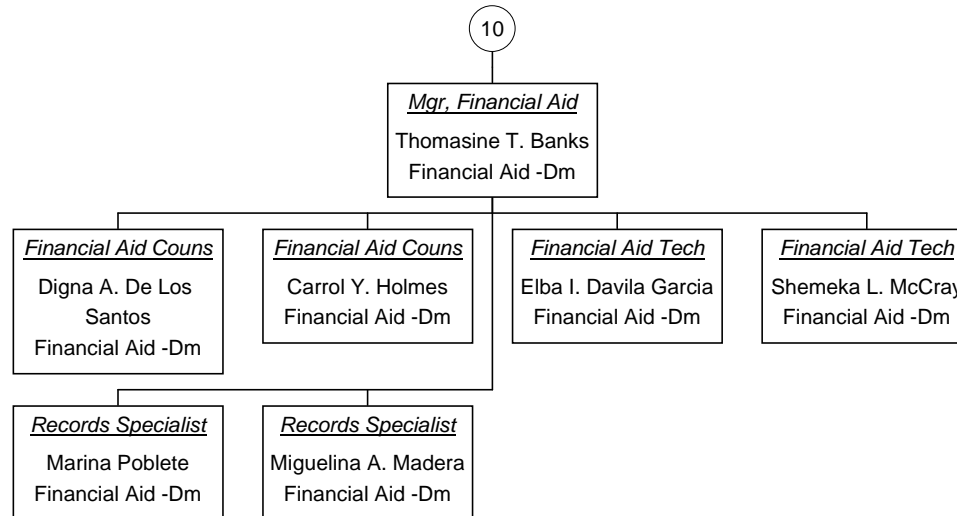

■ Vacant Position  
■ Cabinet Position



Asst to Dean As of 10/22/2008

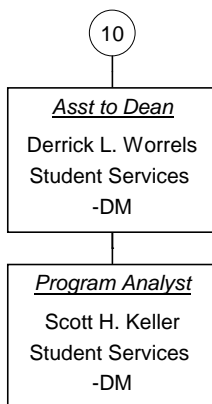

■ Vacant Position  
■ Cabinet Position



**Mgr, Career Planning As of  
10/22/2008**

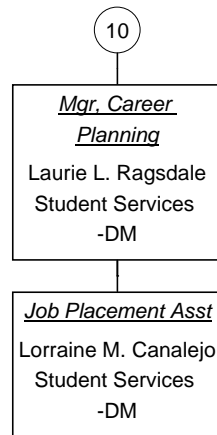

■ Vacant Position  
■ Cabinet Position

Dean, AA/Hum & Comm As of  
10/22/2008

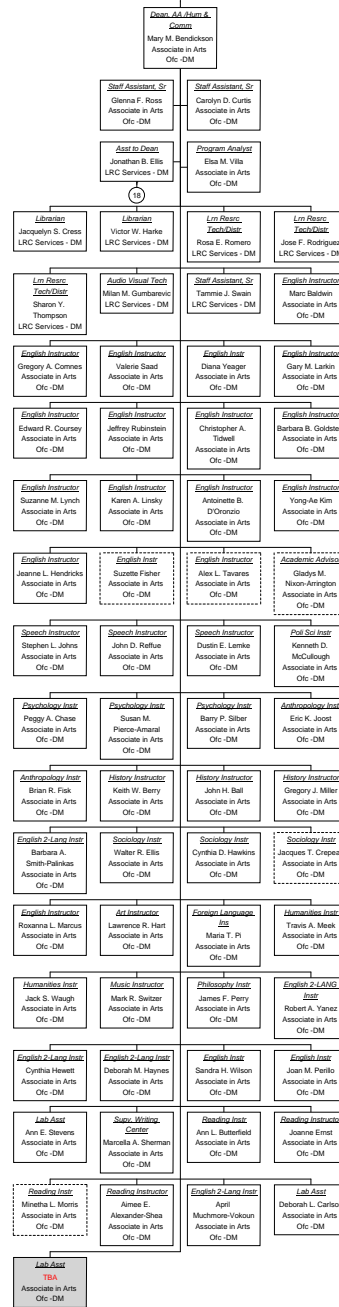

Vacant Position  
Cabinet Position



Asst to Dean As of 10/22/2008

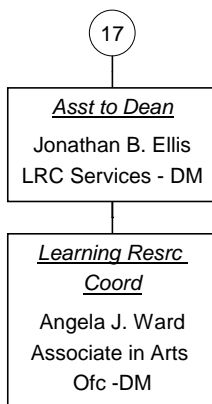

Vacant Position  
Cabinet Position

**Dean, Assoc Science As of  
10/22/2008**

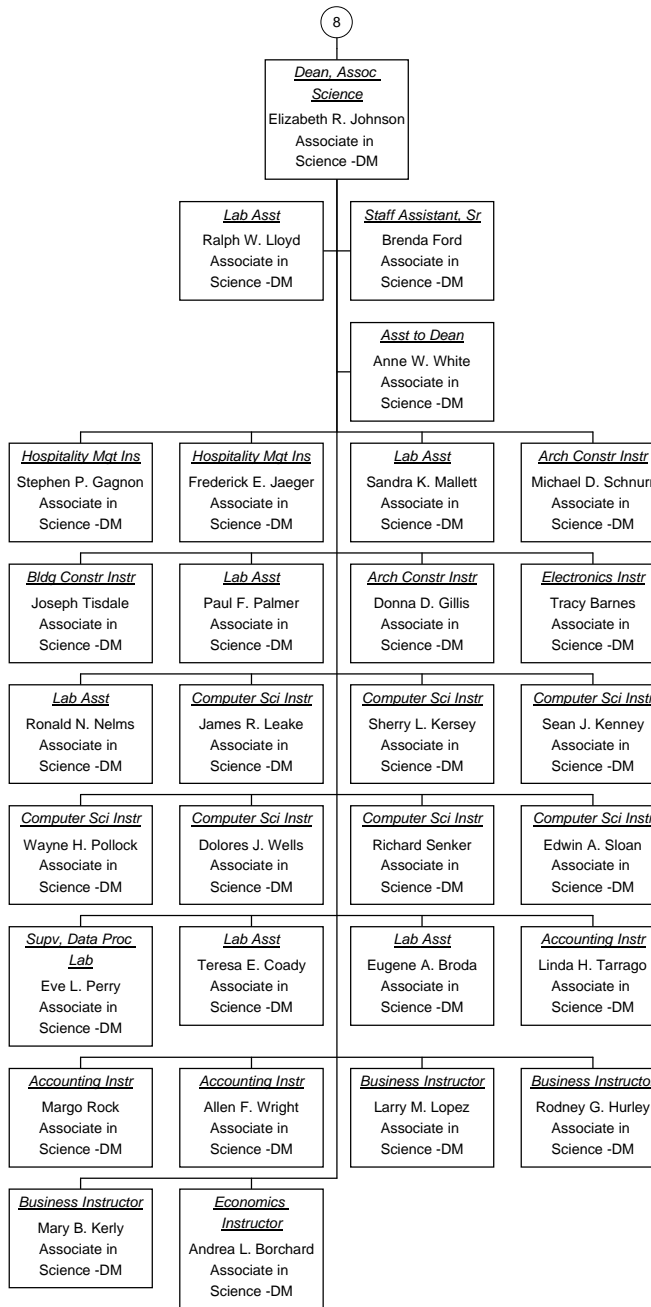

  Vacant Position  
  Cabinet Position

Dean, Health Well Sp As of  
10/22/2008

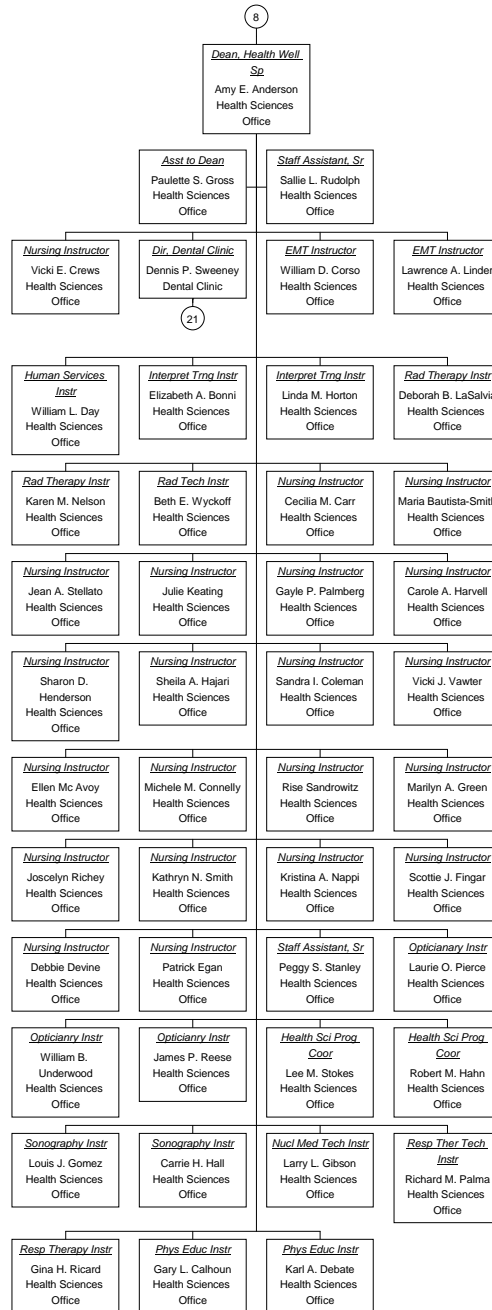

Vacant Position  
Cabinet Position



**Dir, Dental Clinic As of  
10/22/2008**

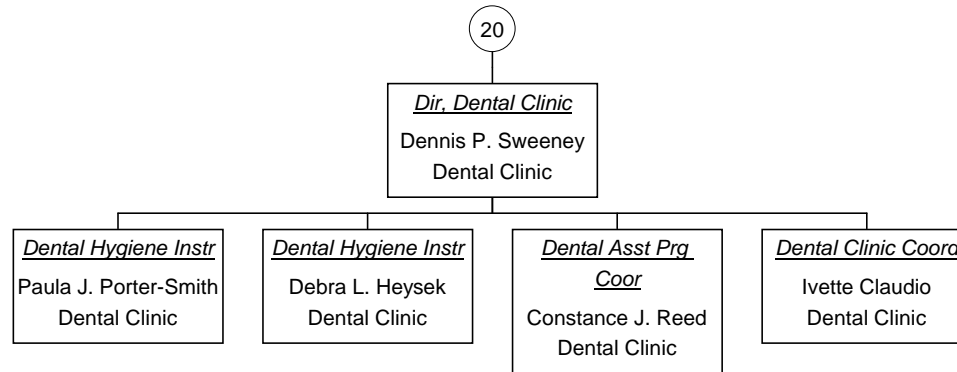

■ Vacant Position  
■ Cabinet Position

Dean, AA /Math & Sci as of  
10/22/2008

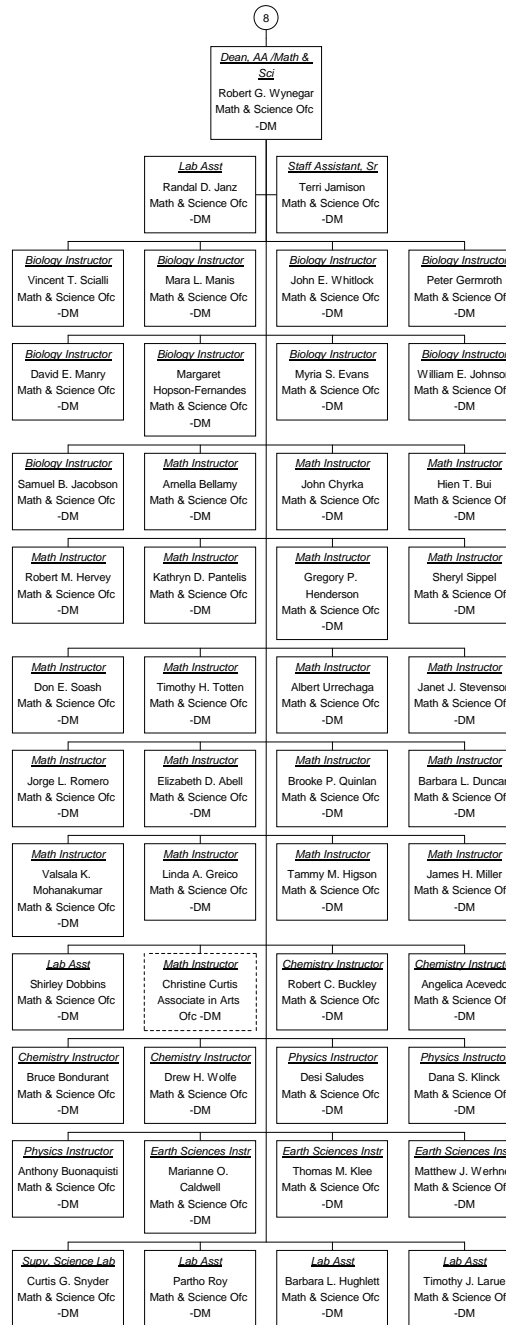

Vacant Position  
Cabinet Position



**Supv, Campus Facil As of  
10/22/2008**

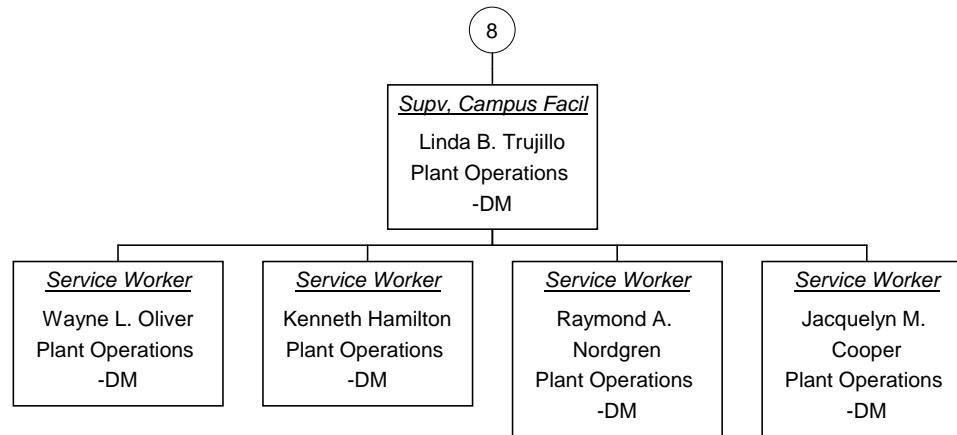

■ Vacant Position  
■ Cabinet Position



**Supv, Campus Svcs As of  
10/22/2008**

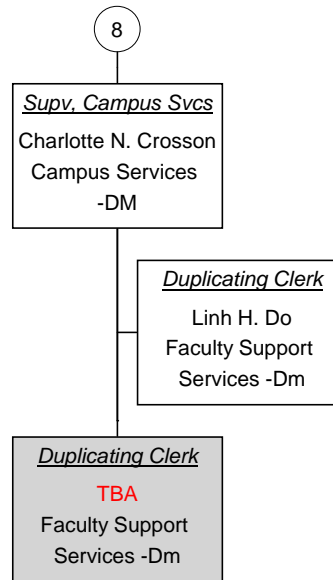

■ Vacant Position  
■ Cabinet Position



**Campus President, Yb As of 10/22/2008**

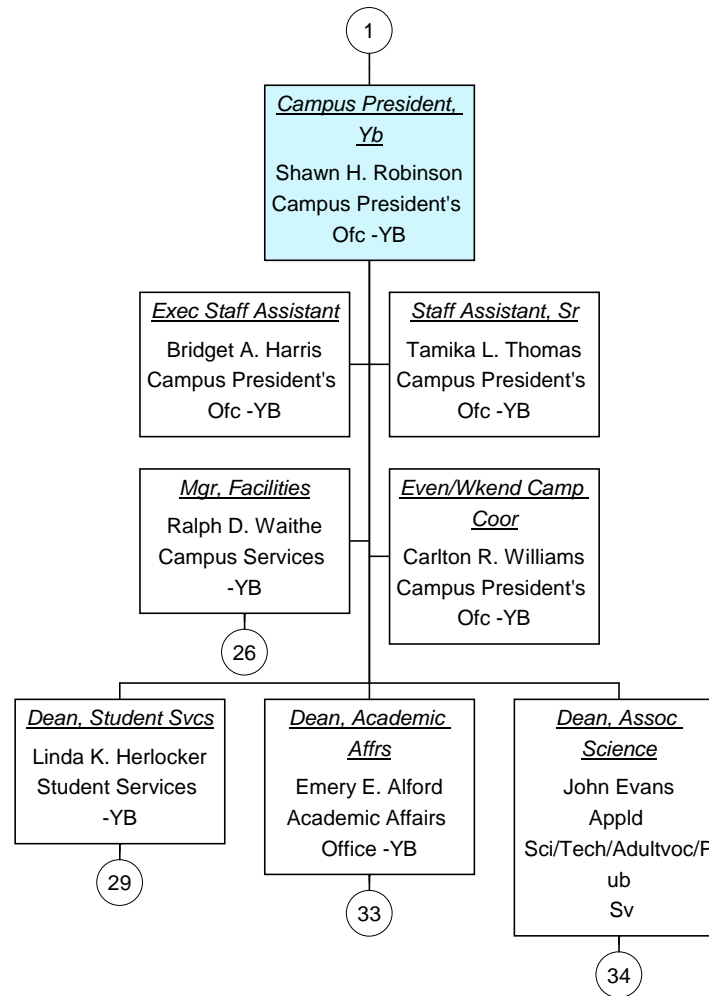

Vacant Position  
 Cabinet Position



Mgr, Facilities As of 10/22/2008

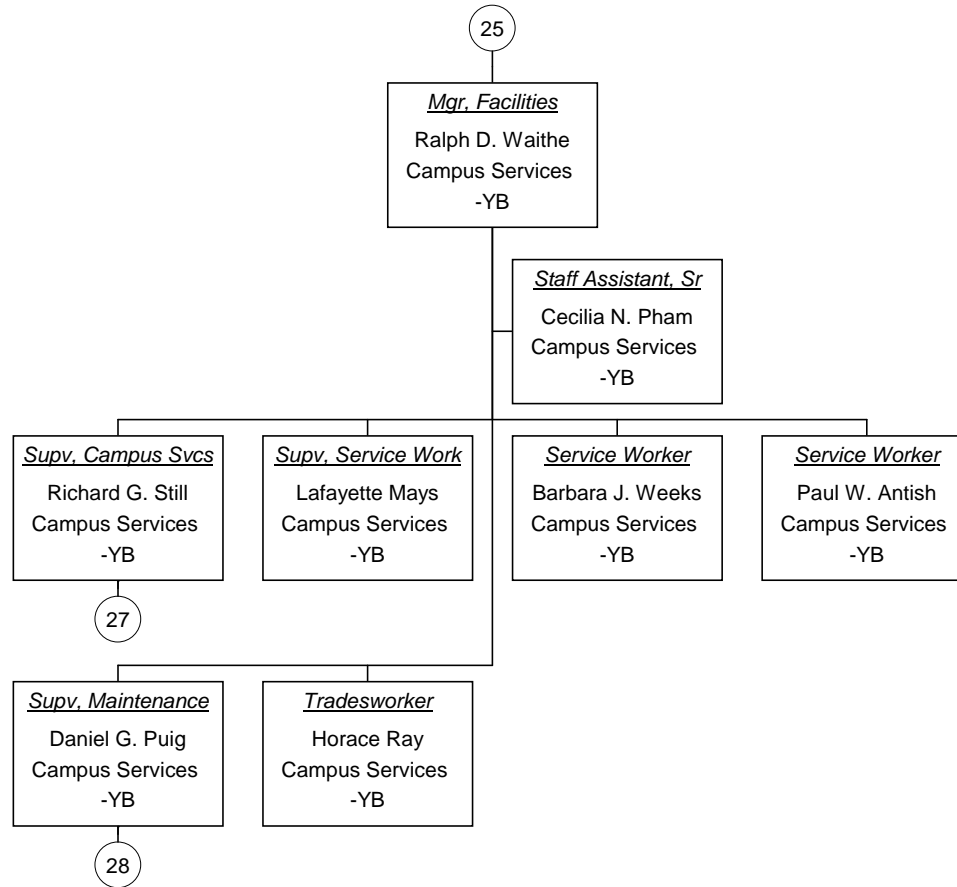

Vacant Position  
 Cabinet Position



**Supv, Campus Svcs As of  
10/22/2008**

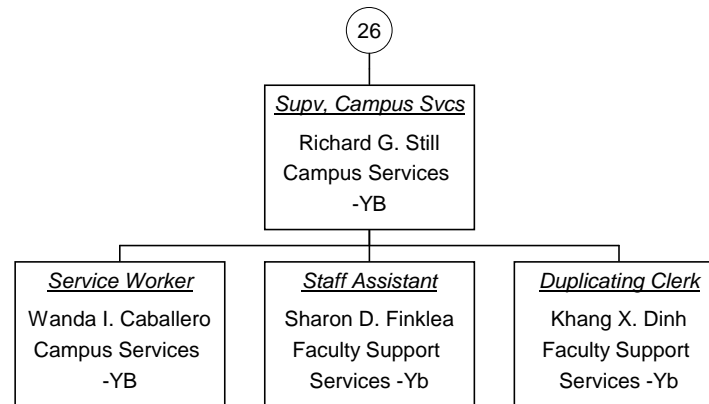

■ Vacant Position  
■ Cabinet Position



Supv, Maintenance As of 10/22/2008

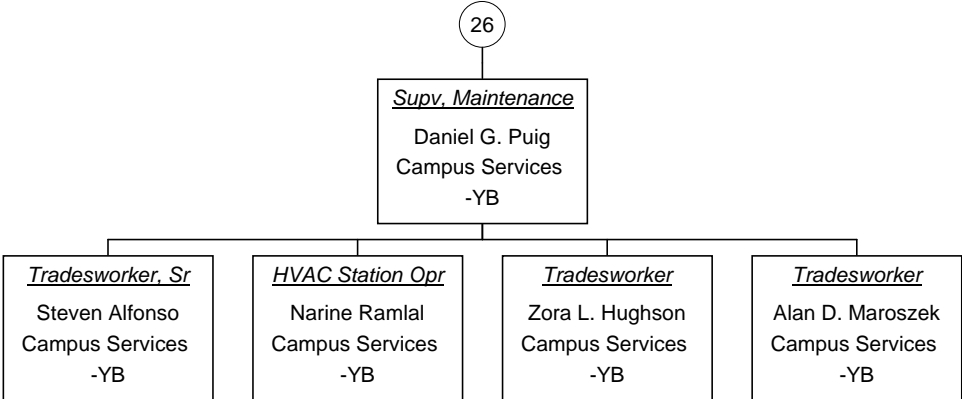

Vacant Position  
 Cabinet Position



Dean, Student Svcs As of  
10/22/2008

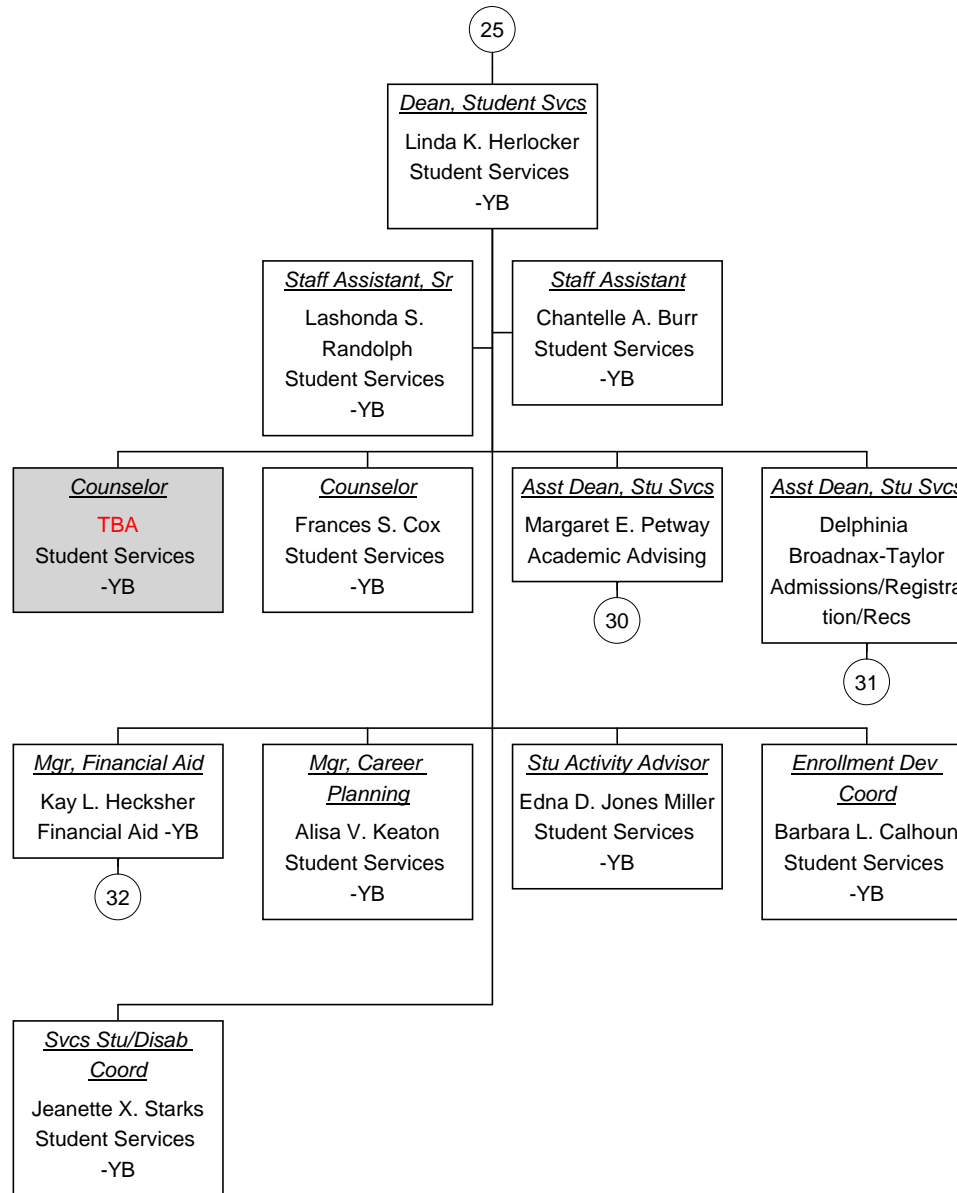

Vacant Position  
 Cabinet Position



**Asst Dean, Stu Svcs As of  
10/22/2008**

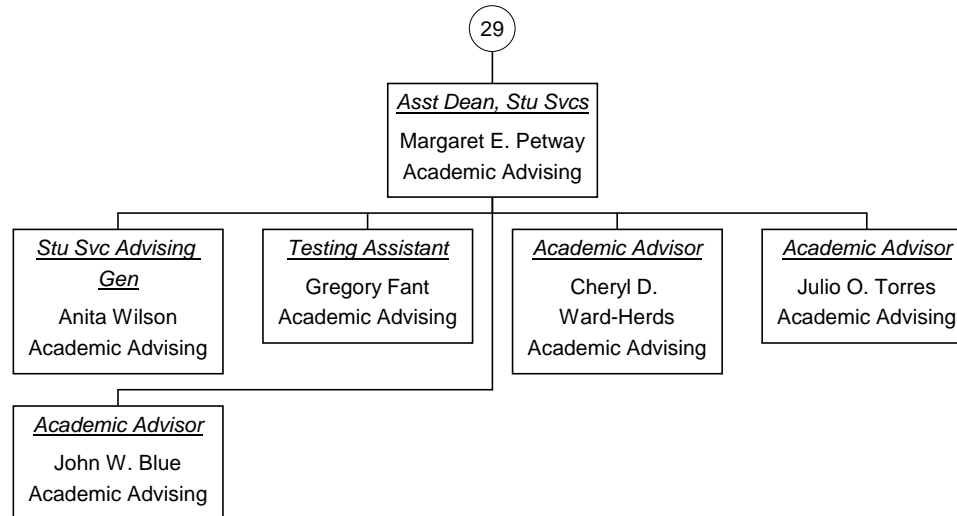

■ Vacant Position  
■ Cabinet Position



**Asst Dean, Stu Svcs As of  
10/22/2008**

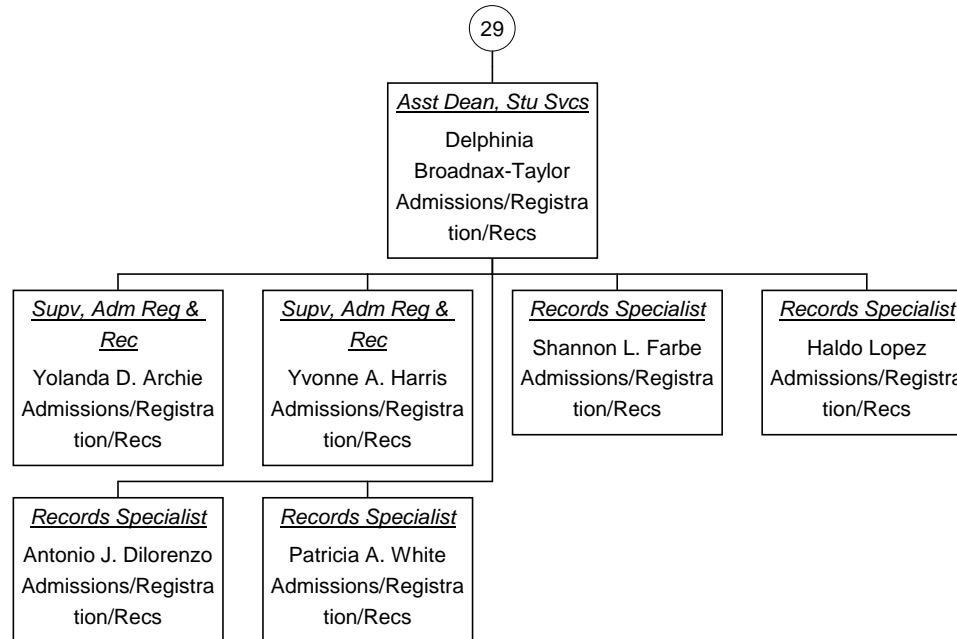

Vacant Position  
 Cabinet Position



**Mgr, Financial Aid As of  
10/22/2008**

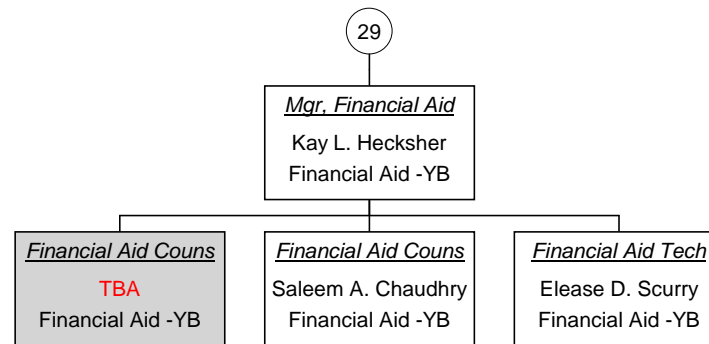

■ Vacant Position  
■ Cabinet Position

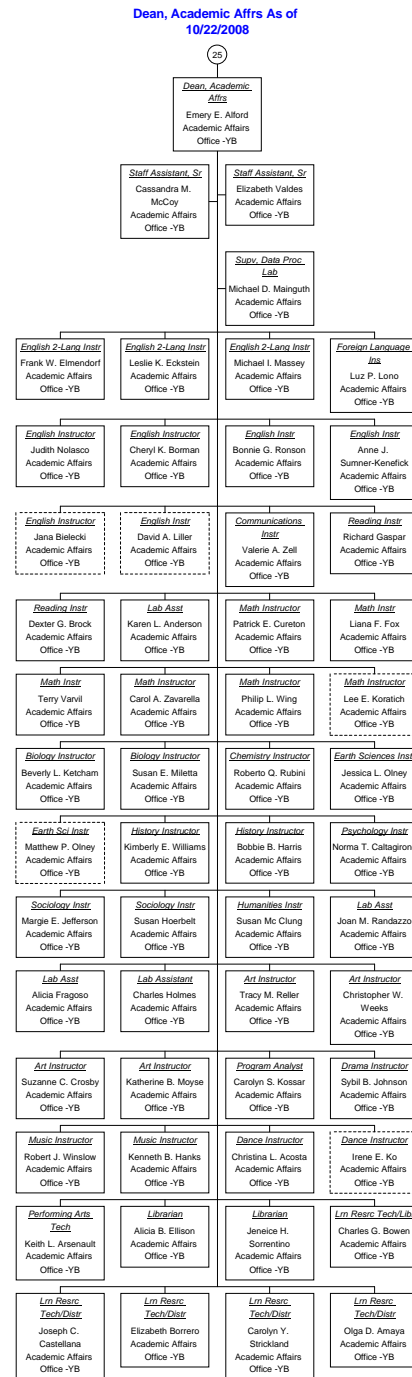

  Vacant Position  
  Cabinet Position  
  Dotted border = Temp Position

Dean, Assoc Science As of  
10/22/2008



Vacant Position  
Cabinet Position



**Pub Svc Prgms Ofcr As of  
10/22/2008**

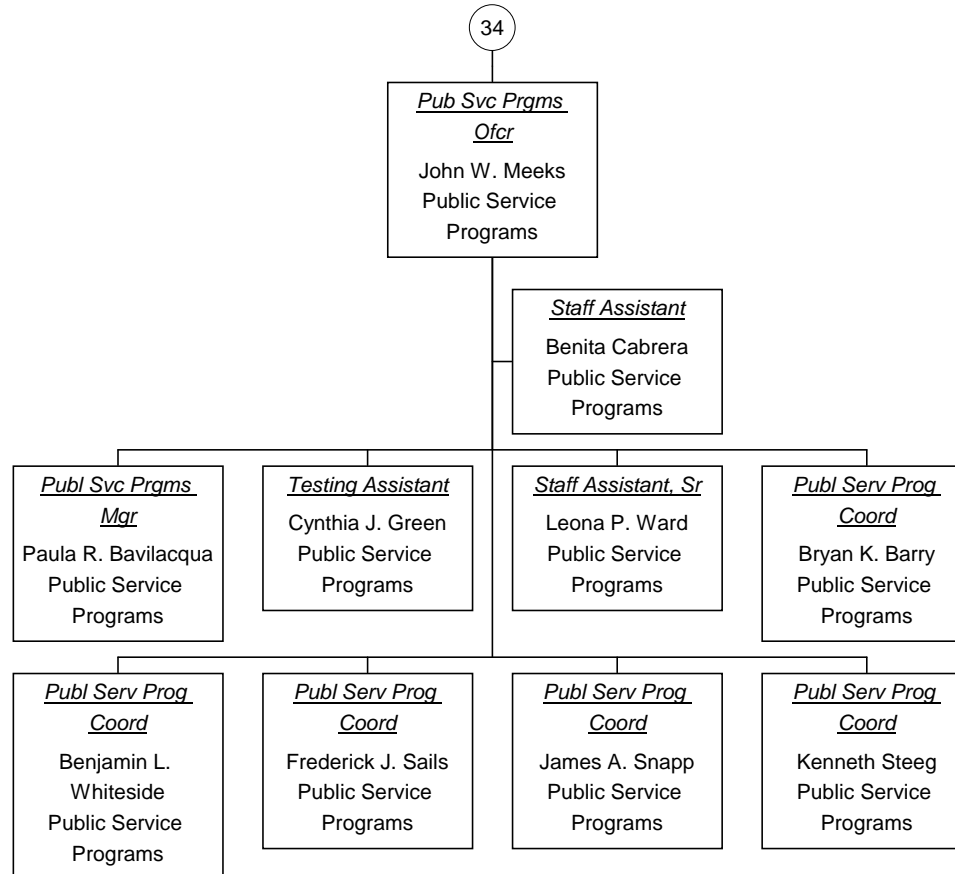

Vacant Position  
 Cabinet Position



**Campus Grants Ofcr As of  
10/22/2008**

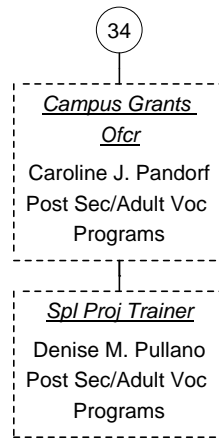

■ Vacant Position  
■ Cabinet Position



Early Childhd Dv Mgr As of  
10/22/2008

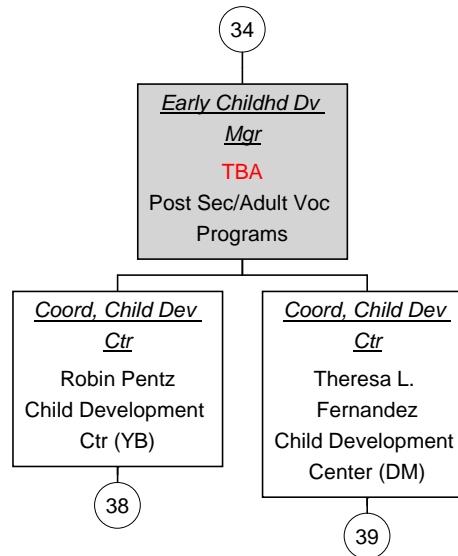

■ Vacant Position  
■ Cabinet Position



**Coord, Child Dev Ctr As of  
10/22/2008**

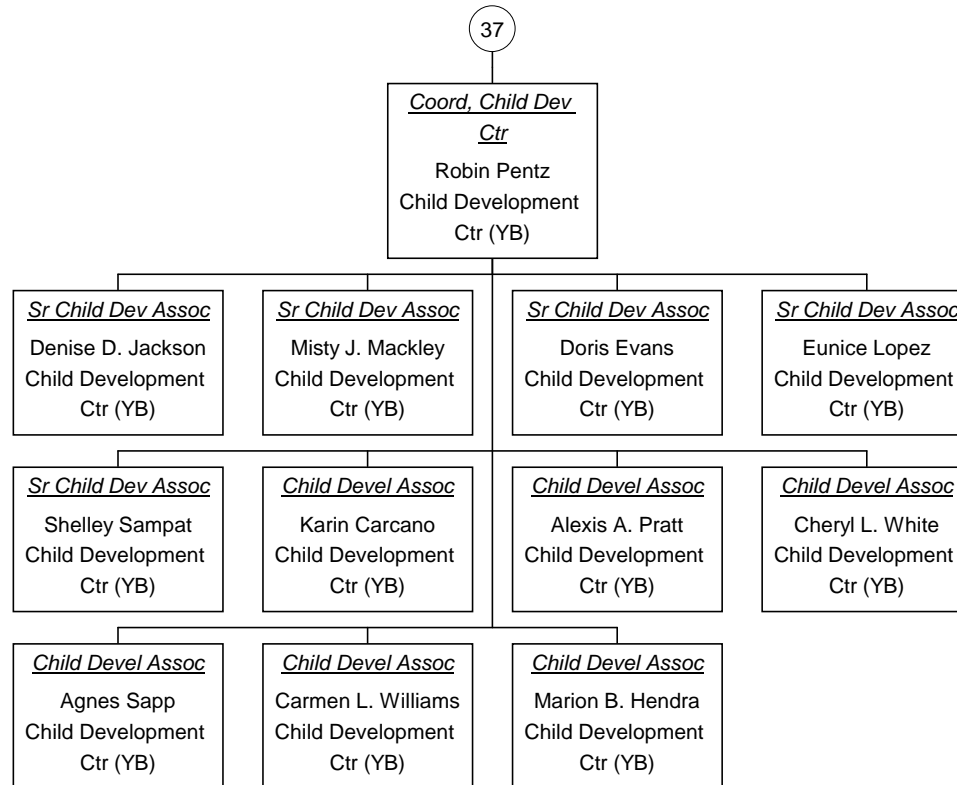

Vacant Position  
 Cabinet Position



**Coord, Child Dev Ctr As of  
10/22/2008**

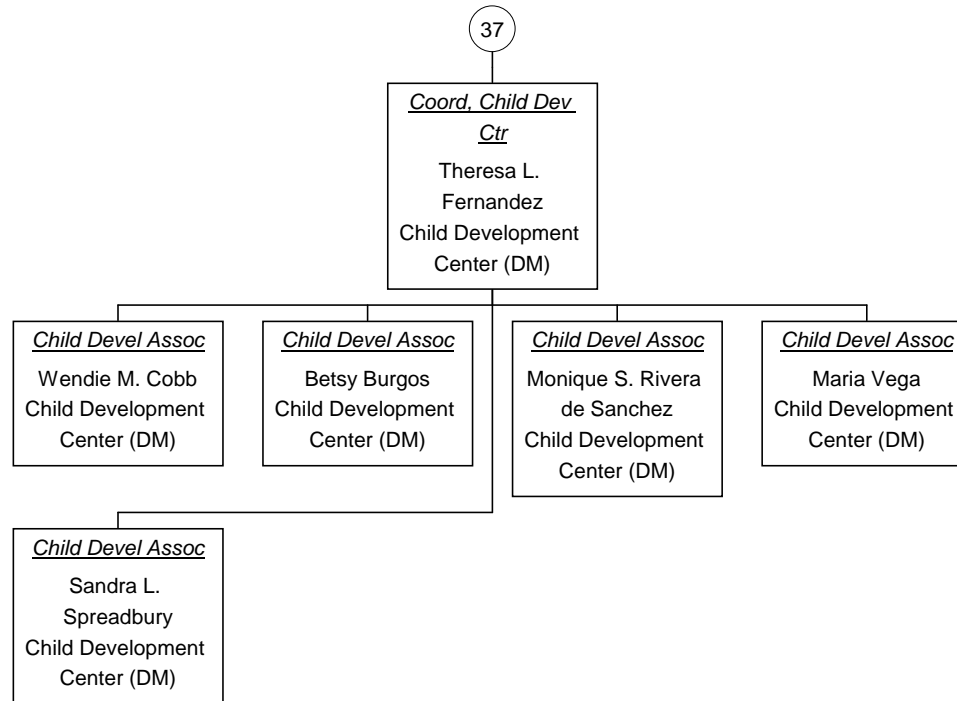

■ Vacant Position  
■ Cabinet Position



**Campus President, Br As of 10/22/2008**

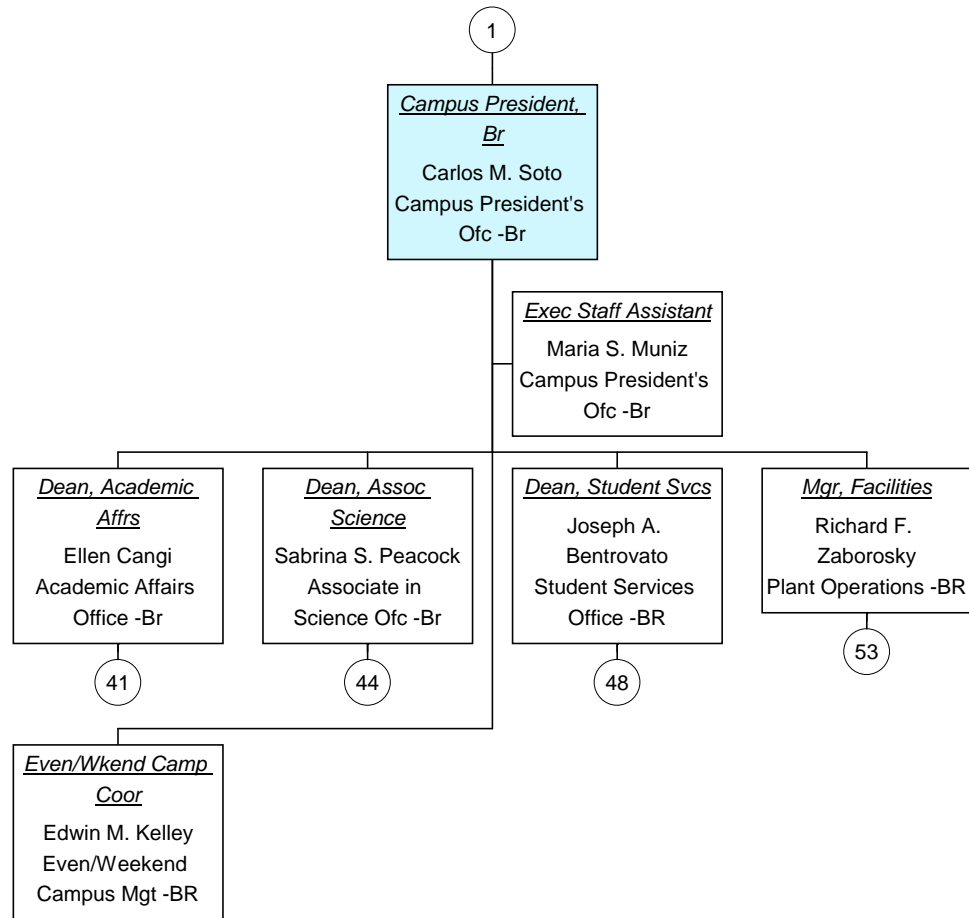

Vacant Position  
 Cabinet Position

Dean, Academic Affrs As of  
10/22/2008

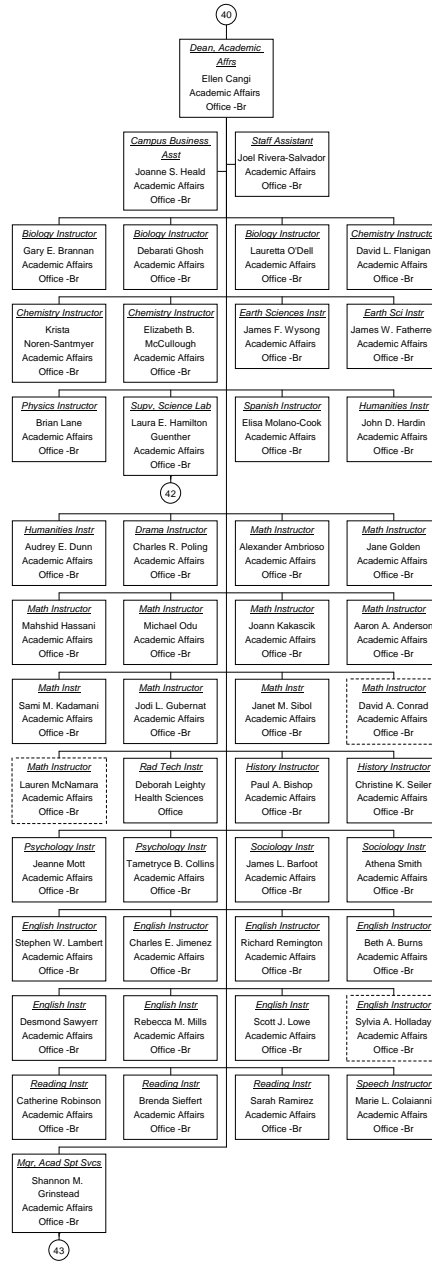

Vacant Position  
Cabinet Position



**Supv, Science Lab As of  
10/22/2008**

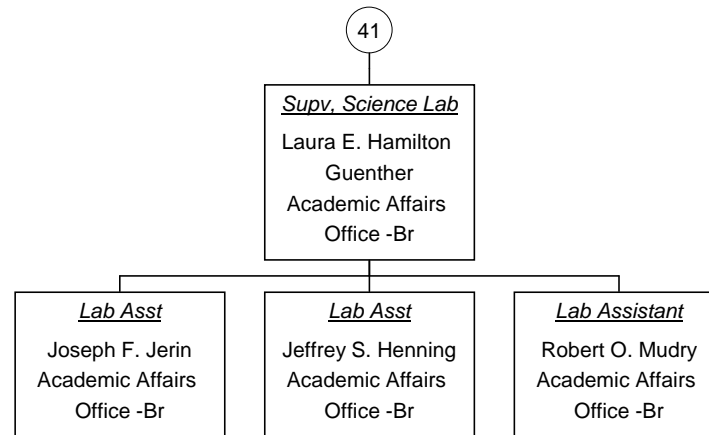

■ Vacant Position  
■ Cabinet Position



**Mgr, Acad Spt Svcs As of  
10/22/2008**

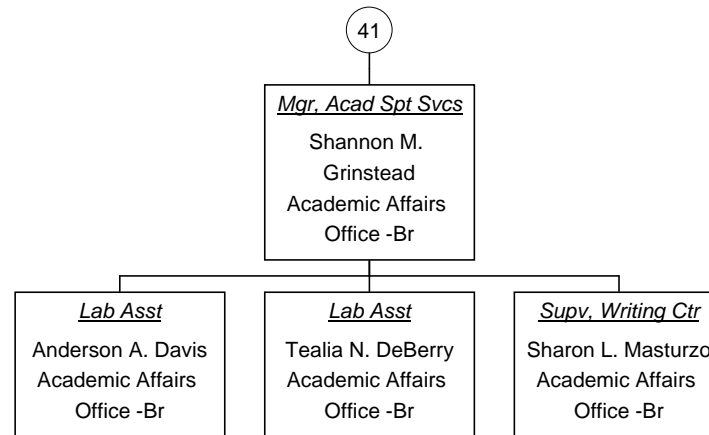

■ Vacant Position  
■ Cabinet Position

**Dean, Assoc Science As of  
10/22/2008**

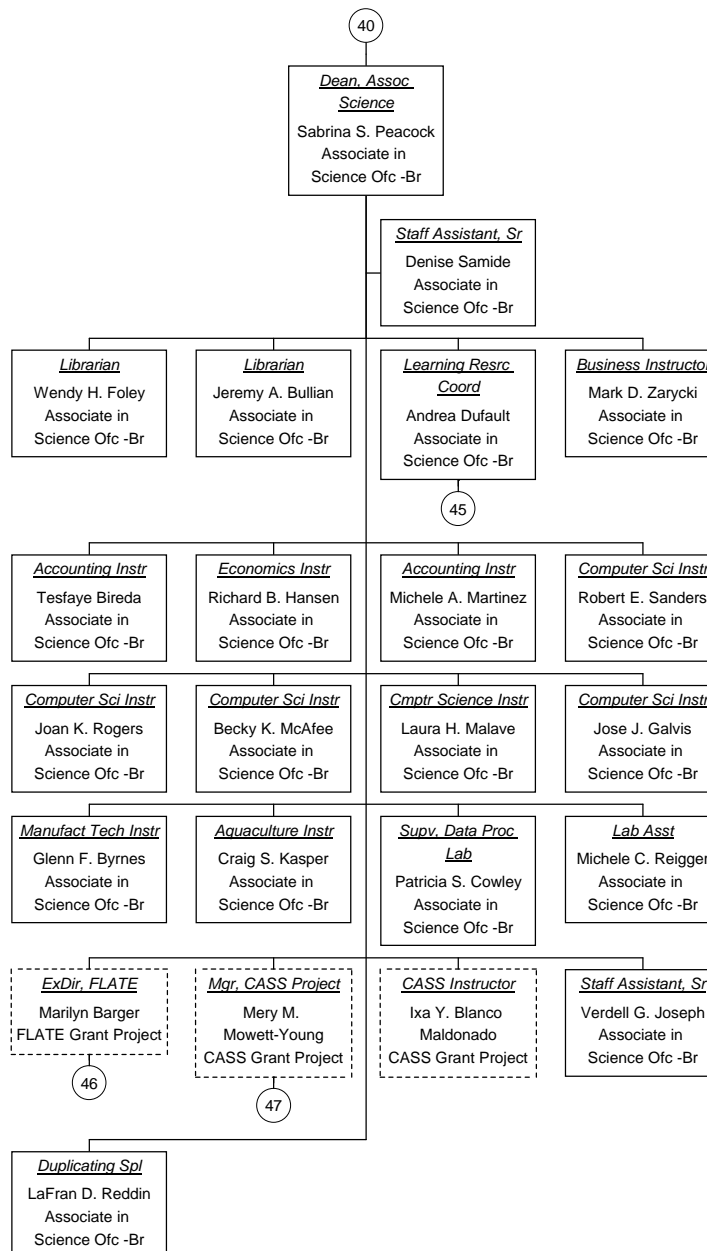

Vacant Position  
 Cabinet Position



### Learning Resrc Coord As of 10/22/2008

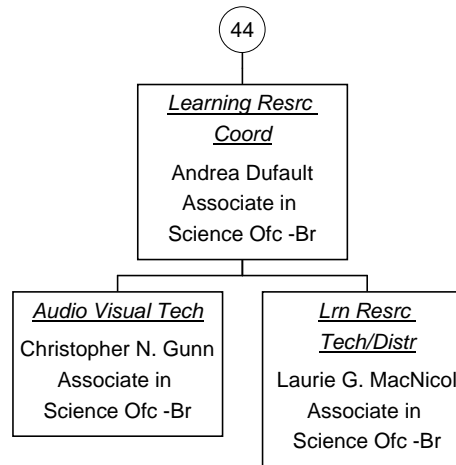

■ Vacant Position  
■ Cabinet Position



ExDir, FLATE As of 10/22/2008

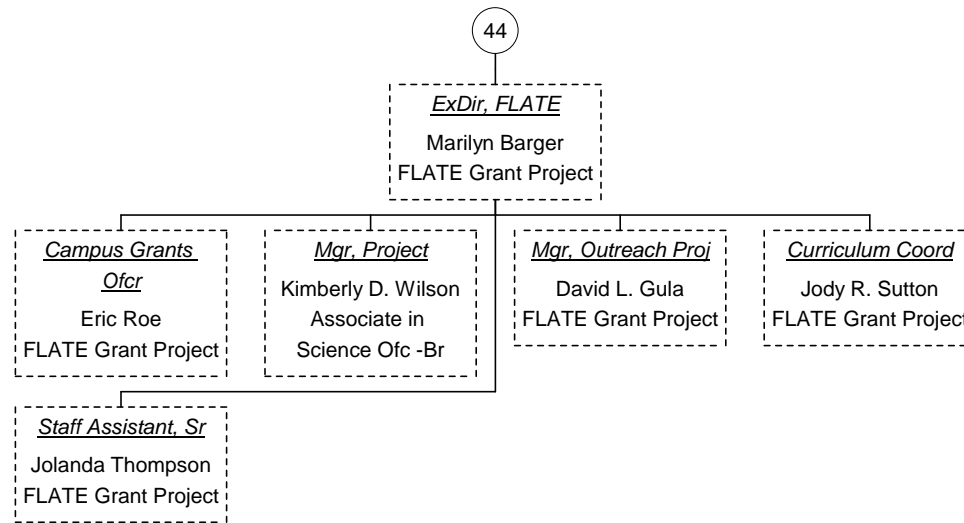

Vacant Position  
 Cabinet Position



**Mgr, CASS Project As of  
10/22/2008**

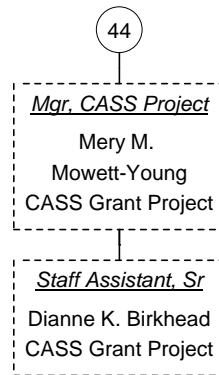

Vacant Position  
Cabinet Position



**Dean, Student Svcs As of  
10/22/2008**

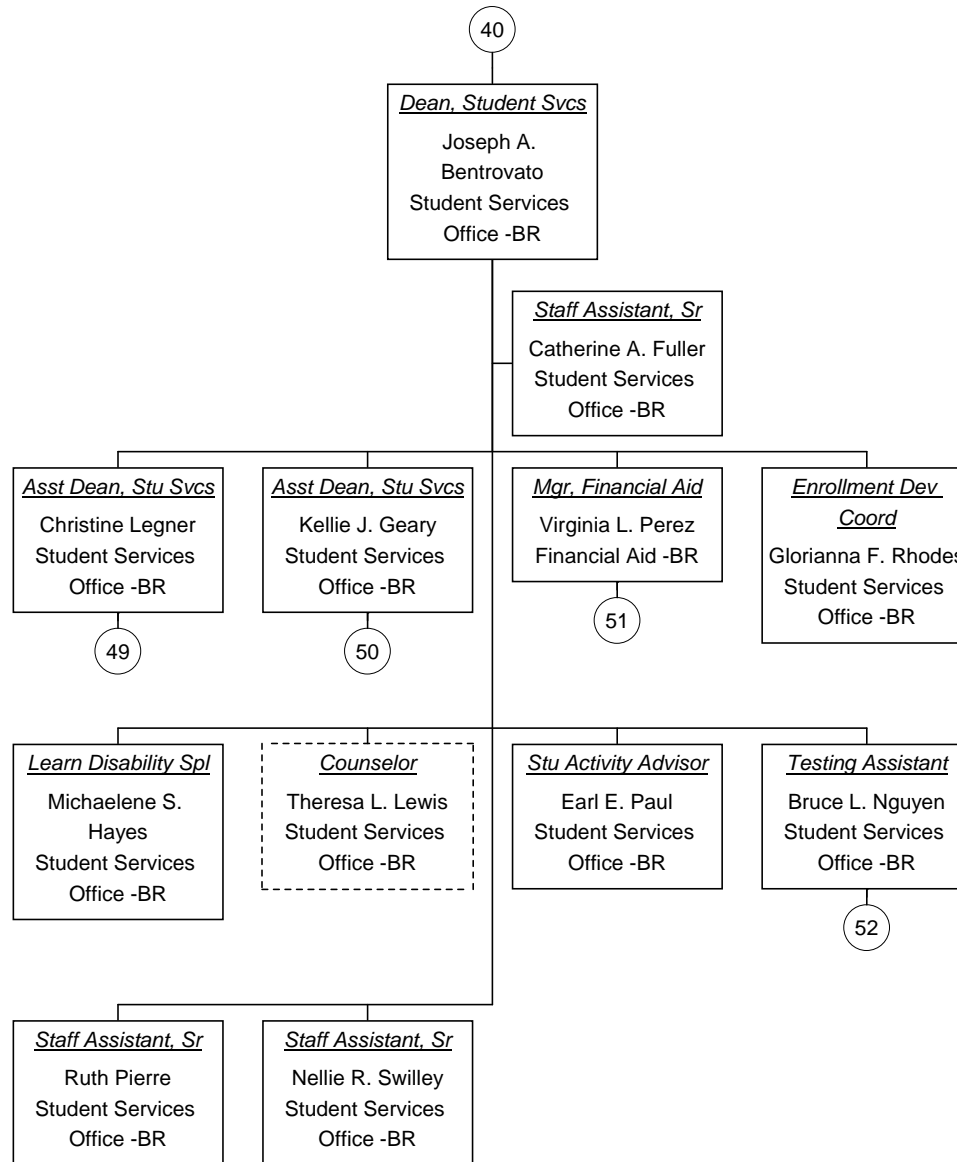

Vacant Position  
 Cabinet Position



**Asst Dean, Stu Svcs As of  
10/22/2008**

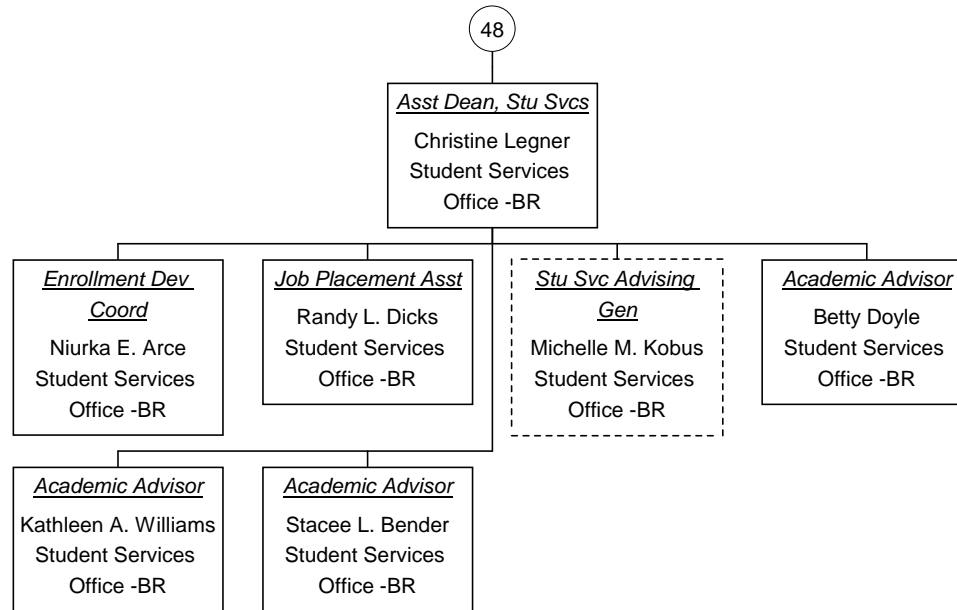

Vacant Position  
 Cabinet Position



**Asst Dean, Stu Svcs As of  
10/22/2008**

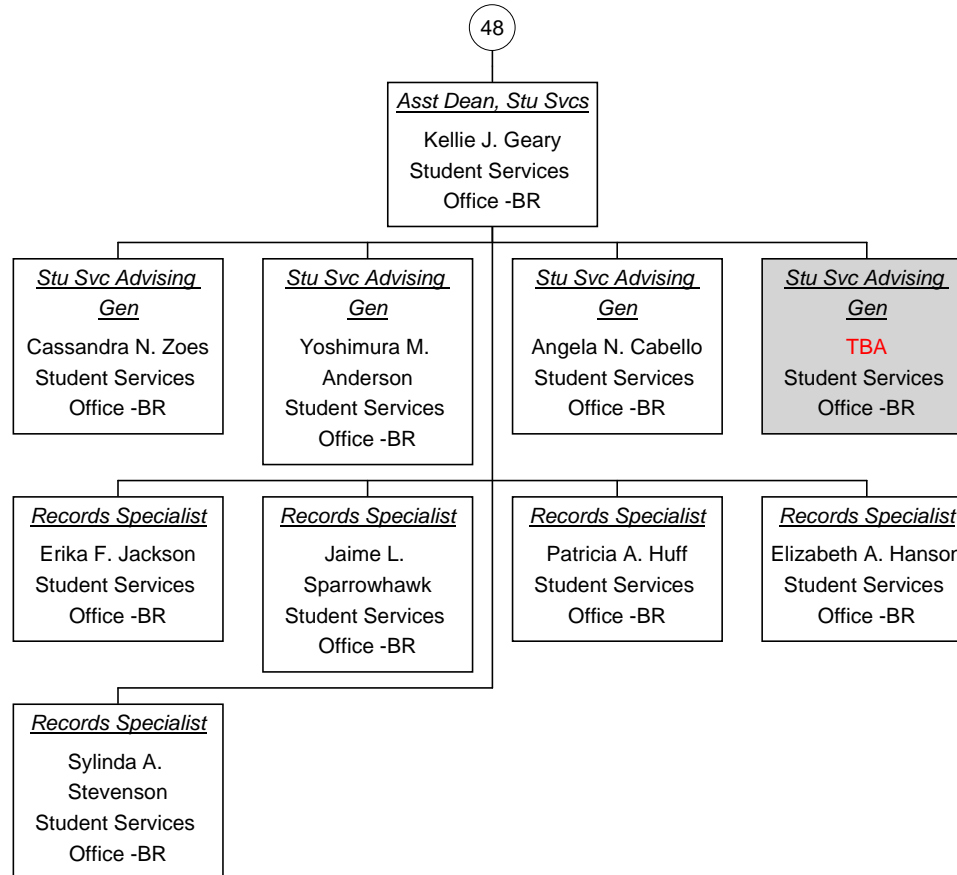

Vacant Position  
 Cabinet Position



### Mgr, Financial Aid As of 10/22/2008

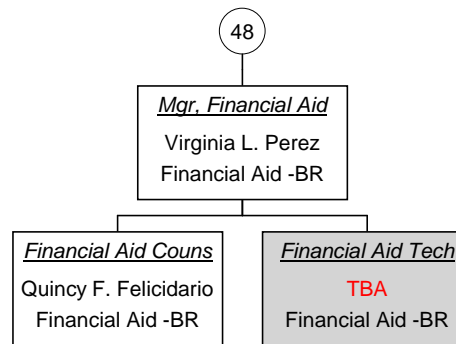

■ Vacant Position  
■ Cabinet Position



### Testing Assistant As of 10/22/2008

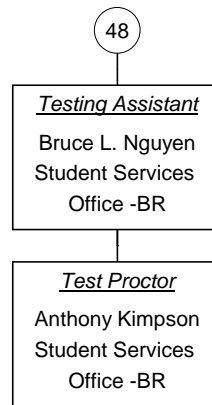

■ Vacant Position  
■ Cabinet Position



Mgr, Facilities As of 10/22/2008

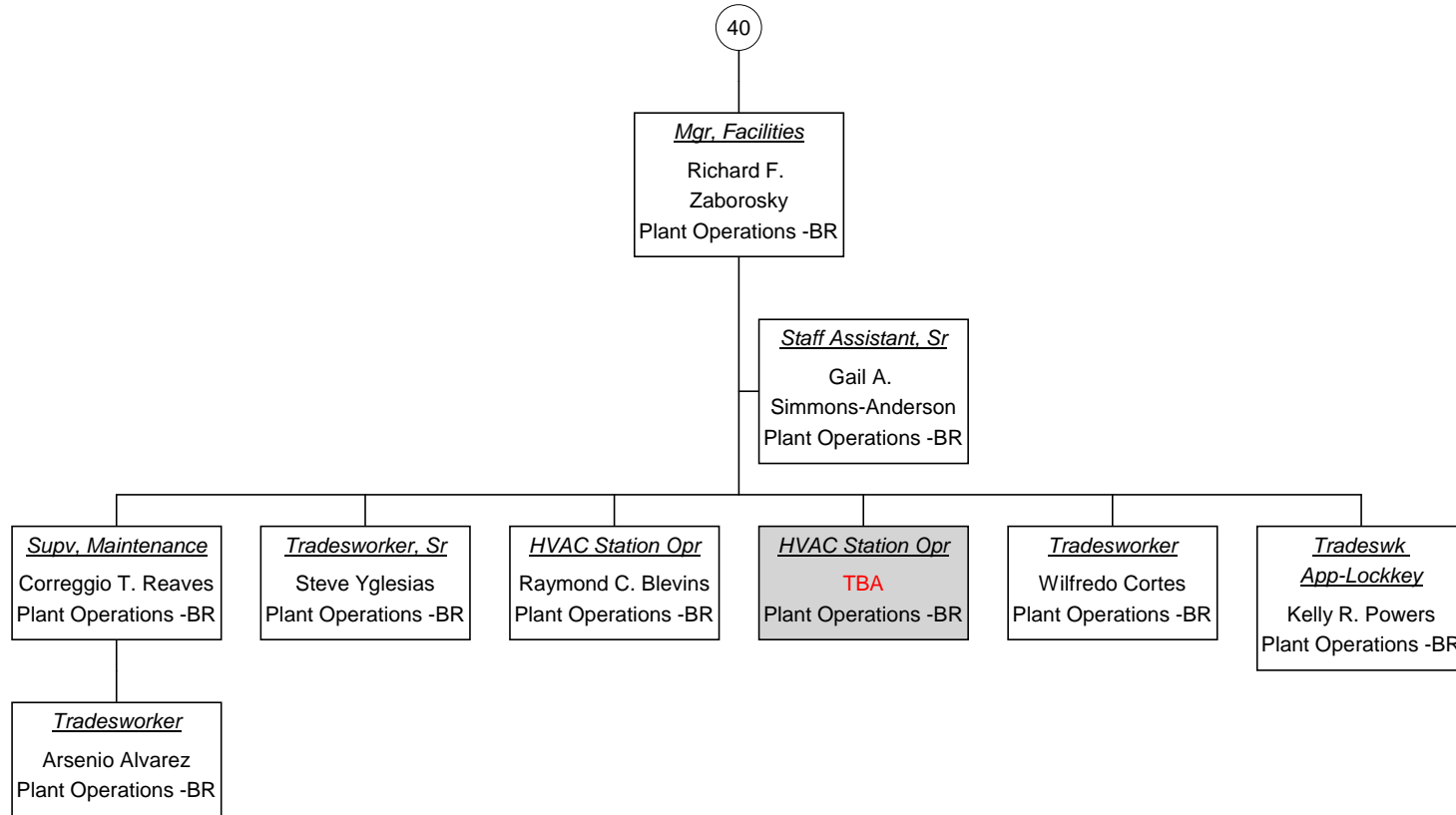

Vacant Position  
 Cabinet Position



**Campus President, PC As of 10/22/2008**

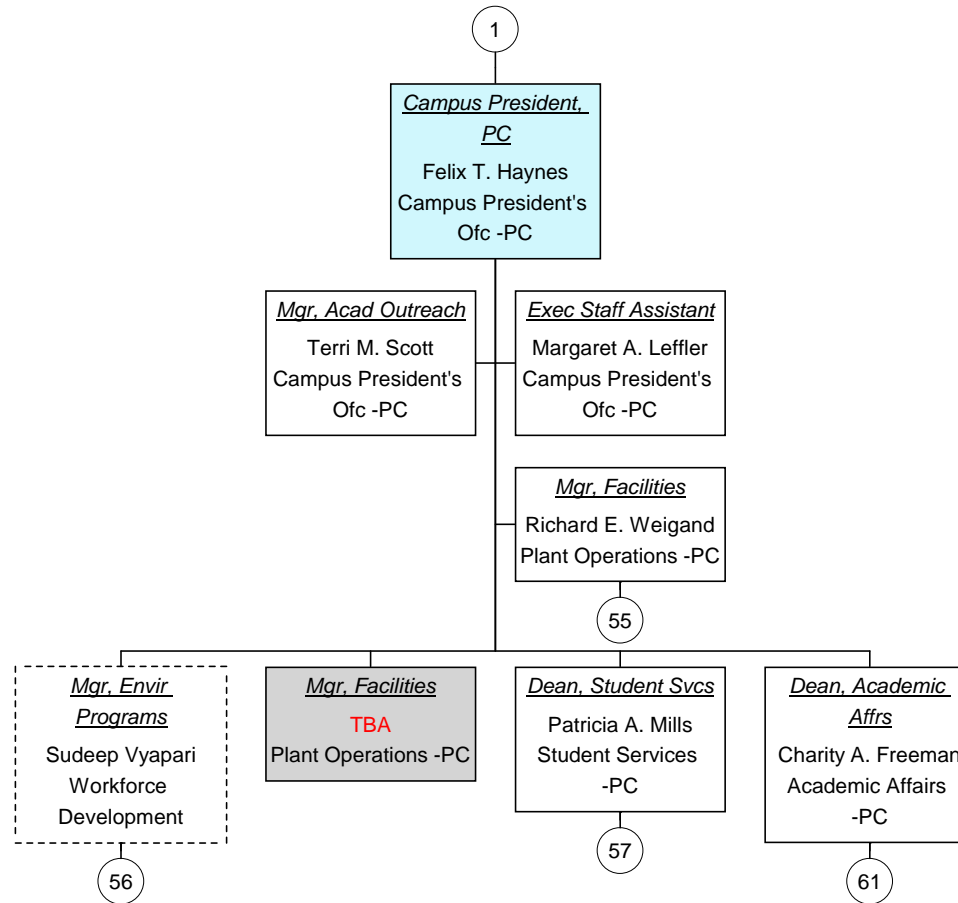

Vacant Position  
 Cabinet Position



Mgr, Facilities As of 10/22/2008

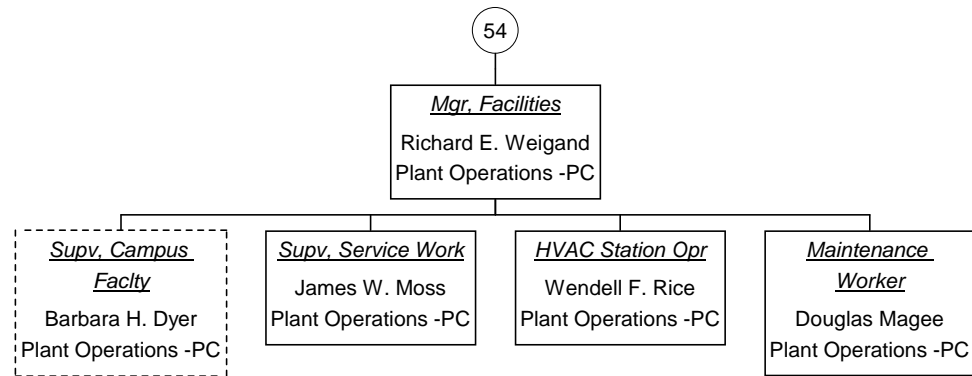

Vacant Position  
Cabinet Position



**Mgr, Envir Programs As of  
10/22/2008**

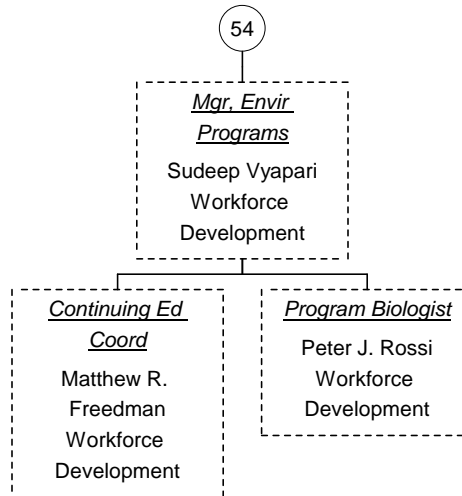

■ Vacant Position  
■ Cabinet Position



**Dean, Student Svcs As of  
10/22/2008**

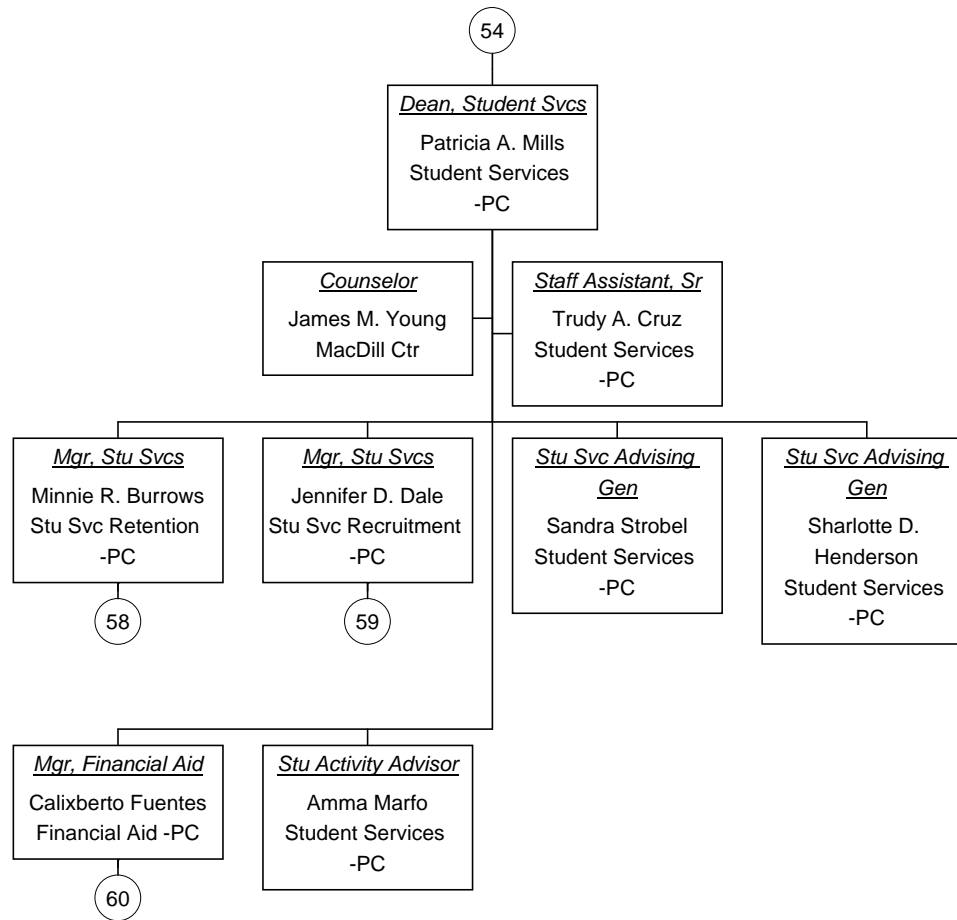

Vacant Position  
 Cabinet Position



Mgr, Stu Svcs As of 10/22/2008

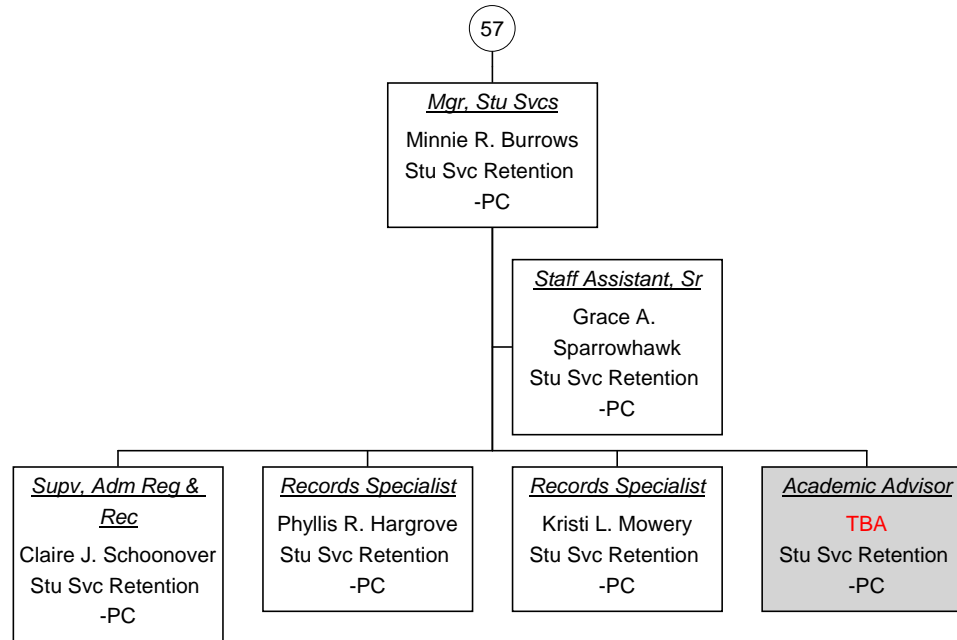

Vacant Position  
Cabinet Position



**Mgr, Stu Svcs As of 10/22/2008**

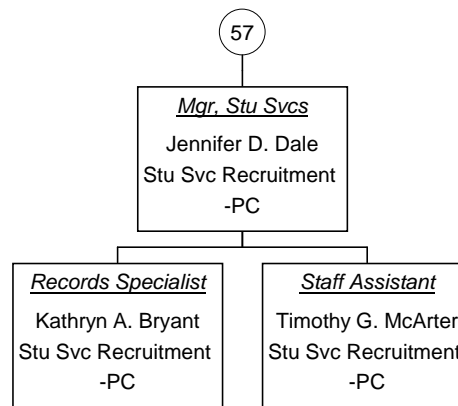

■ Vacant Position  
■ Cabinet Position



**Mgr, Financial Aid As of  
10/22/2008**

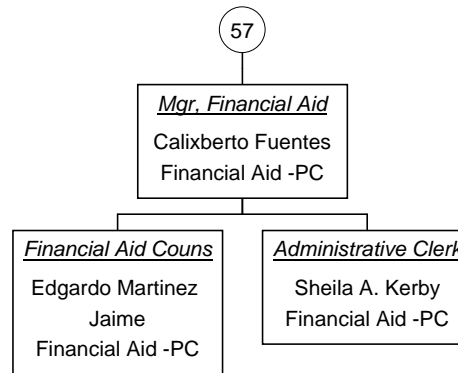

■ Vacant Position  
■ Cabinet Position

Dean, Academic Affrs As of  
10/22/2008

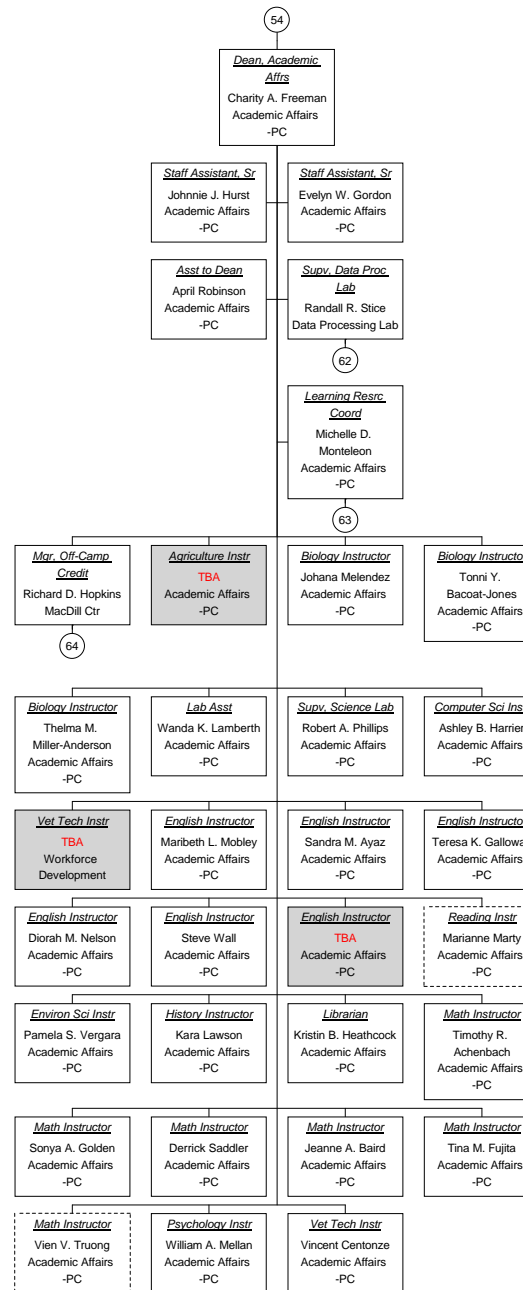

Vacant Position  
Cabinet Position  
Dotted border = Temp Position



**Supv, Data Proc Lab As of  
10/22/2008**

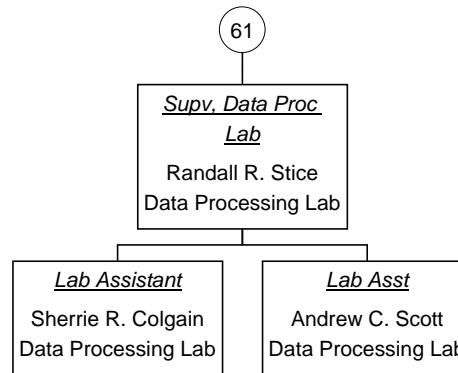

■ Vacant Position  
■ Cabinet Position



### Learning Resrc Coord As of 10/22/2008

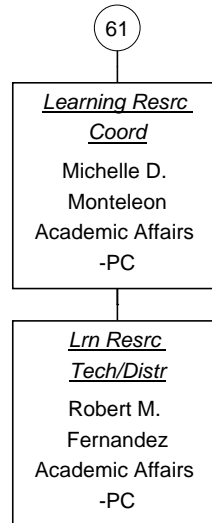

■ Vacant Position  
■ Cabinet Position



**Mgr, Off-Camp Credit As of  
10/22/2008**

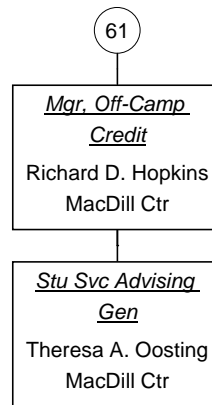

■ Vacant Position  
■ Cabinet Position



**Campus President, SS As of 10/22/2008**

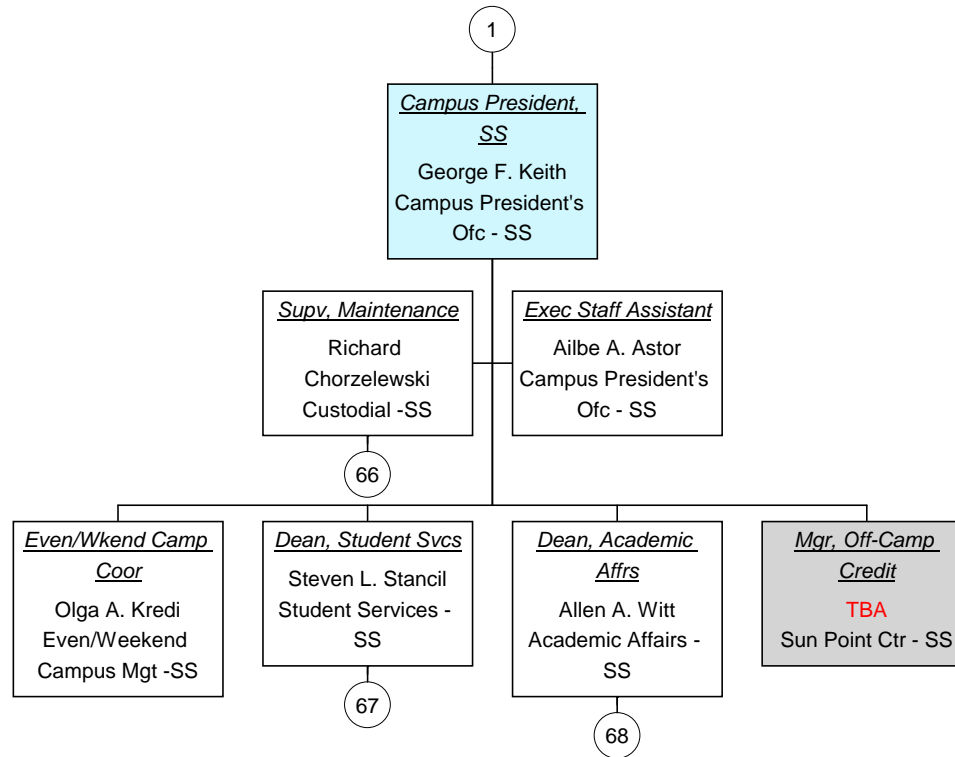

Vacant Position  
 Cabinet Position



**Supv, Maintenance As of  
10/22/2008**

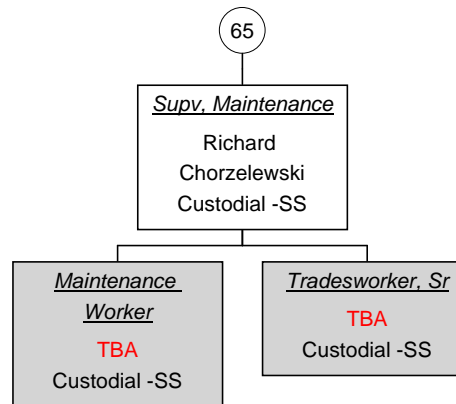

■ Vacant Position  
■ Cabinet Position



**Dean, Student Svcs As of  
10/22/2008**

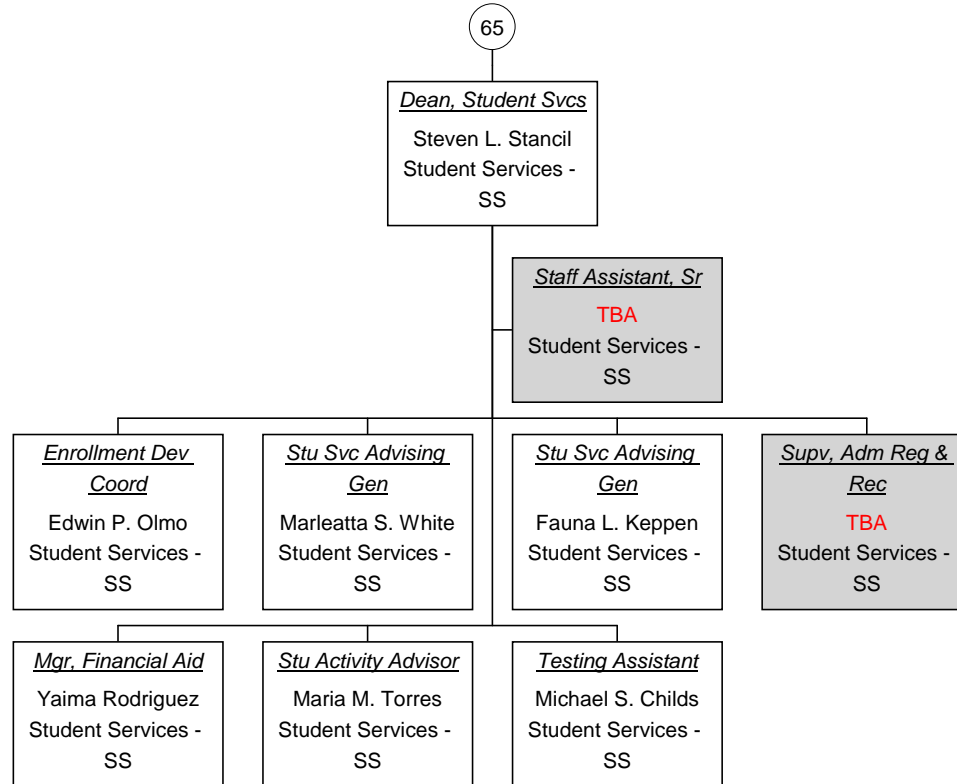

Vacant Position  
 Cabinet Position



Dean, Academic Affrs As of  
10/22/2008

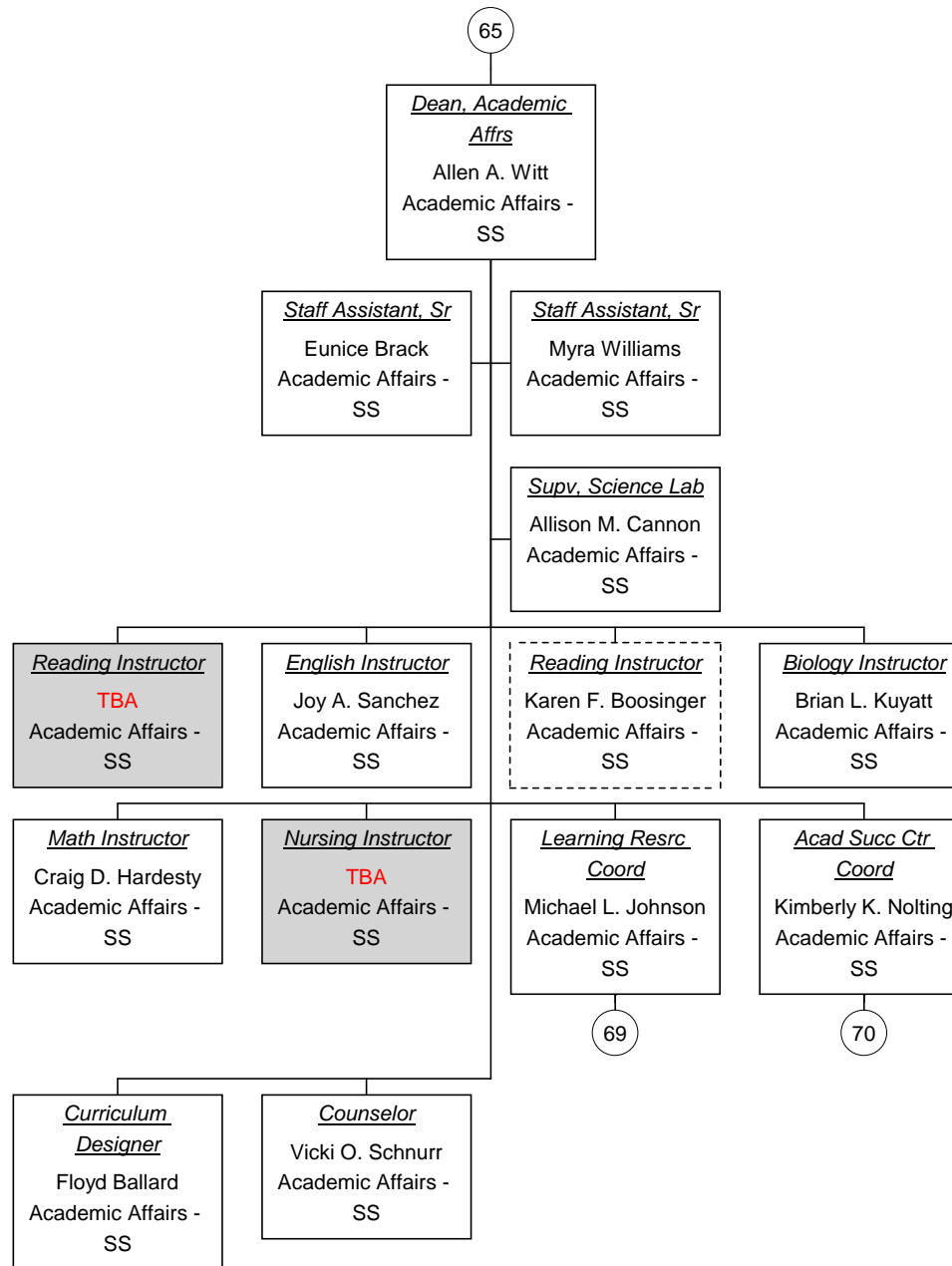

Vacant Position  
 Cabinet Position



Learning Resrc Coord As of  
10/22/2008

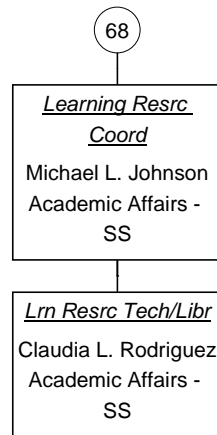

Vacant Position  
Cabinet Position



**Acad Succ Ctr Coord As of  
10/22/2008**

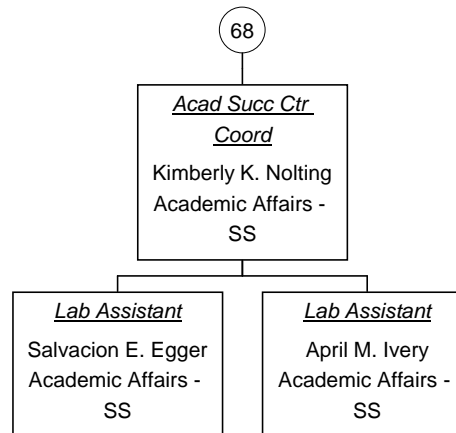

■ Vacant Position  
■ Cabinet Position



**VP, Stu Svc Enr Mgt As of  
10/22/2008**

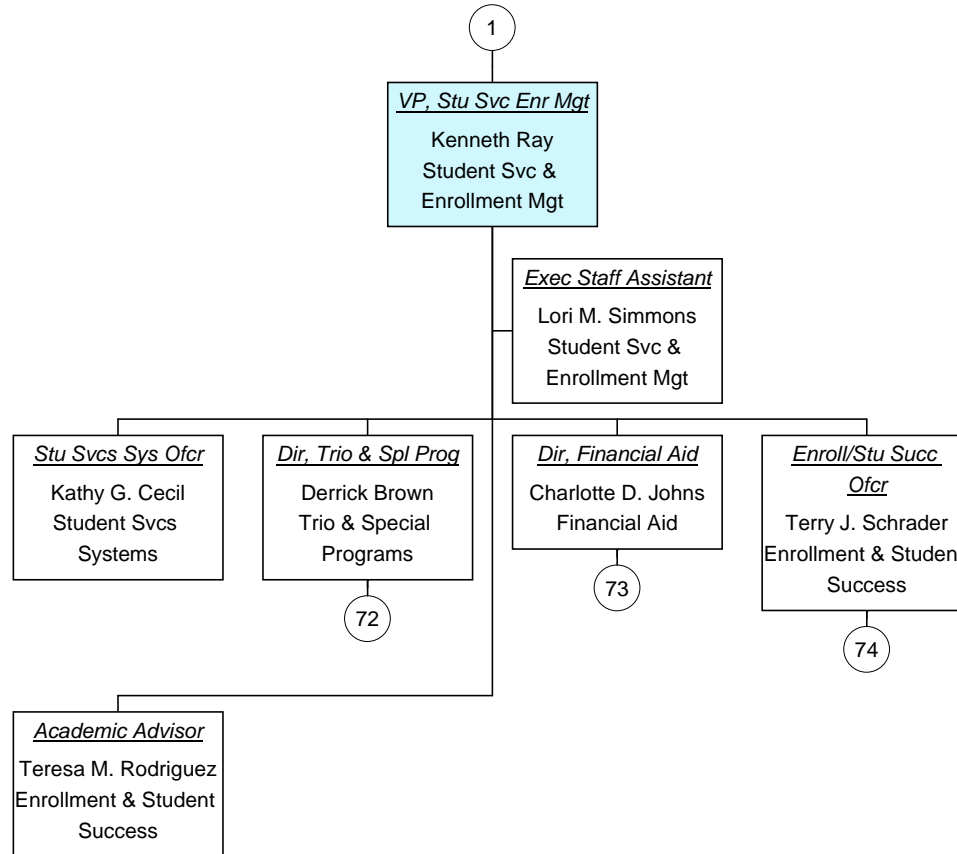

Vacant Position  
 Cabinet Position



Dir, Trio & Spl Prog As of  
10/22/2008

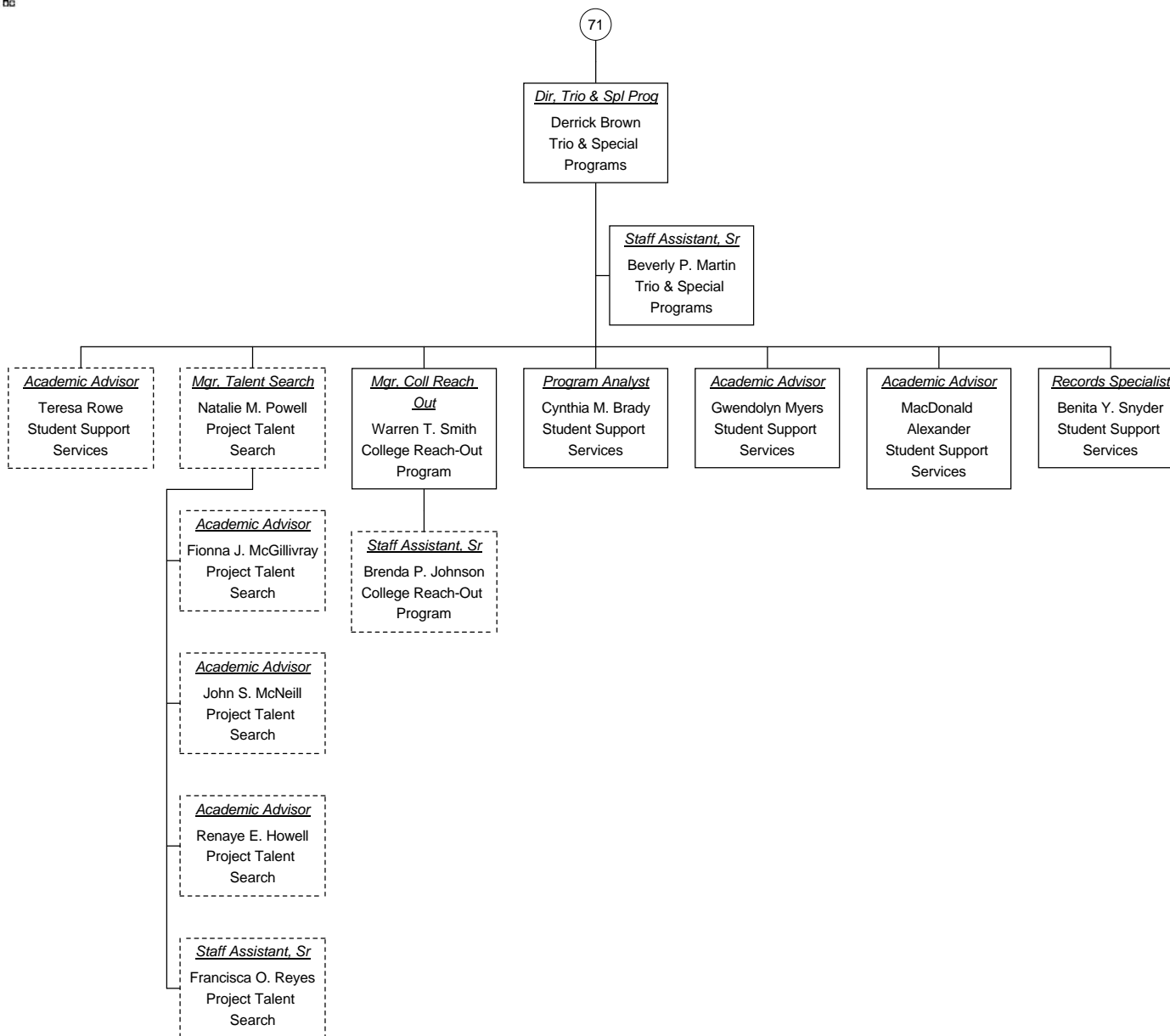

Vacant Position  
 Cabinet Position



**Dir, Financial Aid As of  
10/22/2008**

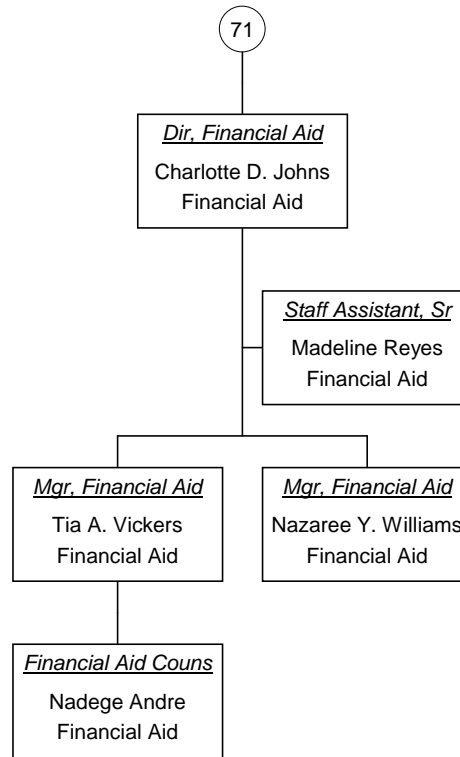

■ Vacant Position  
■ Cabinet Position



**Enroll/Stu Succ Ofcr As of  
10/22/2008**

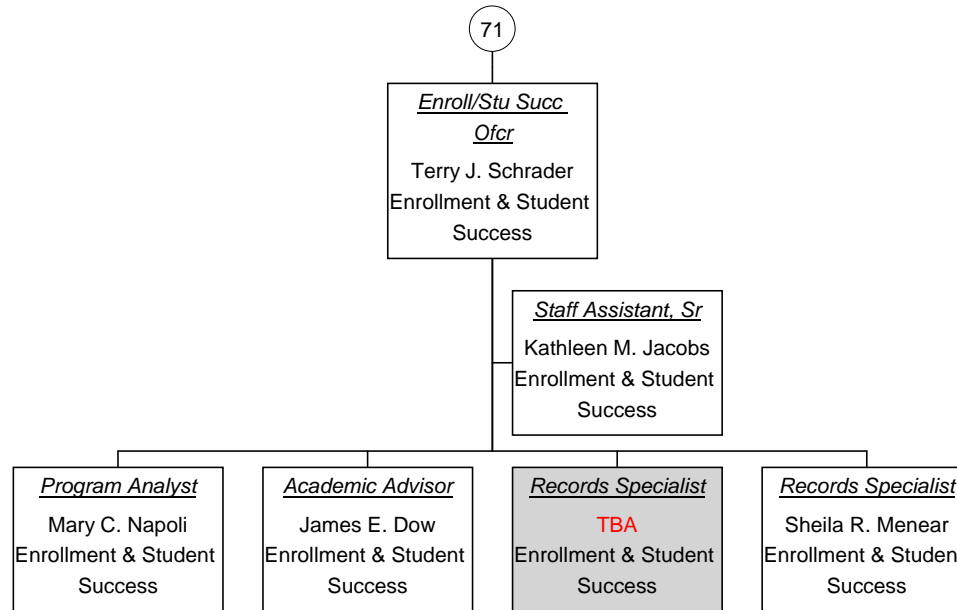

Vacant Position  
 Cabinet Position



VP, Acad Affrs As of 10/22/2008

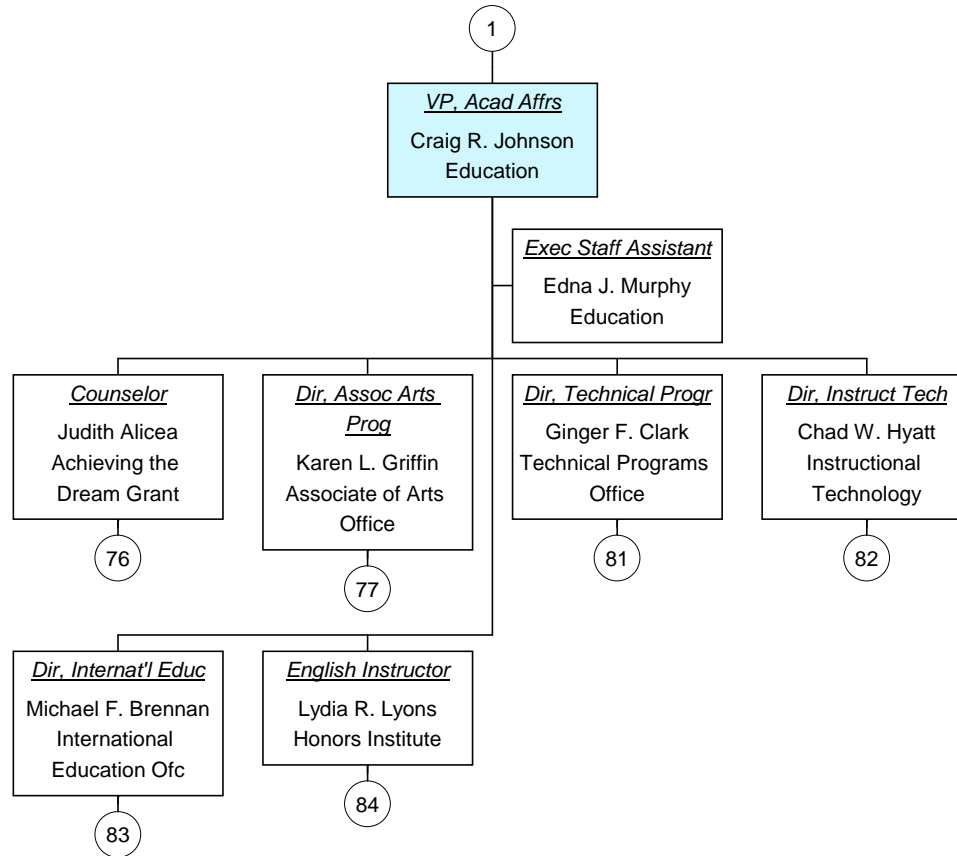

Vacant Position  
 Cabinet Position



Counselor As of 10/22/2008

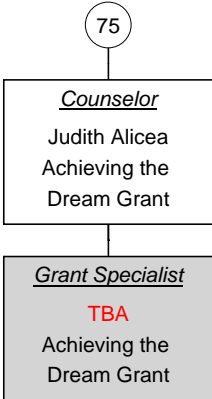

Vacant Position  
 Cabinet Position



Dir, Assoc Arts Prog As of 10/22/2008

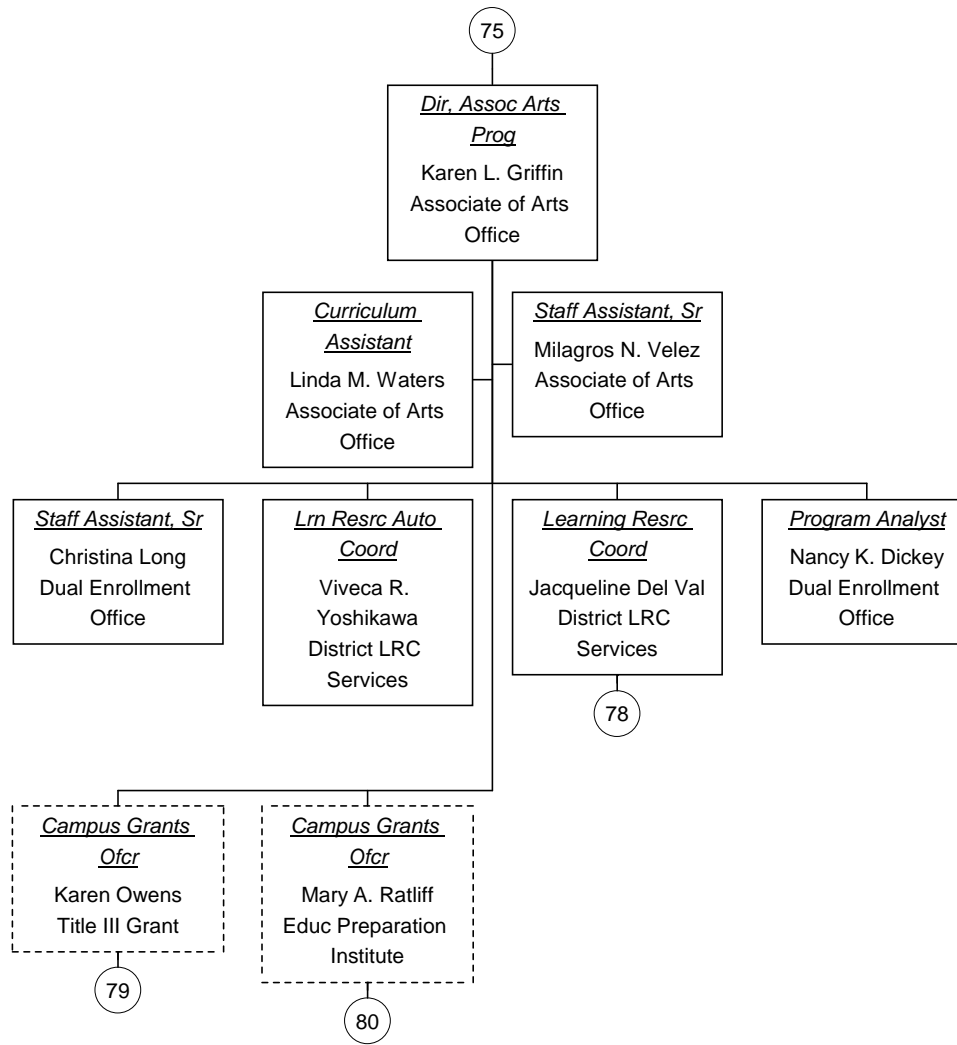

Vacant Position  
 Cabinet Position



Learning Resrc Coord As of  
10/22/2008

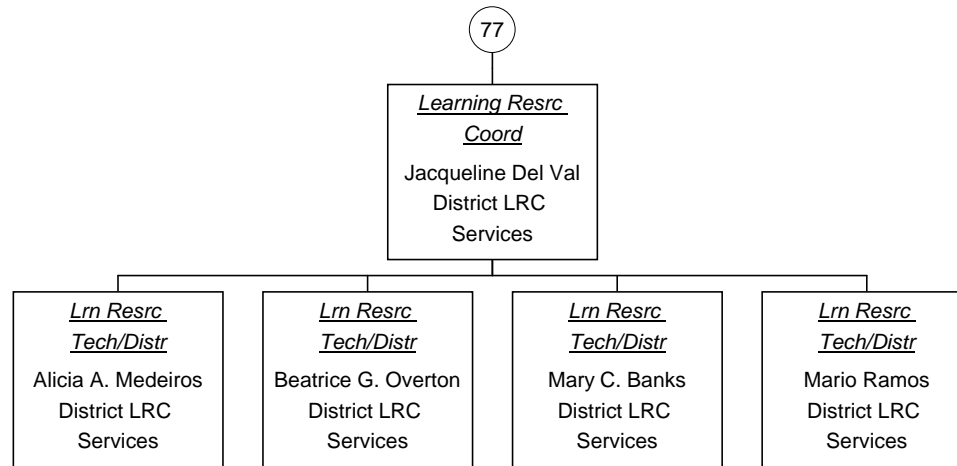

■ Vacant Position  
■ Cabinet Position



**Campus Grants Ofcr As of  
10/22/2008**

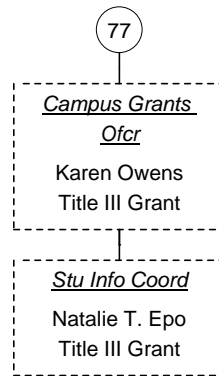

■ Vacant Position  
■ Cabinet Position



**Campus Grants Ofcr As of  
10/22/2008**

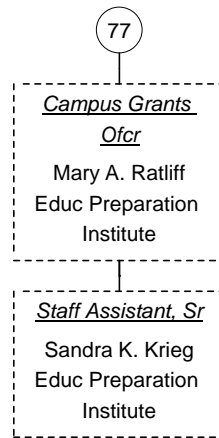

■ Vacant Position  
■ Cabinet Position

**Dir, Technical Progr As of  
10/22/2008**

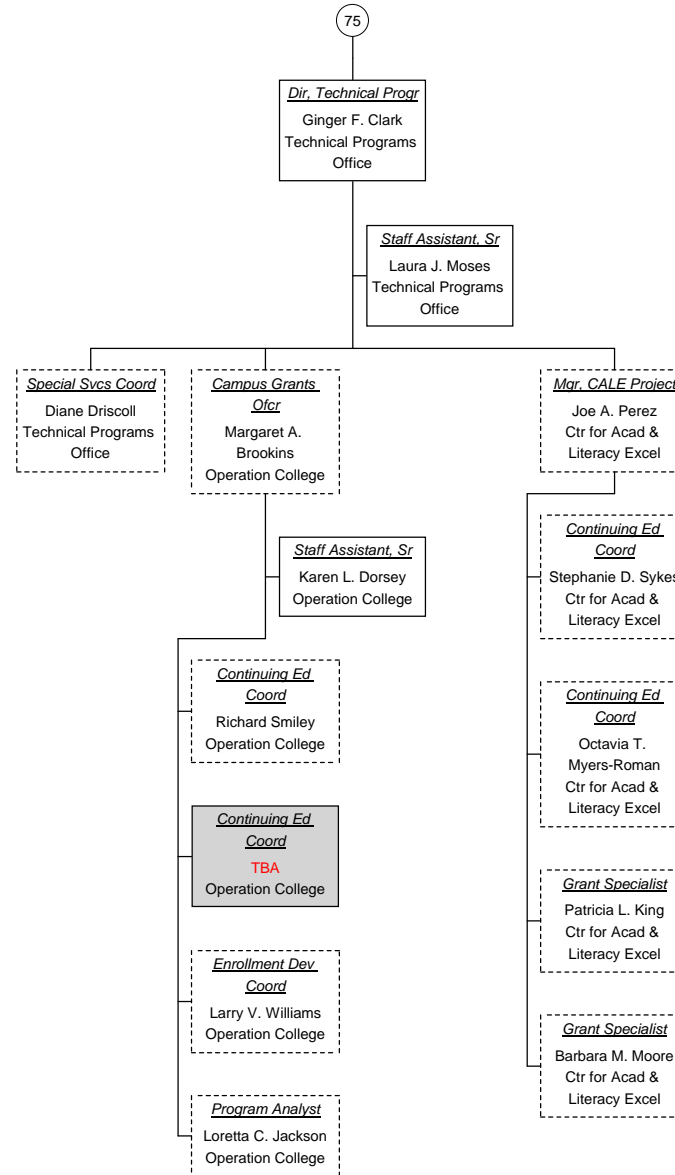

Vacant Position  
 Cabinet Position



Dir, Instruct Tech As of 10/22/2008

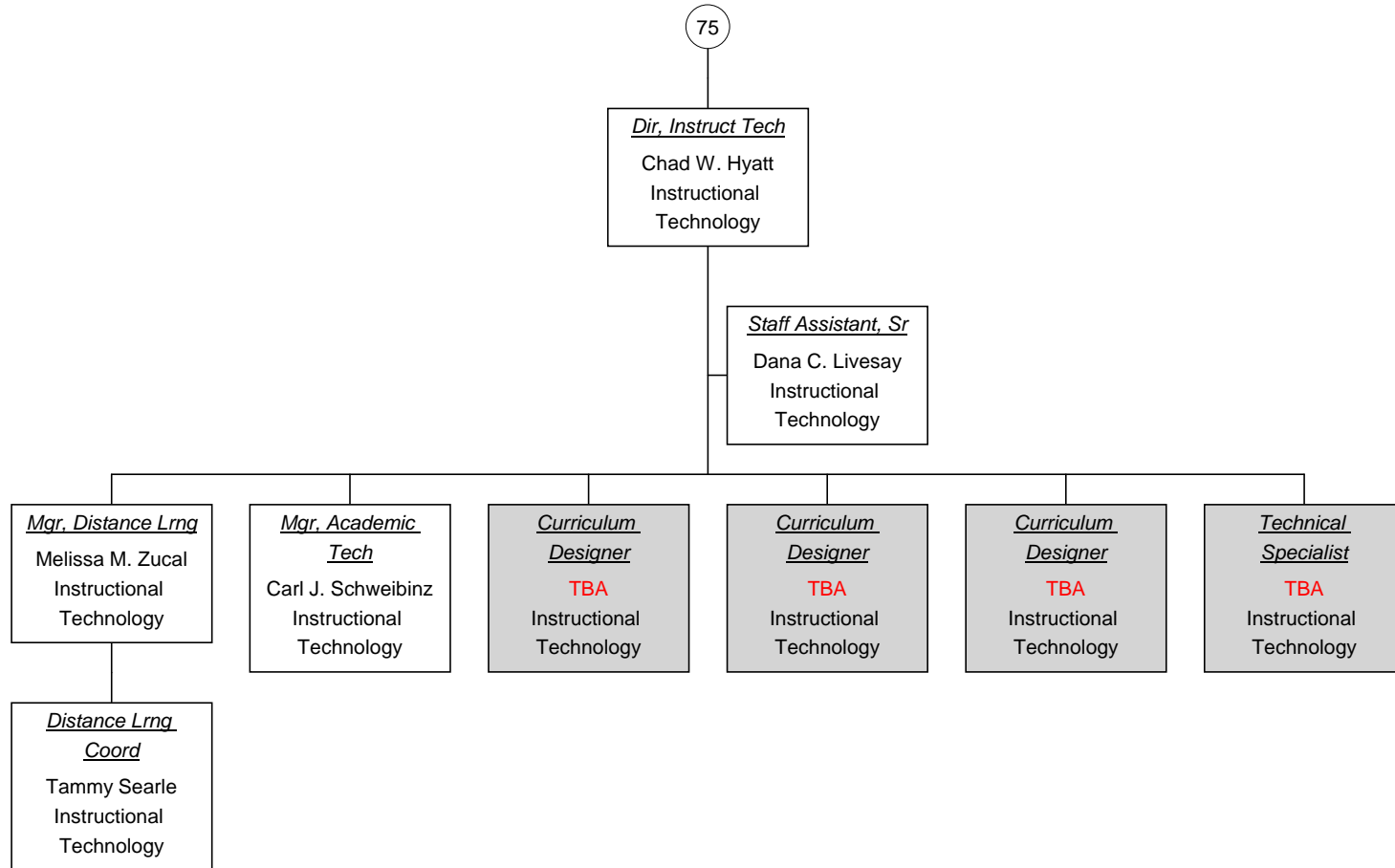

Vacant Position  
 Cabinet Position



Dir, Internat'l Educ As of 10/22/2008

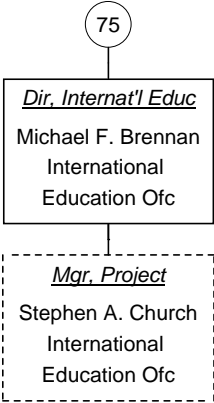

Vacant Position  
 Cabinet Position



### English Instructor As of 10/22/2008

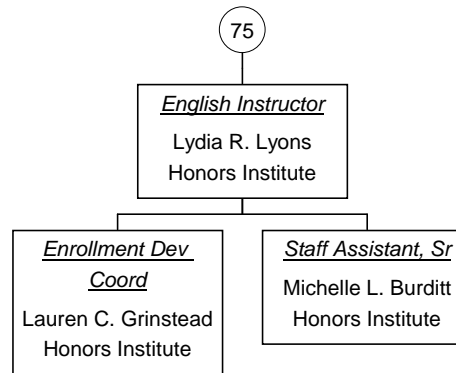

■ Vacant Position  
■ Cabinet Position



**VP, Admin / CFO As of 10/22/2008**

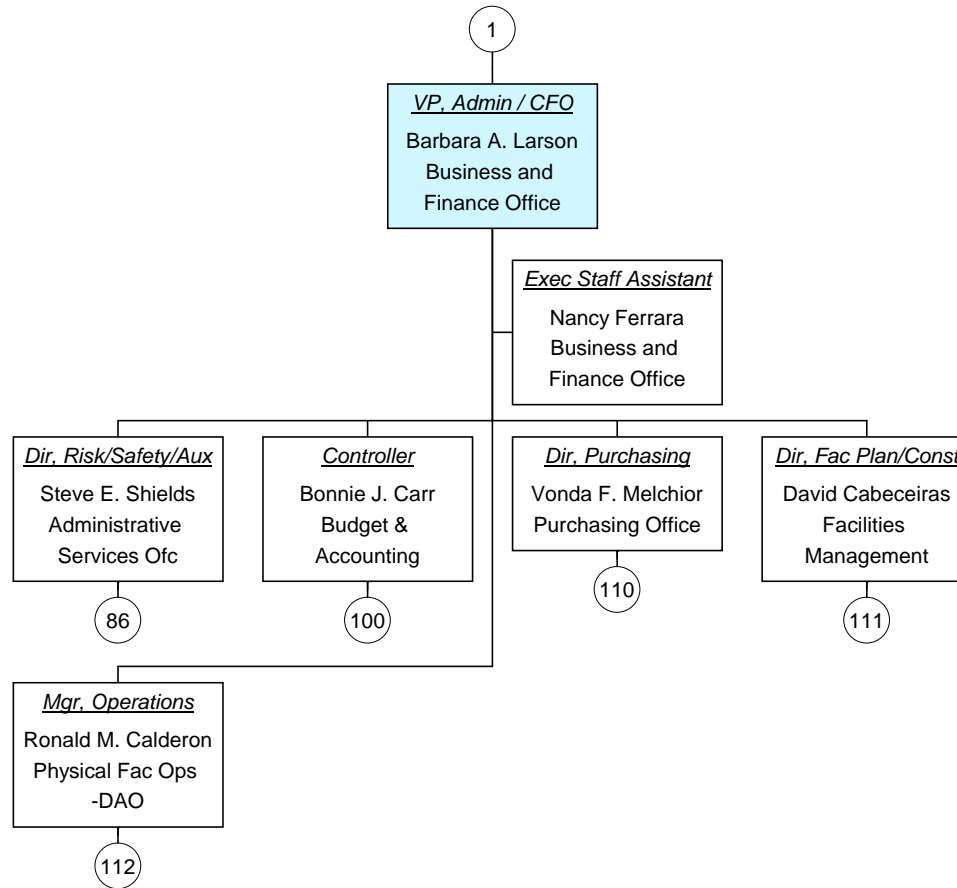

Vacant Position  
 Cabinet Position



**Dir, Risk/Safety/Aux As of  
10/22/2008**

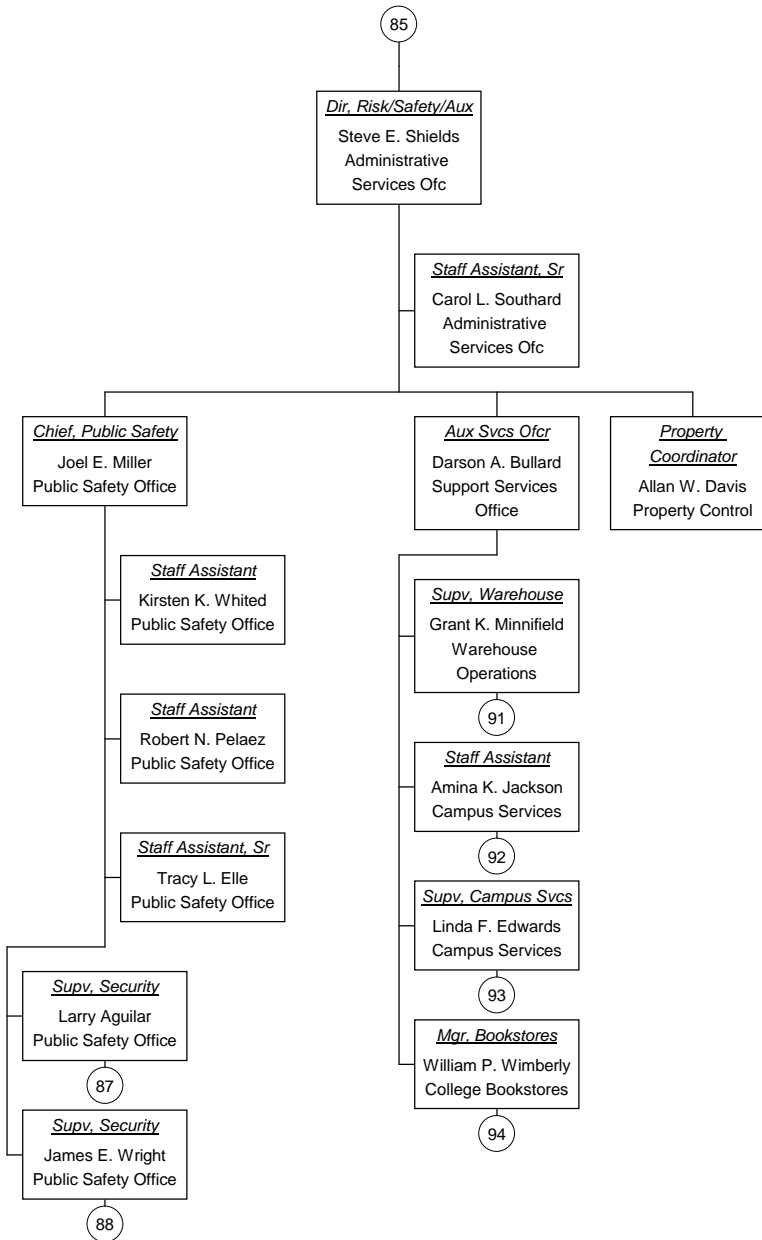

Vacant Position  
 Cabinet Position



**Supv, Security As of 10/22/2008**

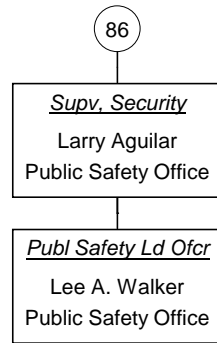

Vacant Position  
Cabinet Position



**Supv, Security As of 10/22/2008**

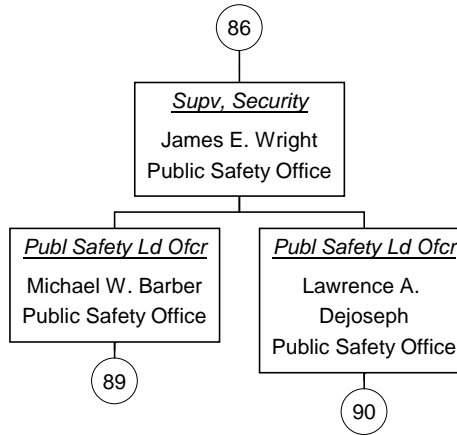

Vacant Position  
Cabinet Position



**Publ Safety Ld Ofcr As of  
10/22/2008**

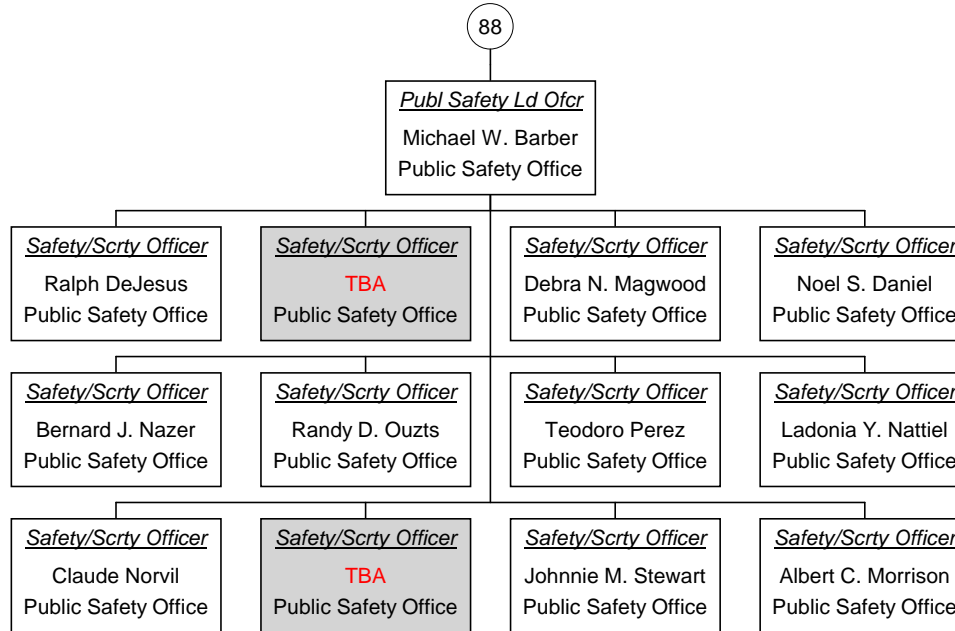

Vacant Position  
 Cabinet Position



**Publ Safety Ld Ofcr As of  
10/22/2008**

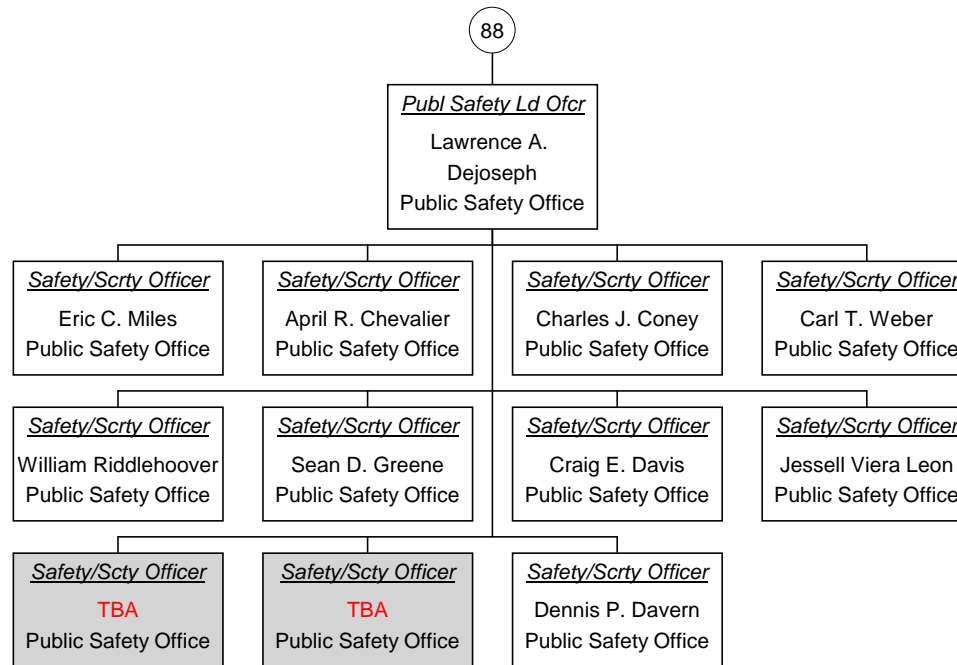

Vacant Position  
 Cabinet Position



**Supv, Warehouse As of  
10/22/2008**

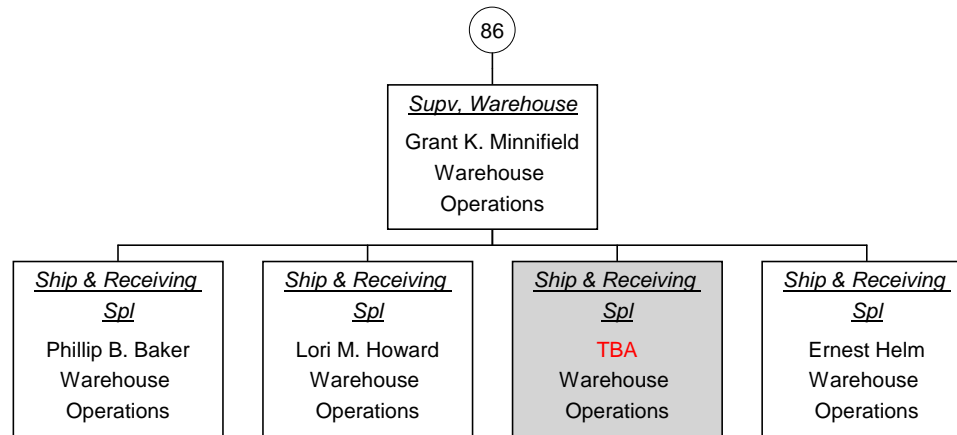

■ Vacant Position  
■ Cabinet Position



**Staff Assistant As of 10/22/2008**

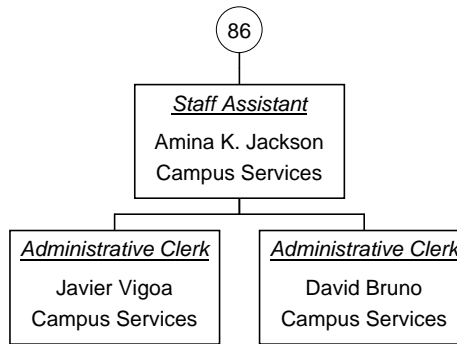

■ Vacant Position  
■ Cabinet Position



**Supv, Campus Svcs As of  
10/22/2008**

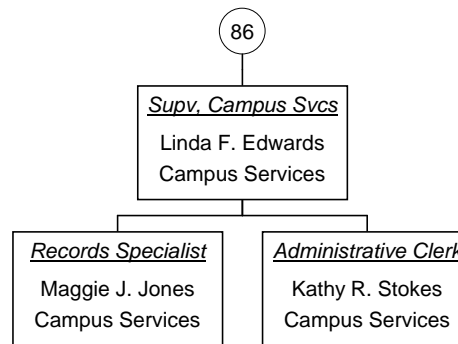

■ Vacant Position  
■ Cabinet Position



**Mgr, Bookstores As of  
10/22/2008**

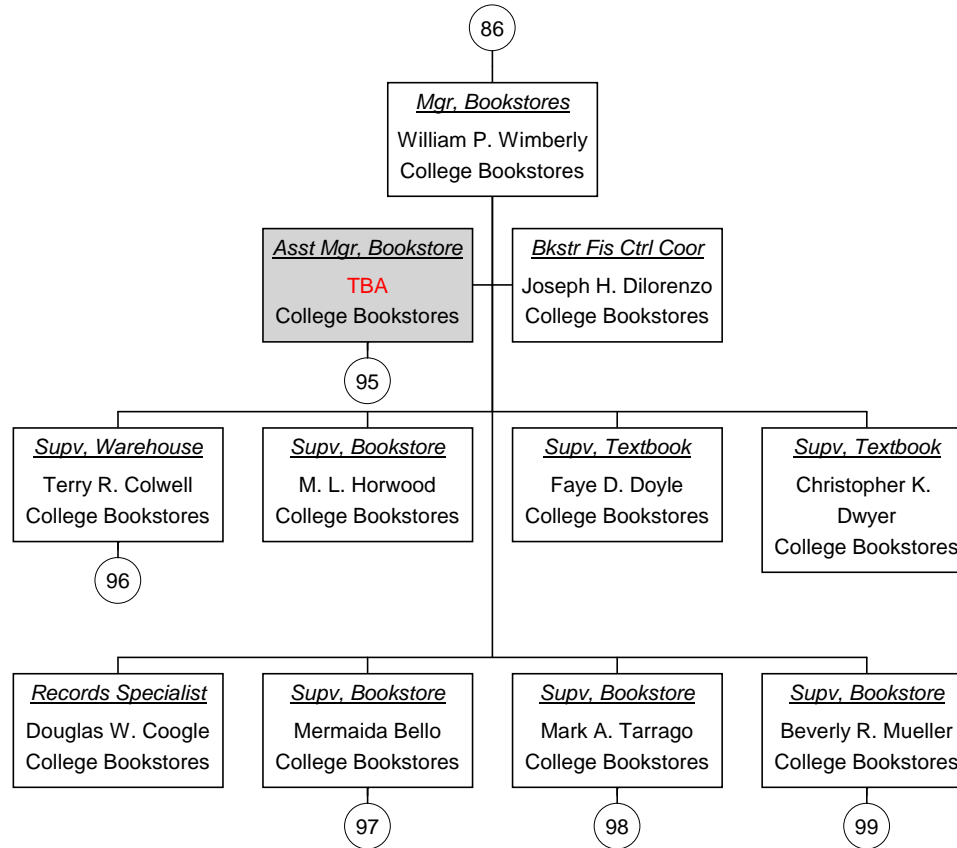

Vacant Position  
 Cabinet Position



**Asst Mgr, Bookstore As of  
10/22/2008**

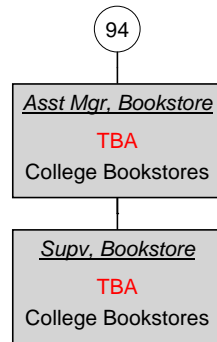

■ Vacant Position  
■ Cabinet Position



**Supv, Warehouse As of  
10/22/2008**

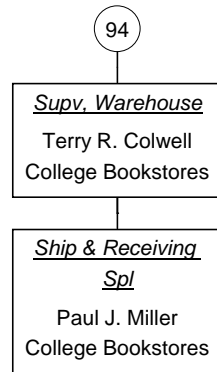

Vacant Position  
Cabinet Position



**Supv, Bookstore As of  
10/22/2008**

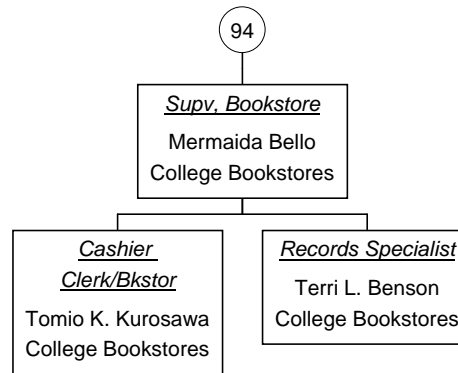

■ Vacant Position  
■ Cabinet Position



**Supv, Bookstore As of  
10/22/2008**

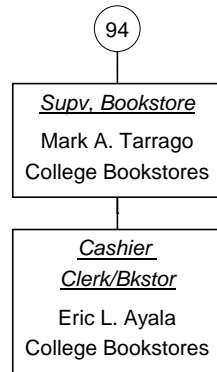

Vacant Position  
Cabinet Position



**Supv, Bookstore As of  
10/22/2008**

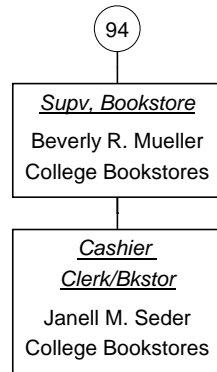

Vacant Position  
Cabinet Position



Controller As of 10/22/2008

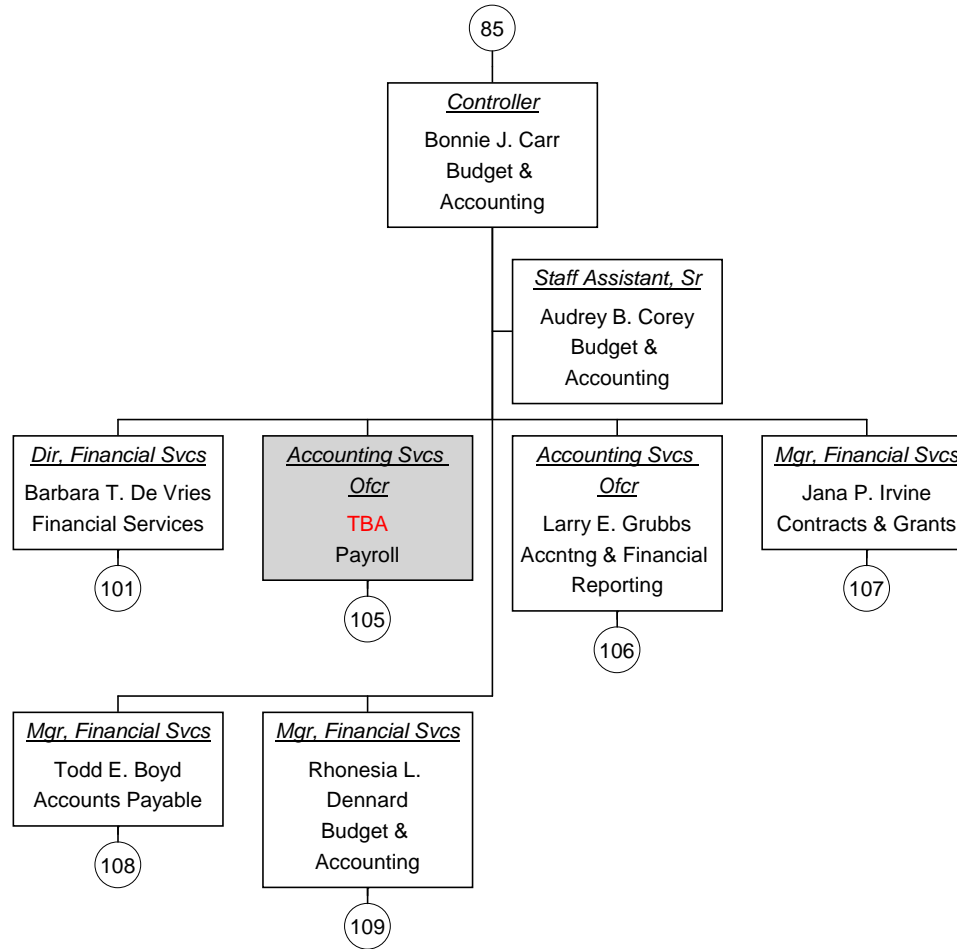

Vacant Position  
 Cabinet Position



**Dir, Financial Svcs As of 10/22/2008**

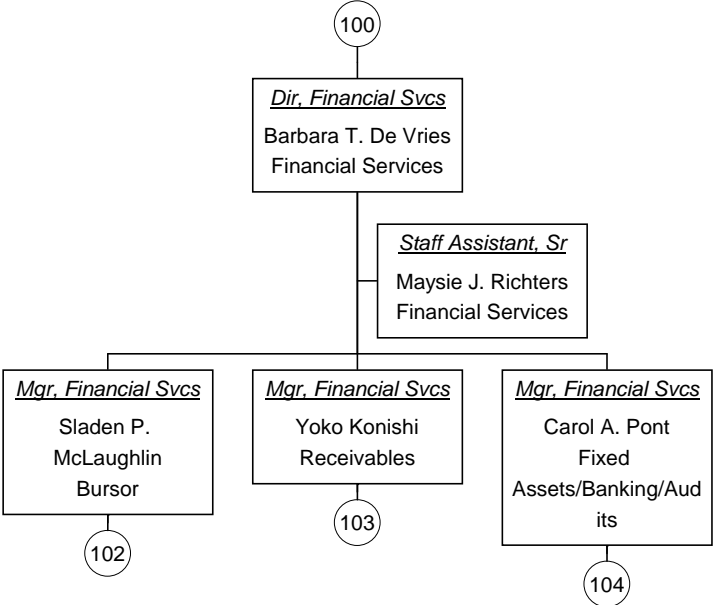

Vacant Position  
 Cabinet Position



**Mgr, Financial Svcs As of  
10/22/2008**

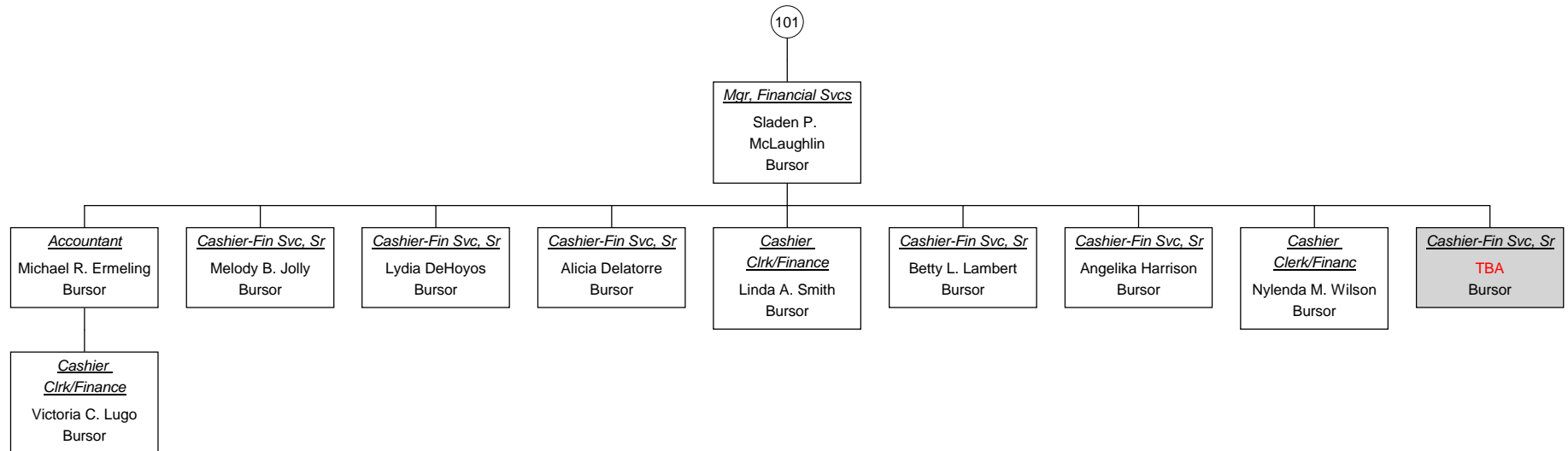

Vacant Position  
 Cabinet Position



**Mgr, Financial Svcs As of  
10/22/2008**

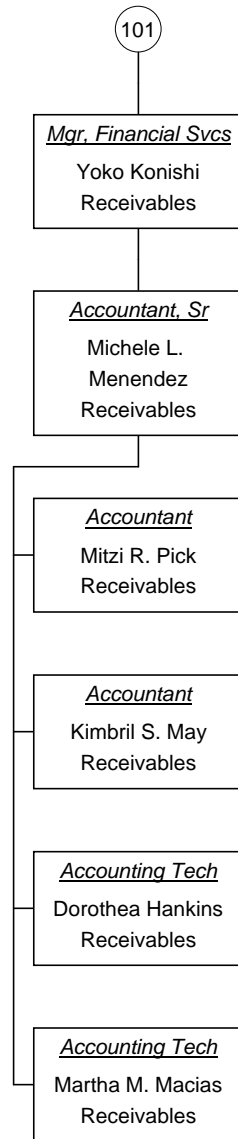

■ Vacant Position  
■ Cabinet Position



**Mgr, Financial Svcs As of  
10/22/2008**

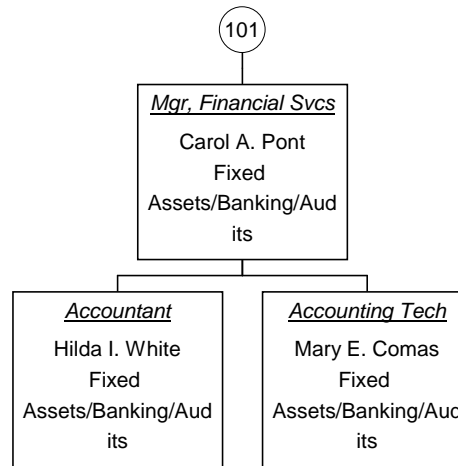

■ Vacant Position  
■ Cabinet Position



### Accounting Svcs Ofcr As of 10/22/2008

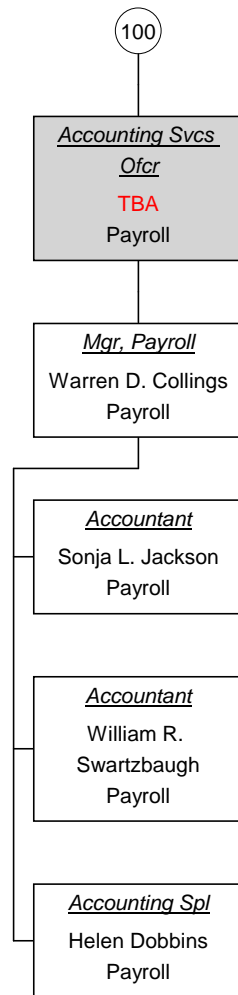

Vacant Position  
Cabinet Position



**Accounting Svcs Ofcr As of  
10/22/2008**

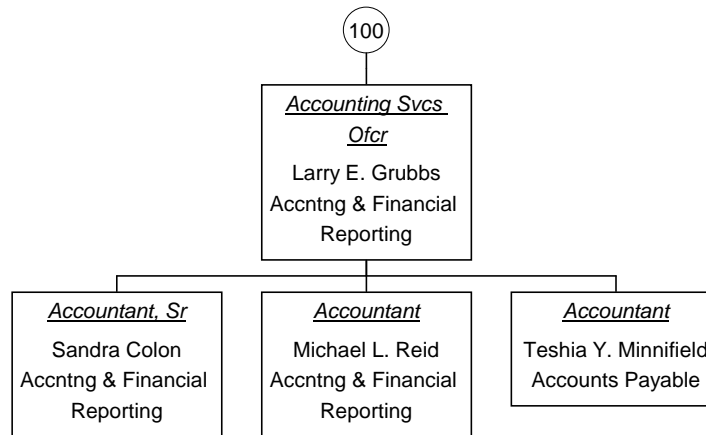

■ Vacant Position  
■ Cabinet Position



**Mgr, Financial Svcs As of  
10/22/2008**

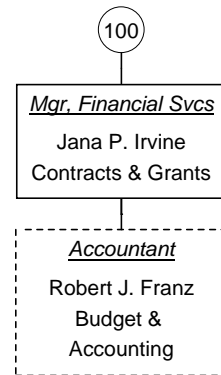

■ Vacant Position  
■ Cabinet Position



**Mgr, Financial Svcs As of  
10/22/2008**

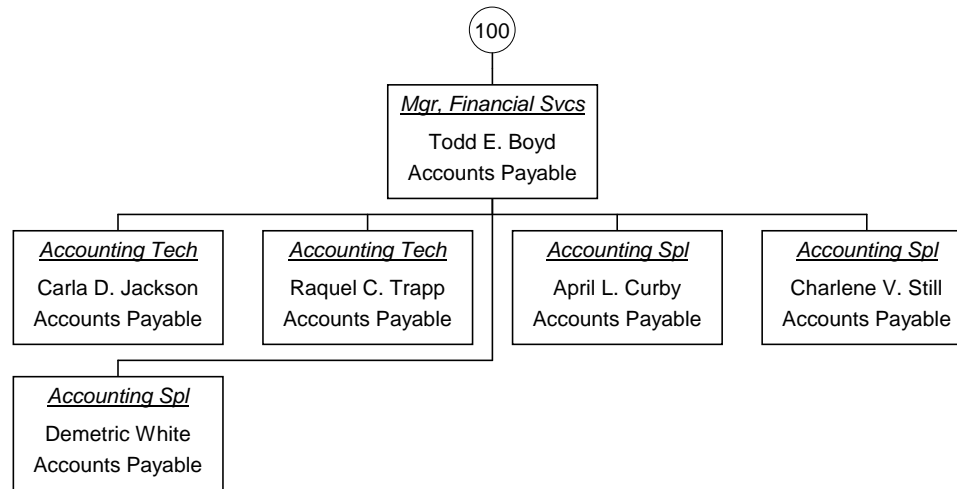

■ Vacant Position  
■ Cabinet Position



**Mgr, Financial Svcs As of  
10/22/2008**

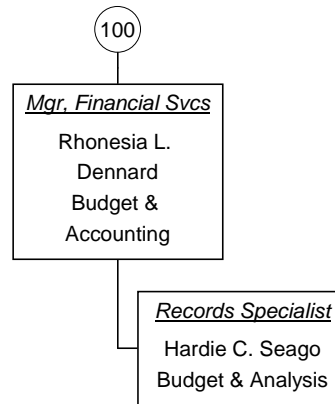

Vacant Position  
Cabinet Position



**Dir, Purchasing As of  
10/22/2008**

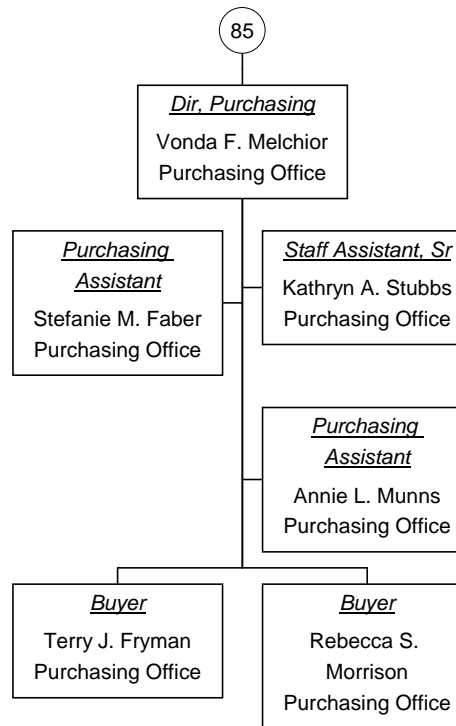

■ Vacant Position  
■ Cabinet Position

Dir, Fac Plan/Const As of 10/22/2008

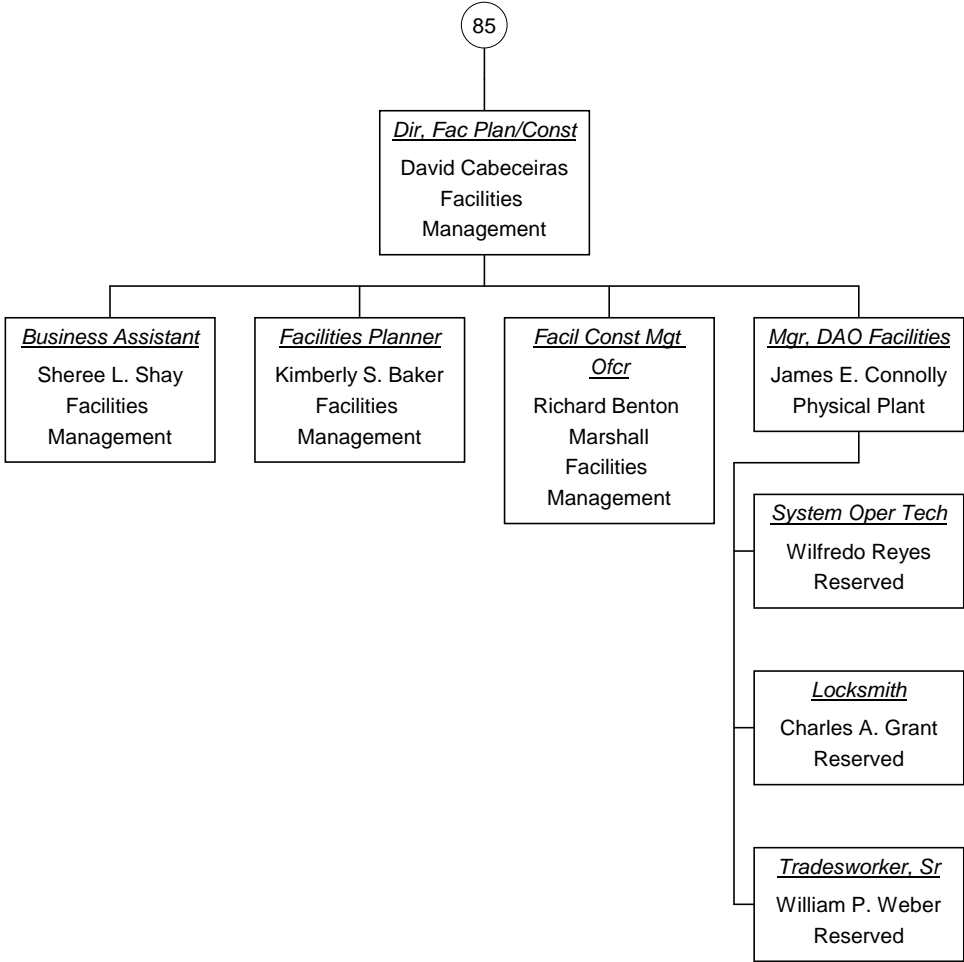

Vacant Position  
 Cabinet Position

Mgr, Operations As of  
10/22/2008

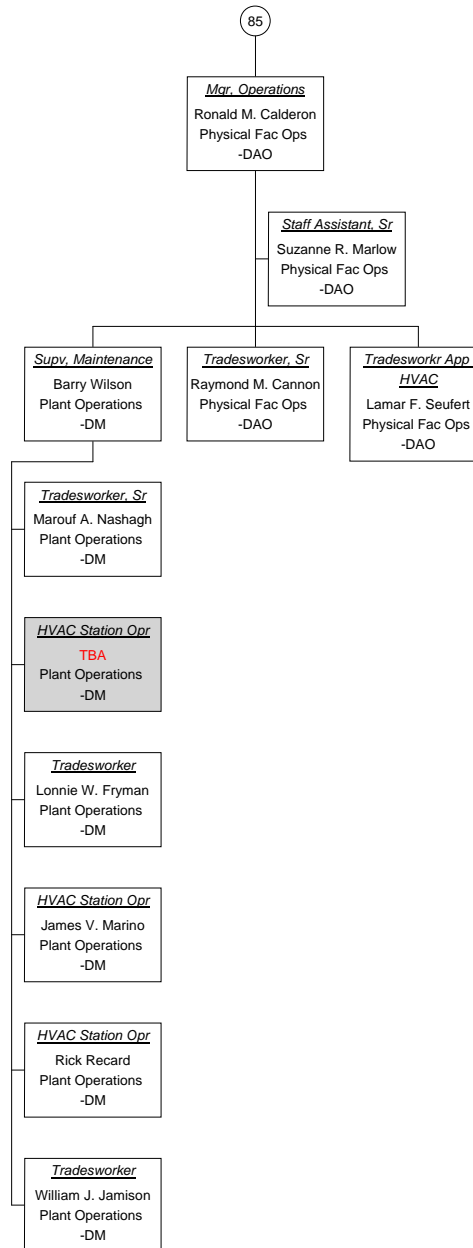

Vacant Position  
Cabinet Position



**VP, Info Technology As of  
10/22/2008**

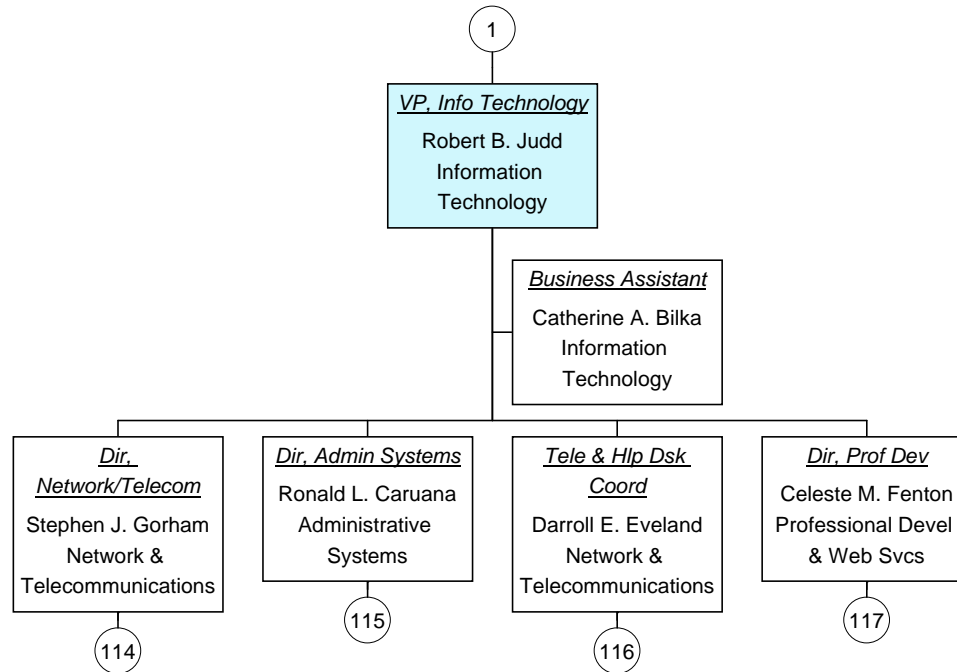

Vacant Position  
 Cabinet Position



**Dir, Network/Telecom As of  
10/22/2008**

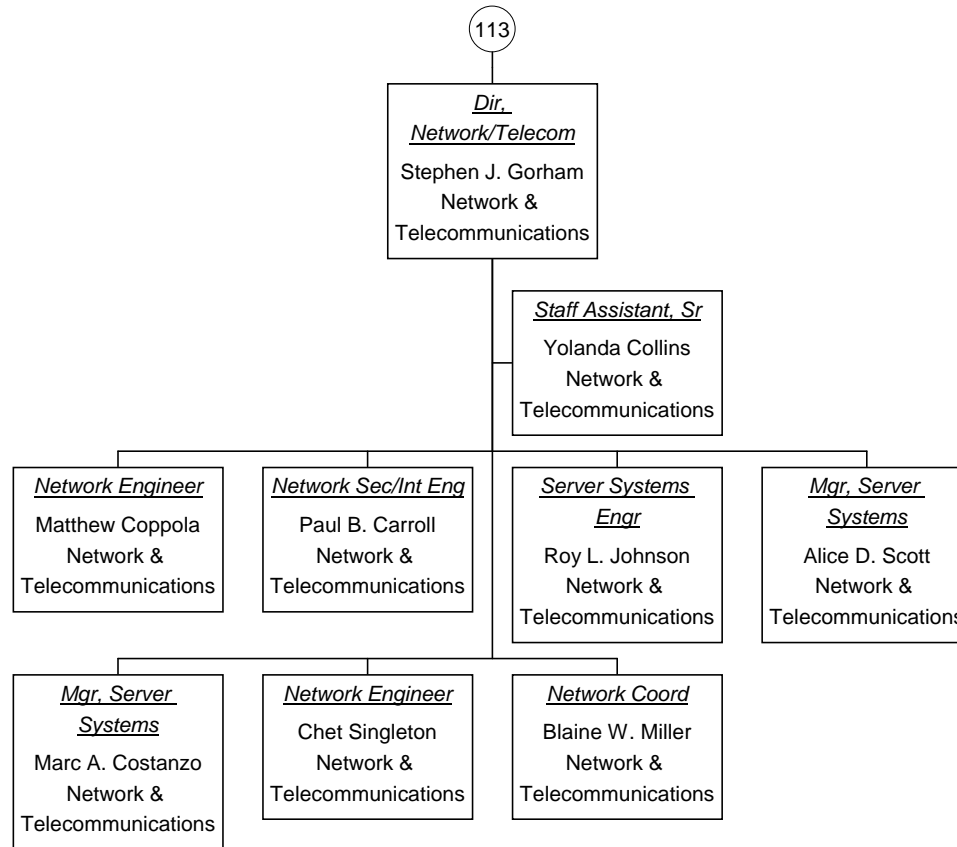

Vacant Position  
 Cabinet Position



**Dir, Admin Systems As of  
10/22/2008**

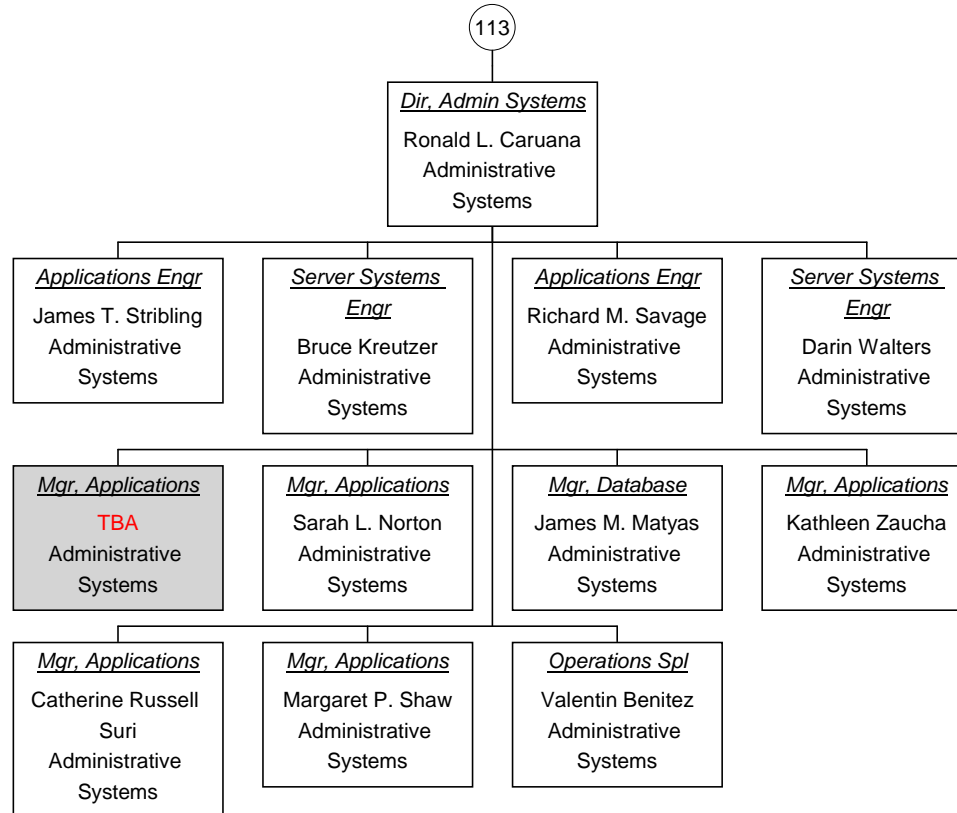

Vacant Position  
 Cabinet Position



**Tele & Hlp Dsk Coord As of  
10/22/2008**

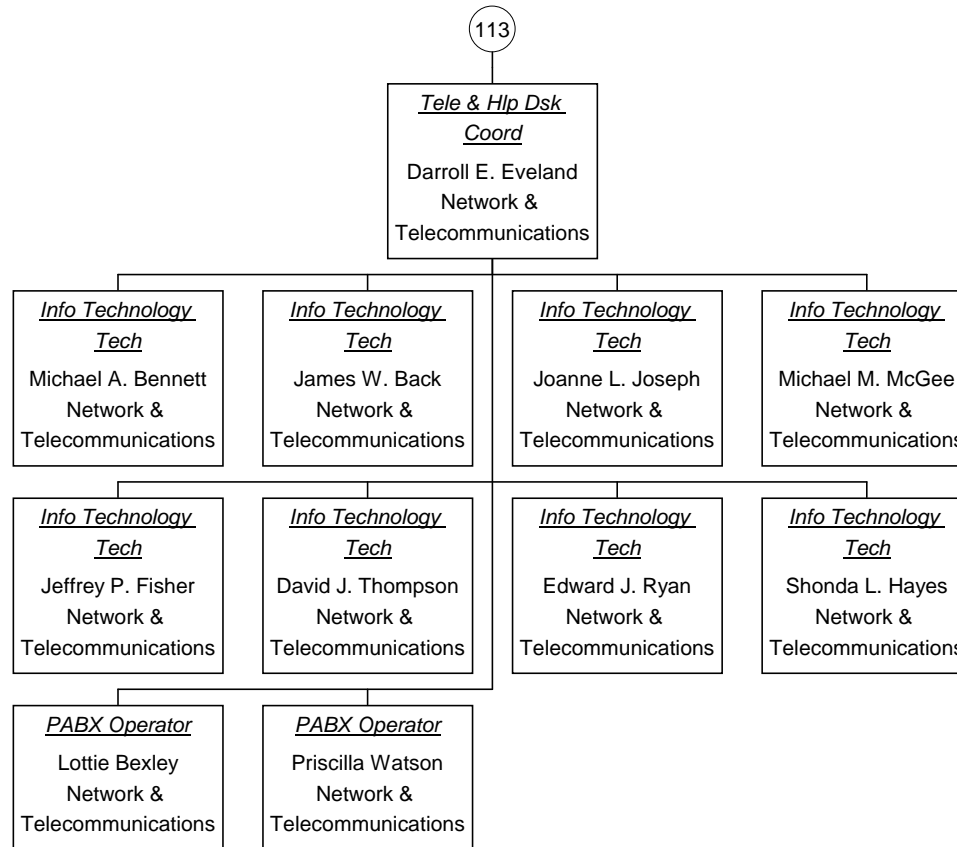

Vacant Position  
 Cabinet Position



Dir, Prof Dev As of 10/22/2008

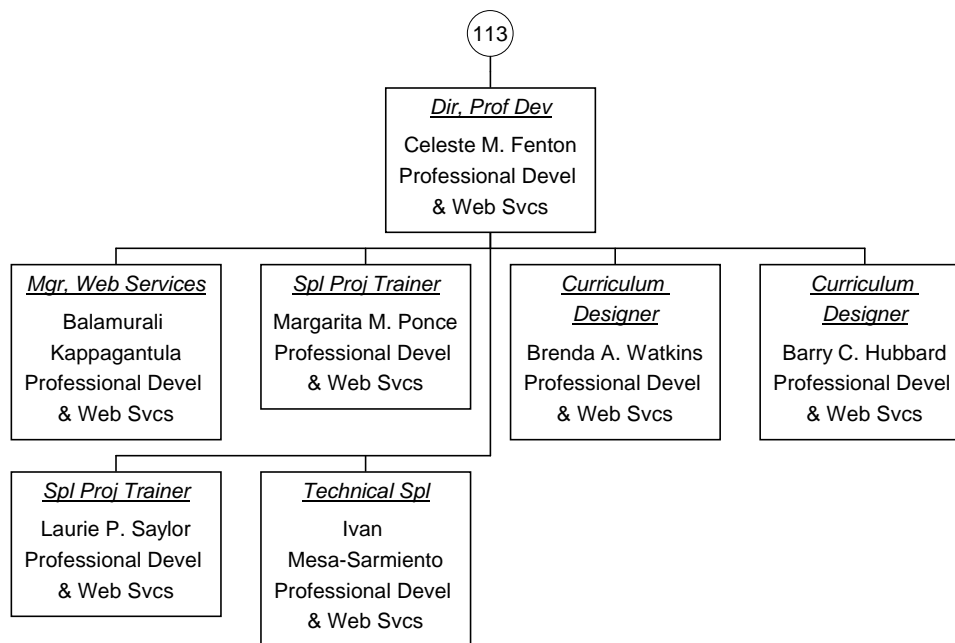

Vacant Position  
Cabinet Position



**Spl Asst to Pres As of  
10/22/2008**

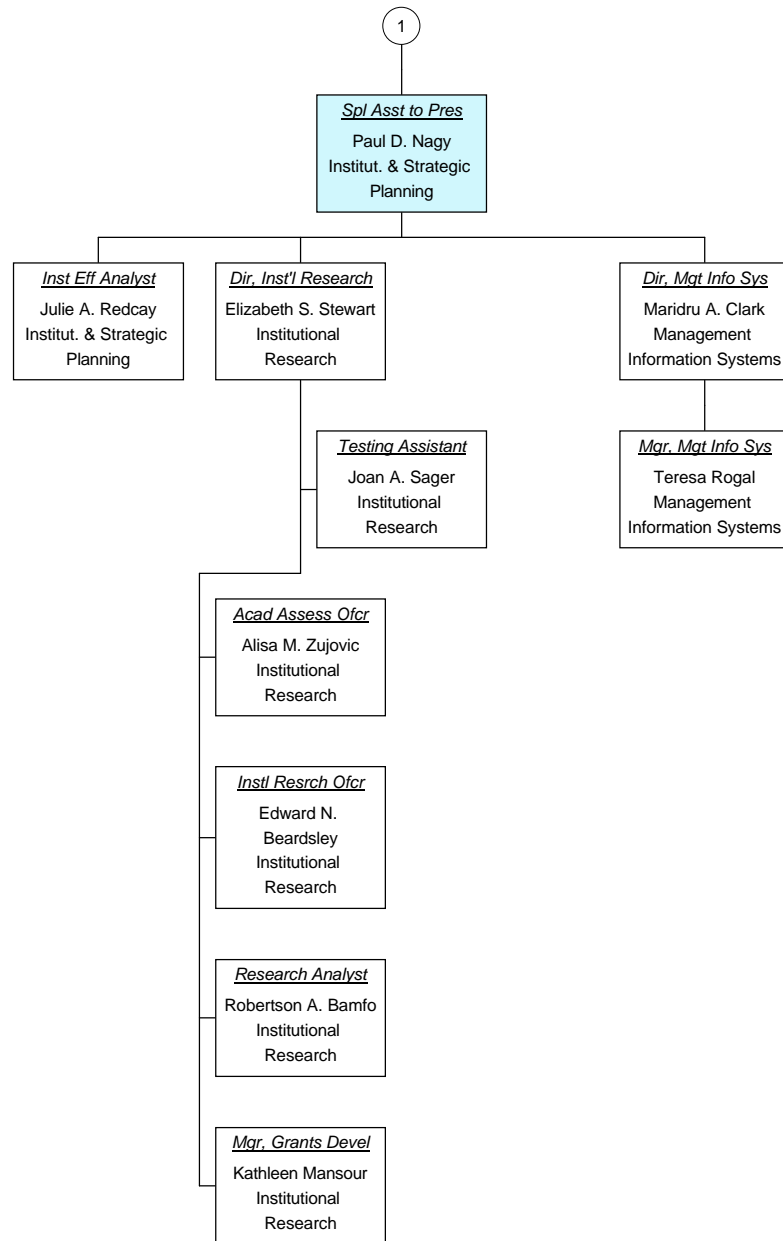

Vacant Position  
Cabinet Position



**ExDir, Human Rsrcs As of  
10/22/2008**

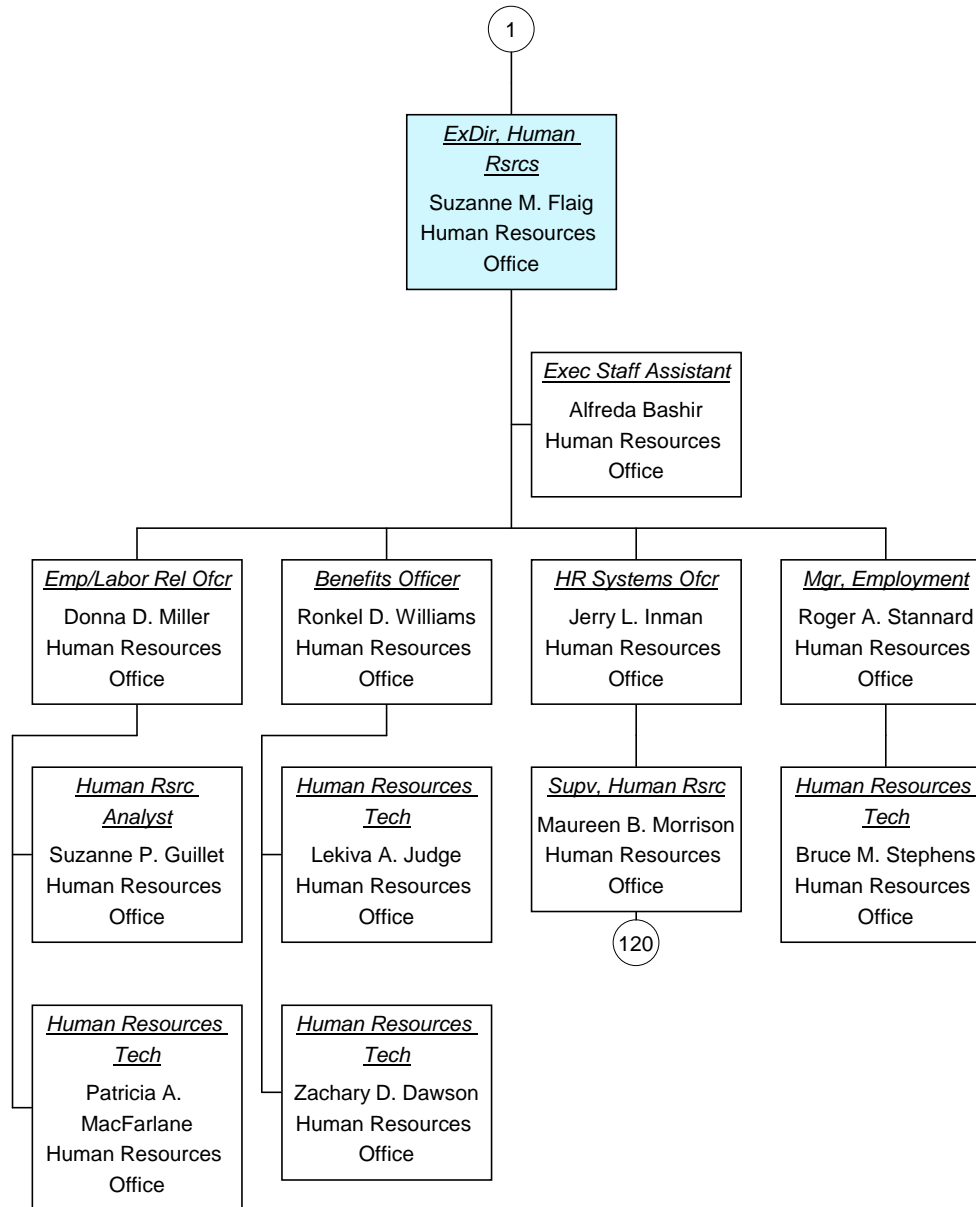

Vacant Position  
 Cabinet Position



Supv, Human Rsrc As of 10/22/2008

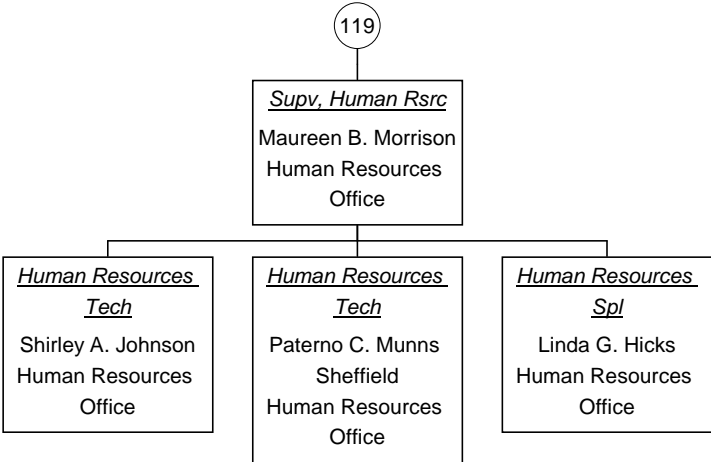

Vacant Position  
 Cabinet Position



**ExDir, Mktg & PubRel As of  
10/22/2008**

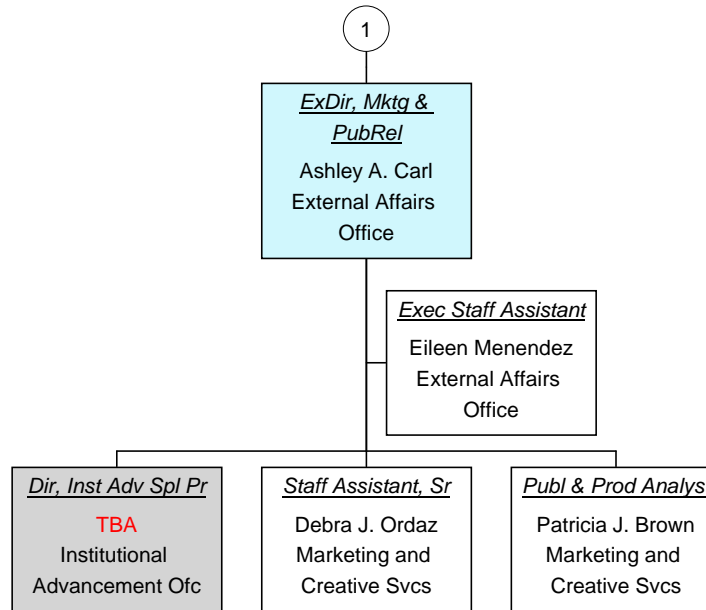

Vacant Position  
 Cabinet Position



### Exdir, Foundation As of 10/22/2008

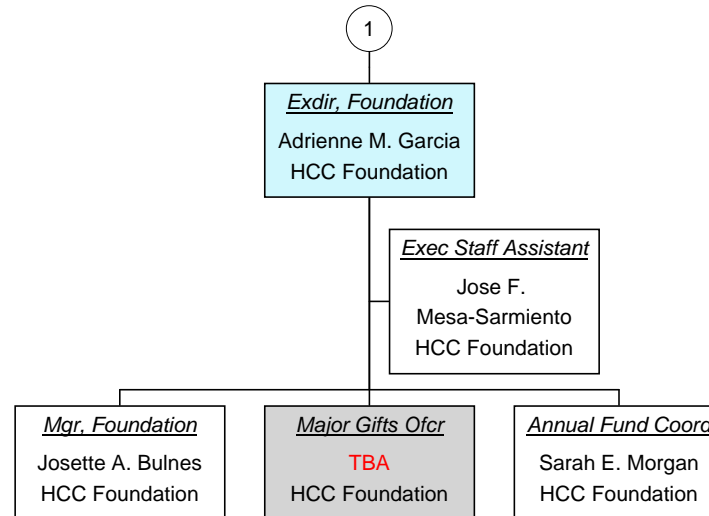

■ Vacant Position  
■ Cabinet Position